

High Power RF LDMOS Field Effect Transistor 4 W, 28 V, 700 – 2200 MHz

Description

The PTFA220041M is an unmatched 4-watt LDMOS FET intended for power amplifier applications in the 700 MHz to 2200 MHz operating range. This LDMOS device offers excellent gain, efficiency and linearity performance in a small, overmolded plastic package.

PTFA220041M
Package PG-SON-10

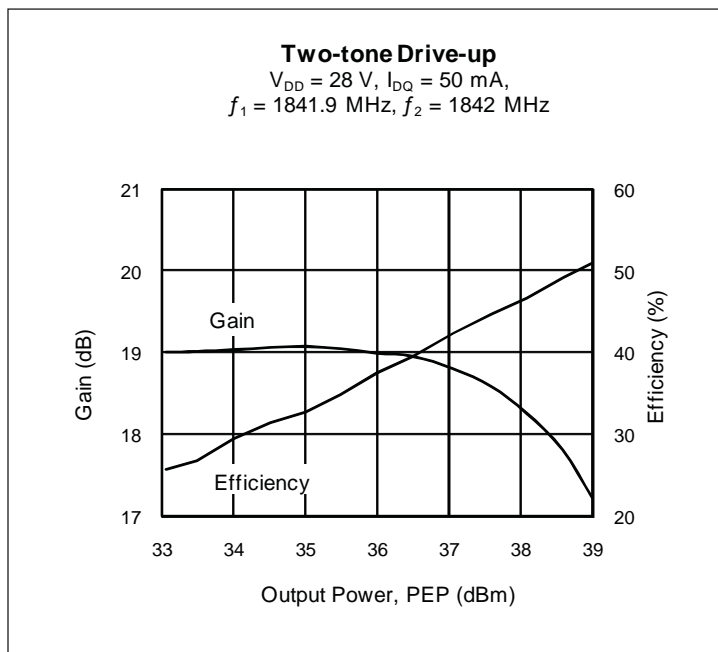

Features

- Typical two-carrier WCDMA performance, 1842 MHz, 8 dB PAR
 - $P_{OUT} = 27\text{ dBm Avg}$
 - ACPR = -44 dBc
- Typical CW performance, 1842 MHz, 28 V
 - $P_{OUT} = 37\text{ dBm}$
 - Efficiency = 53.5%
 - Gain = 17.9 dB
- Typical CW performance, 940 MHz, 28 V
 - $P_{OUT} = 37.5\text{ dBm}$
 - Efficiency = 57%
 - Gain = 19.7 dB
- Capable of handling 10:1 VSWR @ 28 V, 5 W (CW) output power
- Integrated ESD protection
- Excellent thermal stability
- Pb-free and RoHS compliant

RF Characteristics

Two-tone Measurements (not subject to production test - verified by design / characterization in Infineon test fixture)

$V_{DD} = 28\text{ V}$, $I_{DQ} = 50\text{ mA}$, $P_{OUT} = 4\text{ W PEP}$, $f = 1842\text{ MHz}$, tone spacing = 1 MHz

Characteristic	Symbol	Min	Typ	Max	Unit
Gain	G_{ps}	18.5	19	—	dB
Drain Efficiency	η_D	35	37.5	—	%
Intermodulation Distortion	IMD	—	-29	-28	dBc
Input Return Loss	IRL	—	-8	-7	dB

All published data at $T_{CASE} = 25^\circ\text{C}$ unless otherwise indicated

ESD: Electrostatic discharge sensitive device—observe handling precautions!

RF Characteristics (cont.)

Two-tone Measurements (not subject to production test - verified by design / characterization in Infineon test fixture)
 $V_{DD} = 28\text{ V}$, $I_{DQ} = 50\text{ mA}$, $P_{OUT} = 5\text{ W PEP}$, $f = 940\text{ MHz}$, tone spacing = 1 MHz

Characteristic	Symbol	Min	Typ	Max	Unit
Gain	G_{ps}	—	18.5	—	dB
Drain Efficiency	η_D	—	37	—	%
Intermodulation Distortion	IMD	—	-30	—	dBc
Input Return Loss	IRL	—	-10	—	dB

DC Characteristics

Characteristic	Conditions	Symbol	Min	Typ	Max	Unit
Drain-Source Breakdown Voltage	$V_{GS} = 0\text{ V}$, $I_{DS} = 10\text{ }\mu\text{A}$	$V_{(BR)DSS}$	65	—	—	V
Drain Leakage Current	$V_{DS} = 28\text{ V}$, $V_{GS} = 0\text{ V}$	I_{DSS}	—	—	1.0	μA
On-State Resistance	$V_{GS} = 10\text{ V}$, $V_{DS} = 0.1\text{ A}$	$R_{DS(on)}$	—	2.01	—	Ω
Operating Gate Voltage	$V_{DS} = 28\text{ V}$, $I_{DQ} = 50\text{ mA}$	V_{GS}	2.1	2.7	3.1	V
Gate Leakage Current	$V_{GS} = 10\text{ V}$, $V_{DS} = 0\text{ V}$	I_{GSS}	—	—	1.0	μA

Maximum Ratings

Parameter	Symbol	Value	Unit
Drain-Source Voltage	V_{DSS}	65	V
Gate-Source Voltage	V_{GS}	-0.5 to +12	V
Junction Temperature	T_J	175	$^{\circ}\text{C}$
Storage Temperature Range	T_{STG}	-40 to +150	$^{\circ}\text{C}$
Thermal Resistance ($T_{CASE} = 70^{\circ}\text{C}$, 5 W CW)	$R_{\theta JC}$	5.5	$^{\circ}\text{C/W}$

Moisture Sensitivity Level

Level	Test Standard	Package Temperature	Temperature Unit
3	IPC/JEDEC J-STD-020	260	$^{\circ}\text{C}$

Ordering Information

Type and Version	Order Code	Package and Description	Shipping
PTFA220041M V4 R1K	PTFA220041MV4R1KXUMA1	PG-SON-10, molded plastic, SMD	Tape & Reel, 1,000 pcs

Typical Performance, 1842 MHz (data taken in Infineon test fixture)

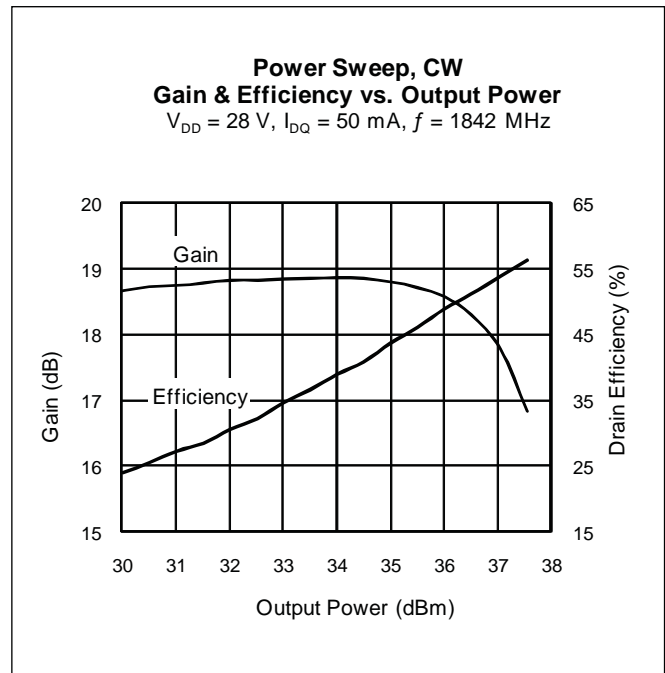
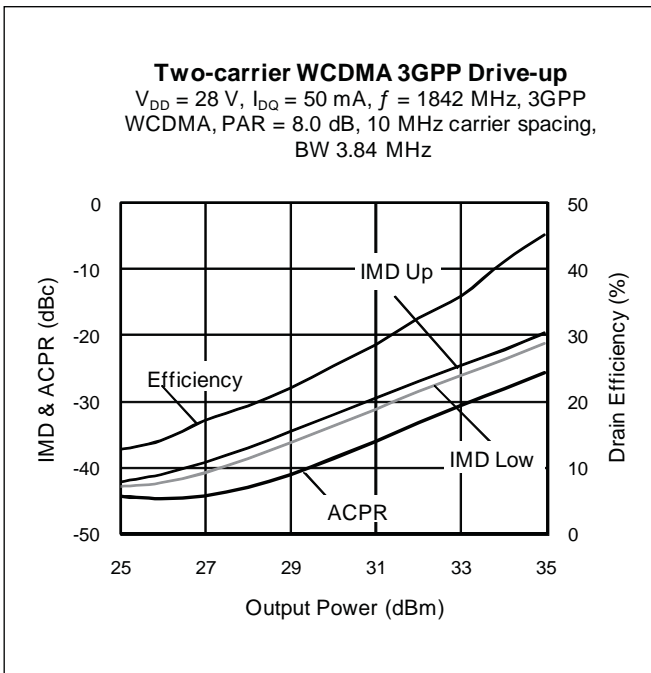
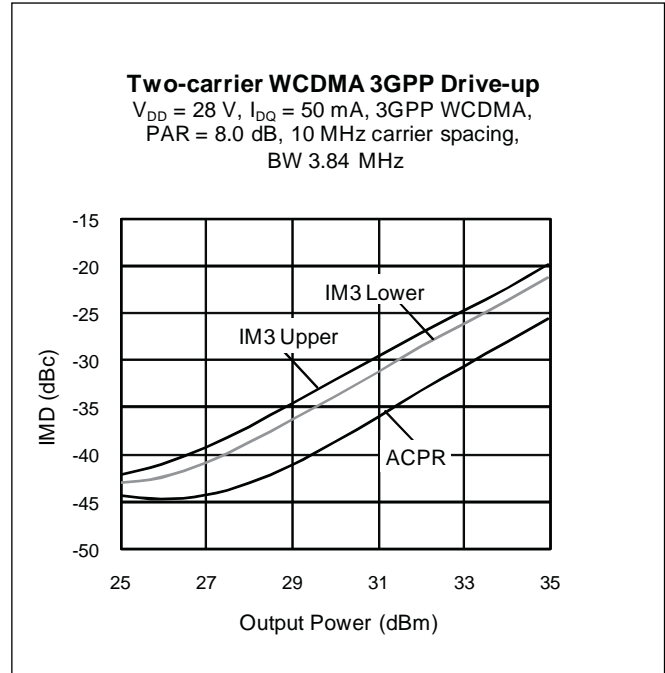
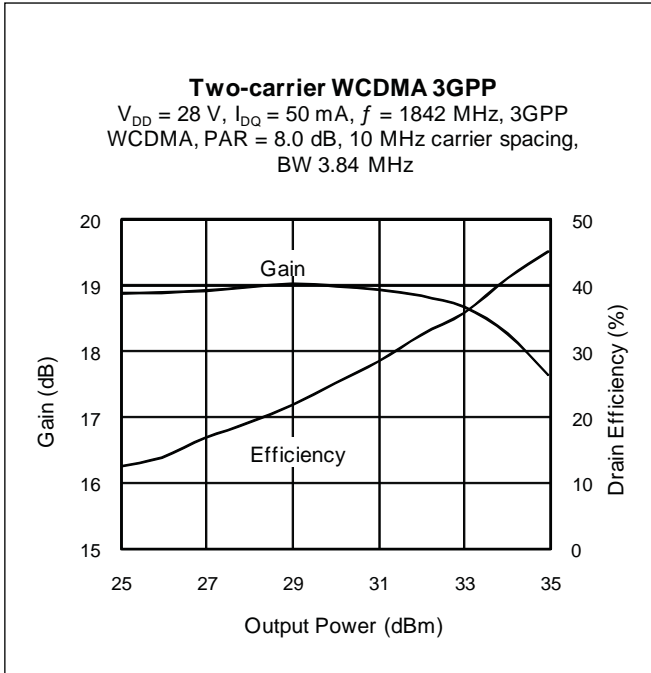

Typical Performance, 1842 MHz (cont.)

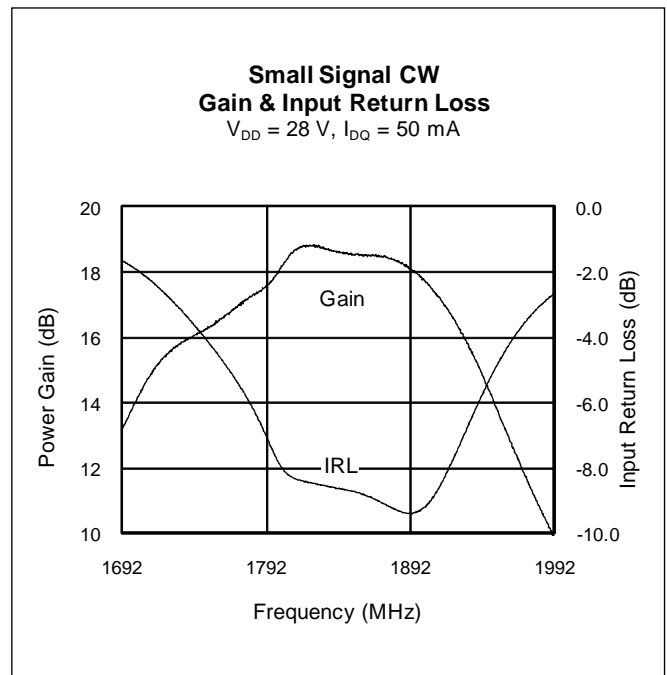
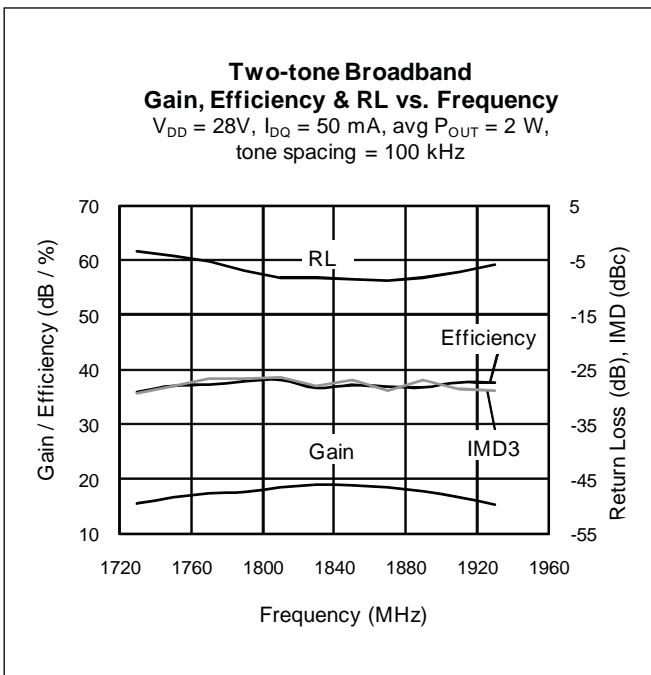
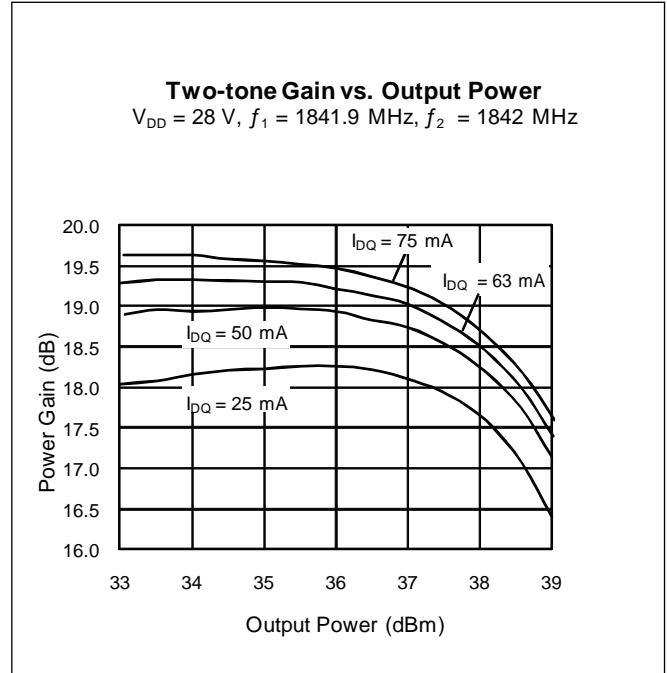
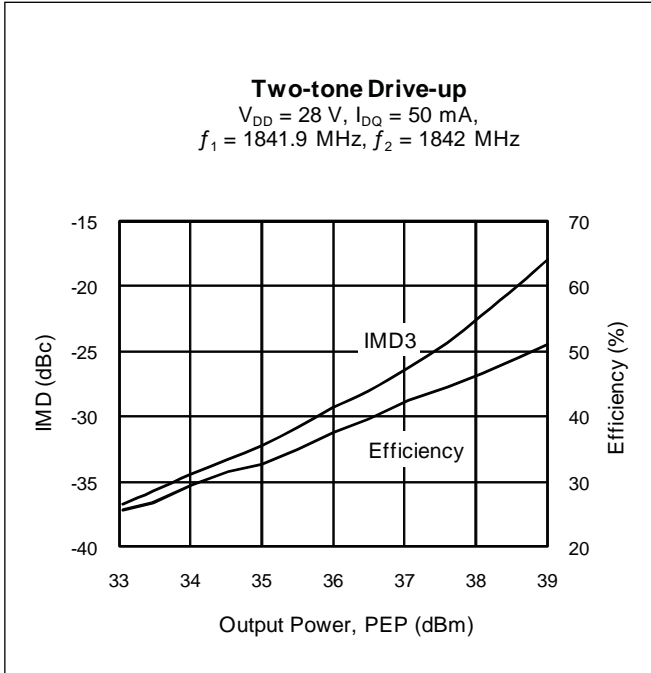

Typical Performance, 1842 MHz (cont.)

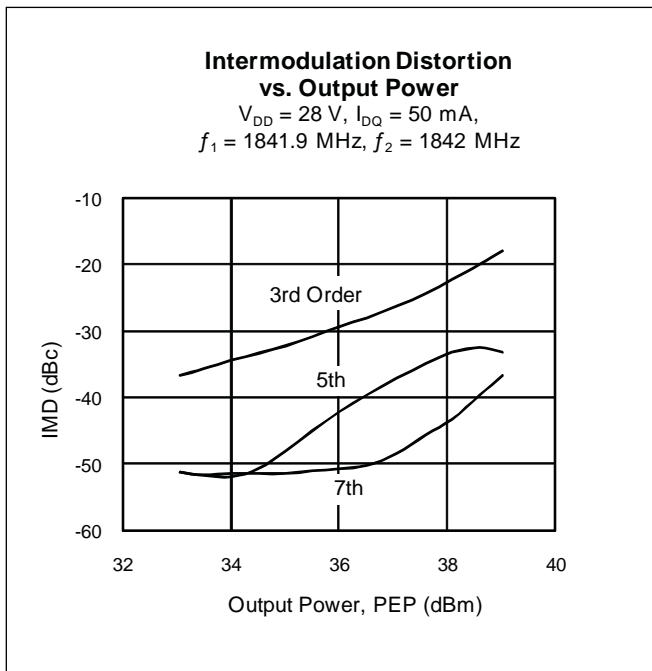
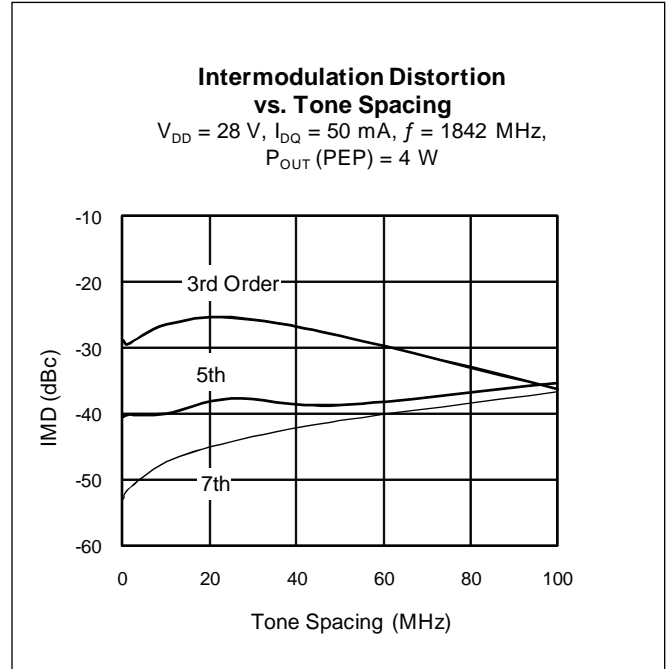
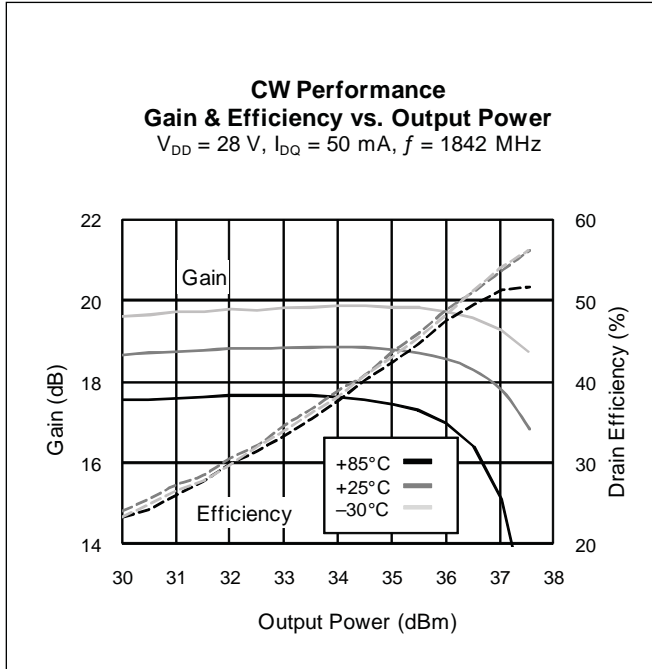

Broadband Circuit Impedance, 1842 MHz

Frequency MHz	Z Source Ω		Z Load Ω	
	R	jX	R	jX
720	2.4	16.9	45.2	25.2
820	1.8	13.4	31.0	15.2
869	1.6	11.8	21.3	18.2
894	1.6	12.0	22.1	18.4
920	1.6	10.6	14.5	21.5
940	1.6	10.1	15.2	21.4
960	1.6	10.3	16.1	18.9
1805	2.1	3.2	6.8	12.1
1880	2.1	2.2	6.4	10.9
1930	1.8	1.3	6.3	10.6
1990	2.1	1.5	4.3	8.1
2110	2.5	2.0	4.9	8.4
2170	2.0	2.0	4.4	8.8

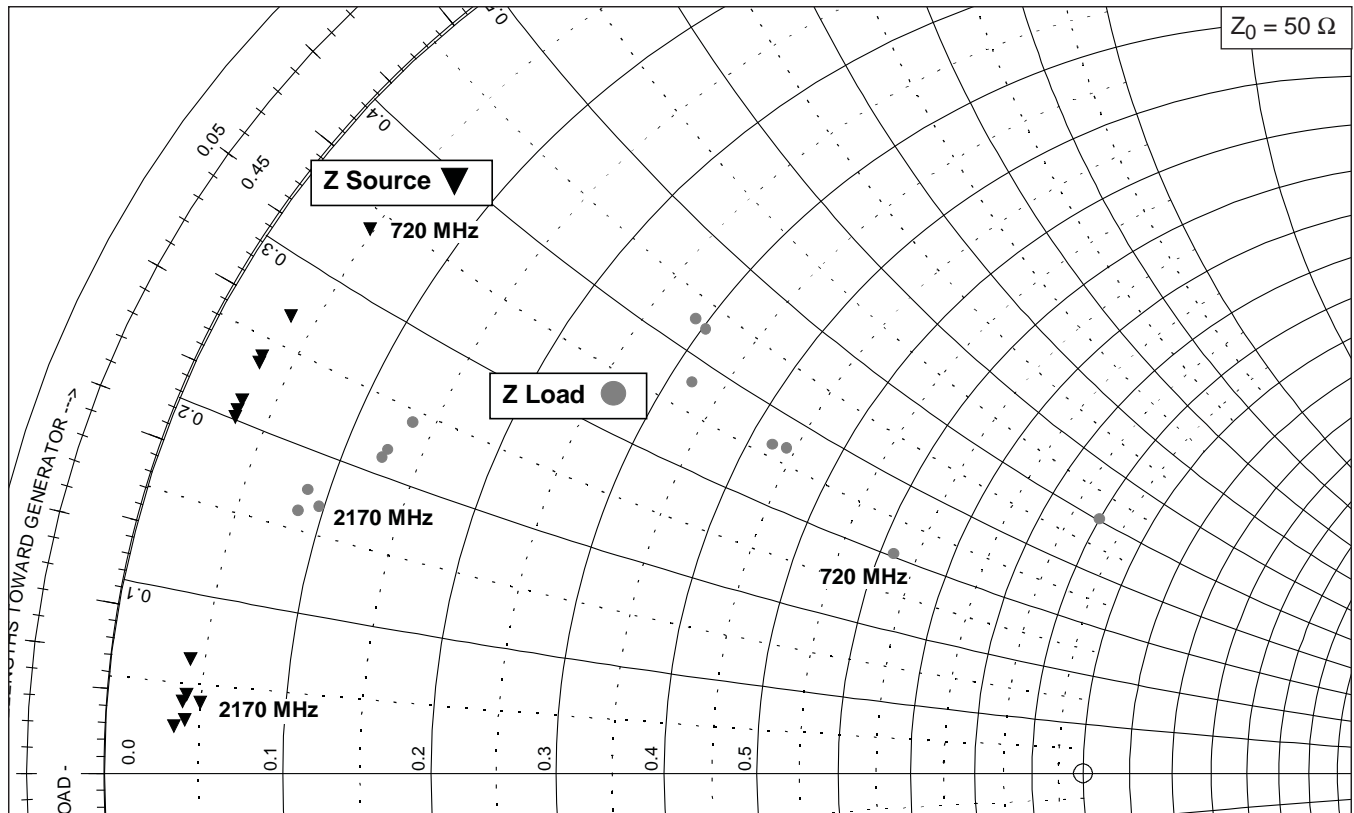
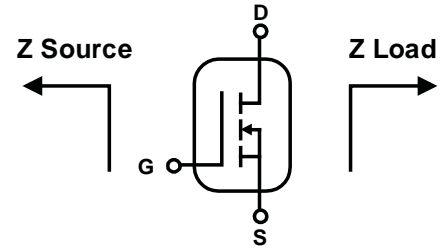

Reference Circuit, 1842 MHz

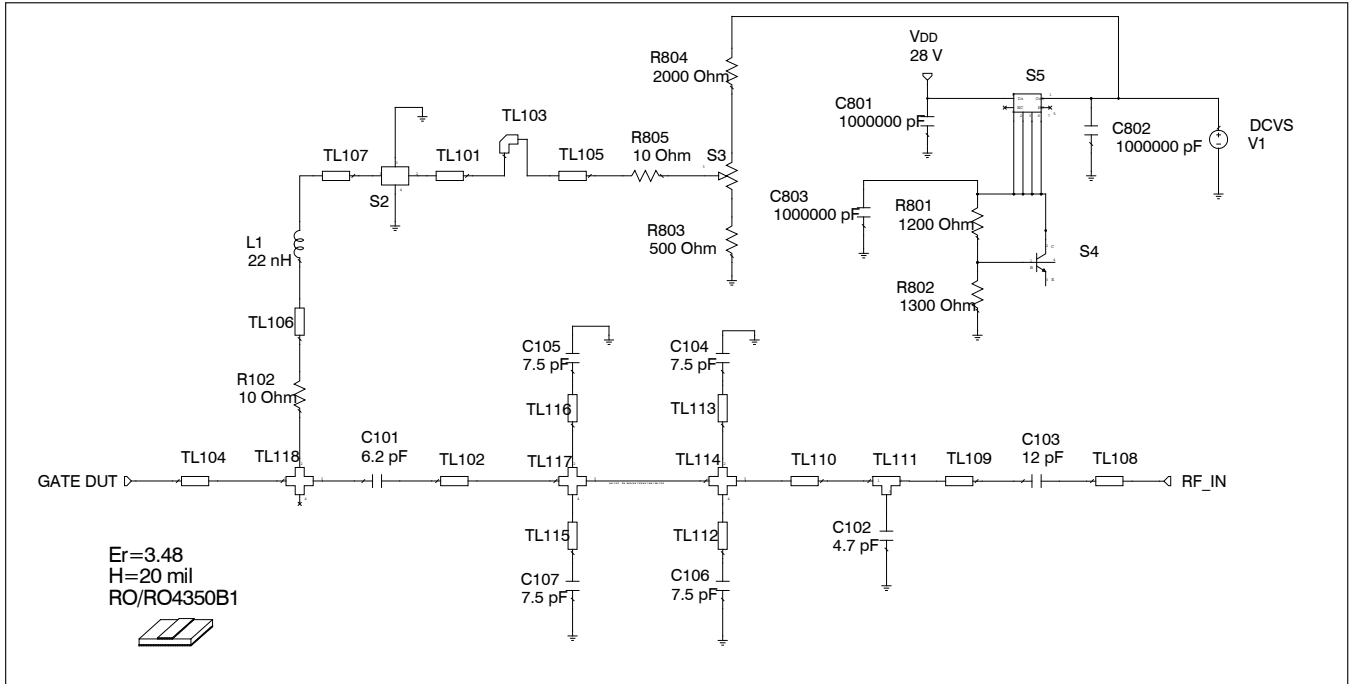

Reference circuit input schematic for $f = 1842$ MHz

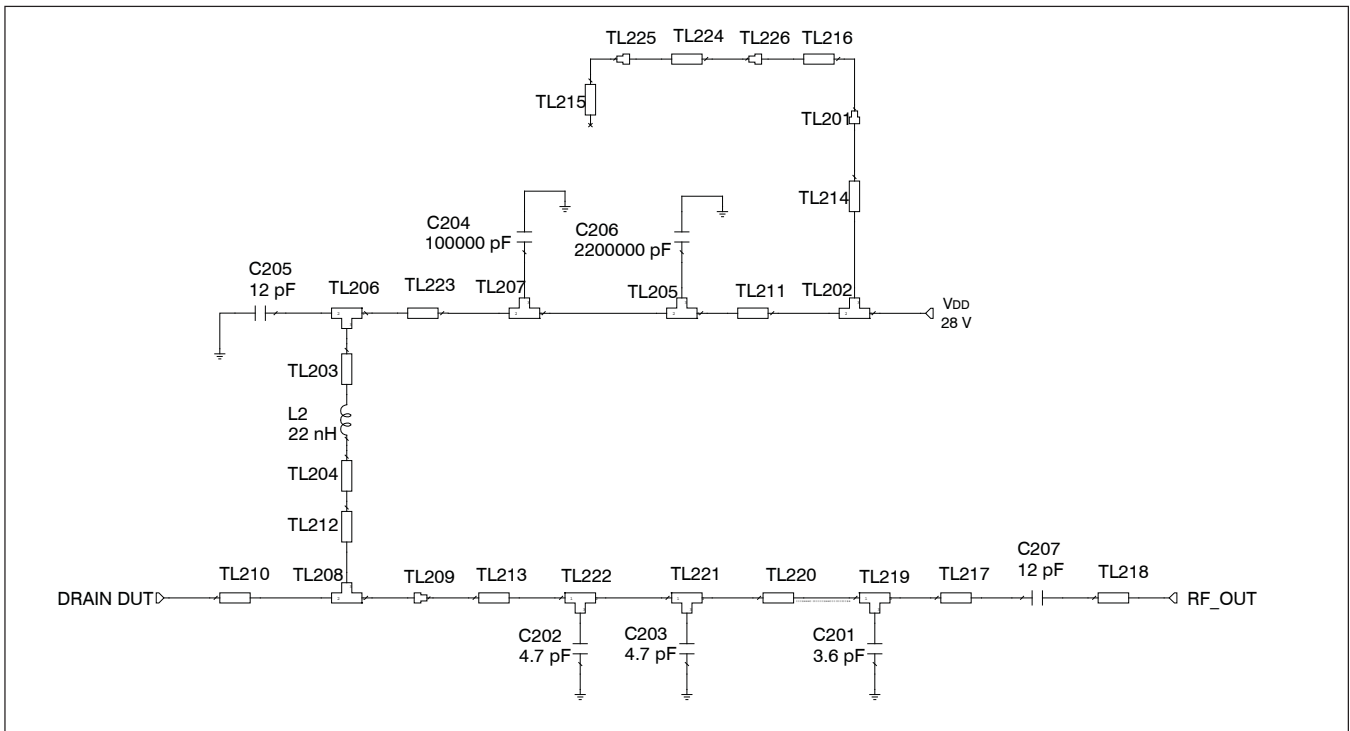

Reference circuit output schematic for $f = 1842$ MHz

Reference Circuit, 1842 MHz (cont.)
Electrical Characteristics at 1842 MHz

Transmission Line	Electrical Characteristics	Dimensions: mm	Dimensions: mils
Input			
TL101	0.005 λ , 41.75 Ω	W = 1.524, L = 0.508	W = 60, L = 20
TL102	0.021 λ , 51.98 Ω	W = 1.087, L = 2.108	W = 43, L = 83
TL103		W = 1.524	W = 60
TL104	0.019 λ , 25.04 Ω	W = 3.048, L = 1.778	W = 120, L = 70
TL105	0.052 λ , 41.75 Ω	W = 1.524, L = 5.08	W = 60, L = 200
TL106	0.013 λ , 41.75 Ω	W = 1.524, L = 1.27	W = 60, L = 50
TL107	0.015 λ , 54.17 Ω	W = 1.016, L = 1.524	W = 40, L = 60
TL108	0.033 λ , 51.98 Ω	W = 1.087, L = 3.264	W = 43, L = 129
TL109	0.149 λ , 51.98 Ω	W = 1.087, L = 14.681	W = 43, L = 578
TL110	0.034 λ , 51.98 Ω	W = 1.087, L = 3.378	W = 43, L = 133
TL111	0.008 λ , 51.98 Ω	W1 = 1.087, W2 = 1.087, W3 = 0.813	W1 = 43, W2 = 43, W3 = 32
TL112, TL113, TL115, TL116		W = 0, L = 0	W = 0, L = 0
TL114, TL 117		W1 = 1.087, W2 = 0.813, W3 = 1.087 W4 = 0.813	W1 = 43, W2 = 32, W3 = 43, W4 = 32
TL118		W1 = 3.048, W2 = 0.762, W3 = 3.048, W4 = 0.762	W1 = 120, W2 = 30, W3 = 120, W4 = 30
Output			
TL201, TL225, TL226		W1 = 0.025, W2 = 0.025	W1 = 1, W2 = 1
TL202	0.013 λ , 41.75 Ω	W1 = 1.524, W2 = 1.524, W3 = 1.27	W1 = 60, W2 = 60, W3 = 50
TL203	0.005 λ , 41.75 Ω	W = 1.524, L = 0.508	W = 60, L = 20
TL204	0.016 λ , 41.75 Ω	W = 1.524, L = 1.524	W = 60, L = 60
TL205	0.039 λ , 41.75 Ω	W1 = 1.524, W2 = 1.524, W3 = 3.81	W1 = 60, W2 = 60, W3 = 150
TL206, TL207	0.016 λ , 41.75 Ω	W1 = 1.524, W2 = 1.524, W3 = 1.524	W1 = 60, W2 = 60, W3 = 60
TL208	0.008 λ , 25.04 Ω	W1 = 3.048, W2 = 3.048, W3 = 0.762	W1 = 120, W2 = 120, W3 = 30
TL209		W = 1.087, W2 = 3.048	W = 43, W2 = 120
TL210	0.019 λ , 25.04 Ω	W = 3.048, L = 1.778	W = 120, L = 70
TL211	0.014 λ , 41.75 Ω	W = 1.524, L = 1.346	W = 60, L = 53
TL212	0.013 λ , 63.89 Ω	W = 0.762, L = 1.27	W = 30, L = 50
TL213	0.031 λ , 51.98 Ω	W = 1.087, L = 3.073	W = 43, L = 121
TL214	0.163 λ , 47.12 Ω	W = 1.27, L = 15.926	W = 50, L = 627
TL215	0.074 λ , 47.12 Ω	W = 1.27, L = 7.29	W = 50, L = 287
TL216	0.076 λ , 15.92 Ω	W = 5.283, L = 6.986	W = 208, L = 275
TL217	0.123 λ , 51.98 Ω	W = 1.087, L = 12.103	W = 43, L = 477
TL218	0.033 λ , 51.98 Ω	W = 1.087, L = 3.264	W = 43, L = 129
TL219, TL221, TL222	0.008 λ , 51.98 Ω	W1 = 1.087, W2 = 1.087, W3 = 0.813	W1 = 43, W2 = 43, W3 = 32
TL220	0.060 λ , 51.98 Ω	W = 1.087, L = 5.867	W = 43, L = 231
TL223	0.016 λ , 41.75 Ω	W = 1.524, L = 1.524	W = 60, L = 60
TL224	0.149 λ , 47.12 Ω	W = 1.27, L = 14.554	W = 50, L = 573

Reference Circuit, 1842 MHz (cont.)

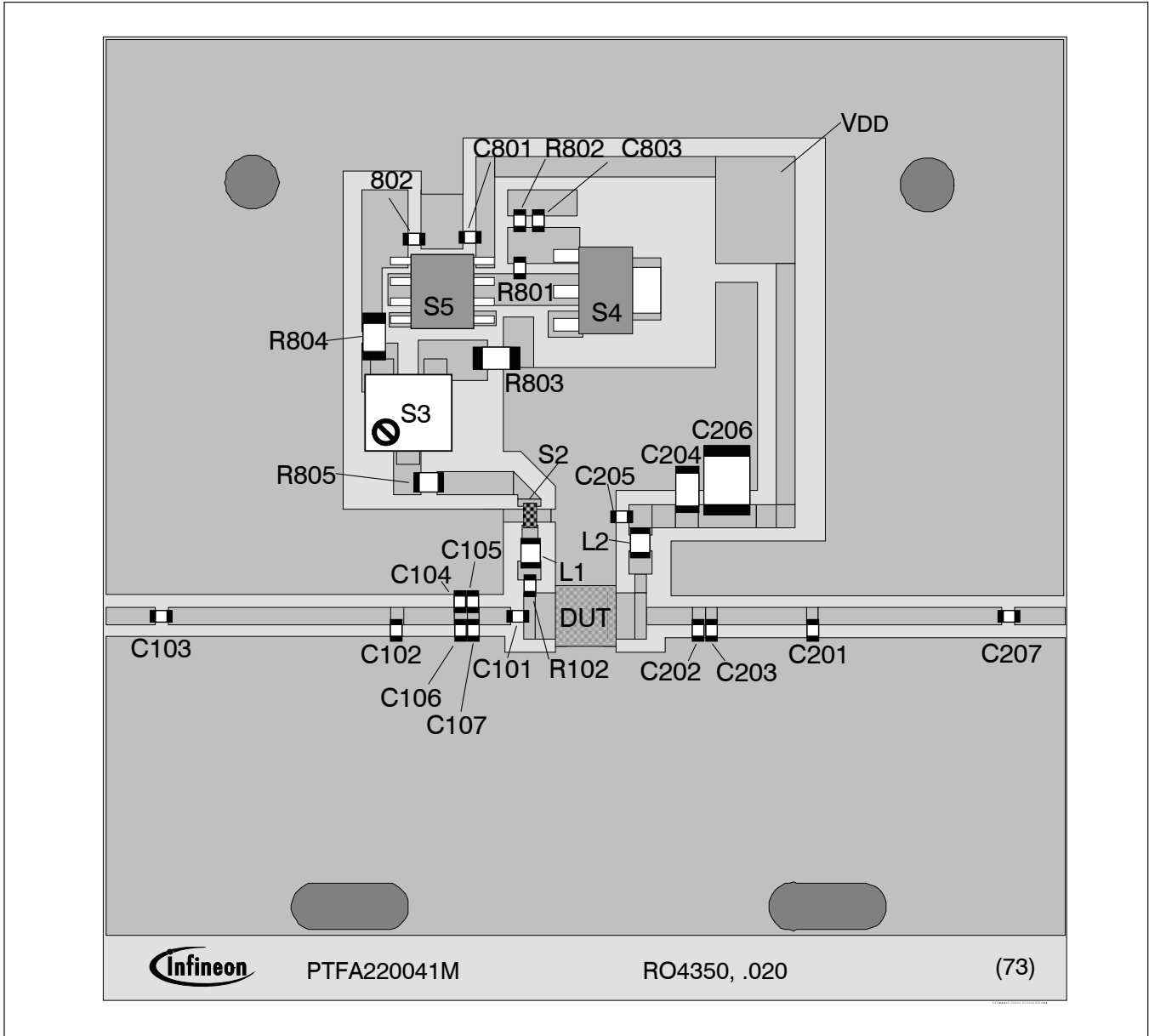

Reference circuit assembly diagram (not to scale)

Reference Circuit, 1842 MHz (cont.)
Circuit Assembly Information

DUT	PTFA220041M	LDMOS Transistor	
PCB	LTN/PTFA220041M	0.508 mm [.020"] thick, $\epsilon_r = 3.48$	Rogers 4350, 1 oz. copper

Find Gerber files for this test fixture on the Infineon Web site at www.infineon.com/rfpower

Component	Description	Manufacturer	P/N
Input			
C101	Chip capacitor, 6.2 pF	ATC	100A6R2CW150X
C102	Chip capacitor, 4.7 pF	ATC	100A4R7CW150X
C103	Chip capacitor, 12 pF	ATC	100A120JW150X
C104, C105, C106, C107	Chip capacitor, 7.5 pF	ATC	100A7R5CW150X
C801, C802, C803	Chip capacitor, 1.0 μ F	Digi-Key	445-1411-2-ND
L1	Inductor, 22 nH	Coilcraft	0805HT-22NX_BG
R102, R805	Resistor, 10 Ω	Digi-Key	P10ECT-ND
R801	Resistor, 1200 Ω	Digi-Key	P1.2KECT-ND
R802	Resistor, 1300 Ω	Digi-Key	P1.3KECT-ND
R803	Resistor, 500 Ω	Digi-Key	P500ECT-ND
R804	Resistor, 2000 Ω	Digi-Key	P2.0KECT-ND
S2	EMI Suppression Capacitor	Murata	NFM18PS105R0J3
S3	Potentiometer, 2k Ω	Digi-Key	3224W-202ECT-ND
S4	Transistor	Infineon Technologies	BCP56
S5	Voltage regulator	National Semiconductor	LM7805

Output			
C201	Chip capacitor, 3.6 pF	ATC	100A3R6CW150X
C202, C203	Chip capacitor, 4.7 pF	ATC	100A4R7CW150X
C204	Chip capacitor, 0.1 μ F	Digi-Key	PCC104BCT-ND
C205, C207	Chip capacitor, 12 pF	ATC	100A120JW150X
C206	Chip capacitor, 2.2 μ F	Digi-Key	445-1447-2-ND
L2	Inductor, 22 nH	Coilcraft	0805HT-22NX_BG

Typical Performance, 940 MHz

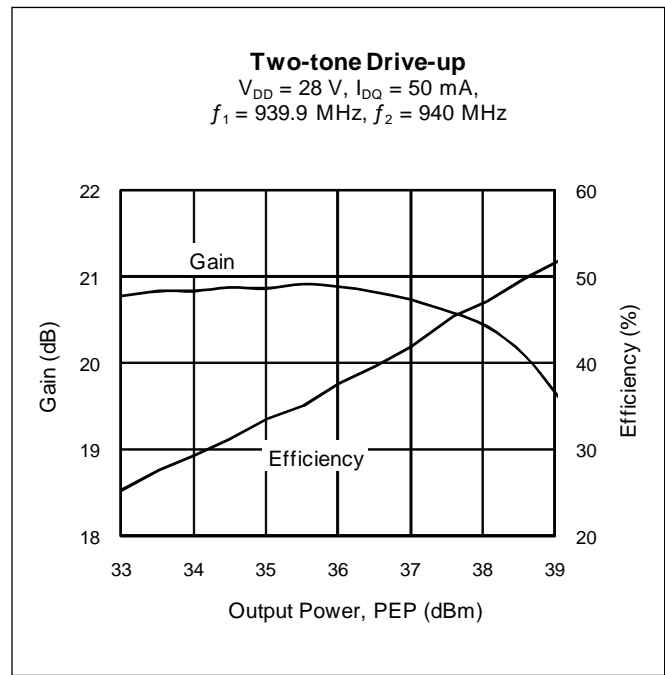
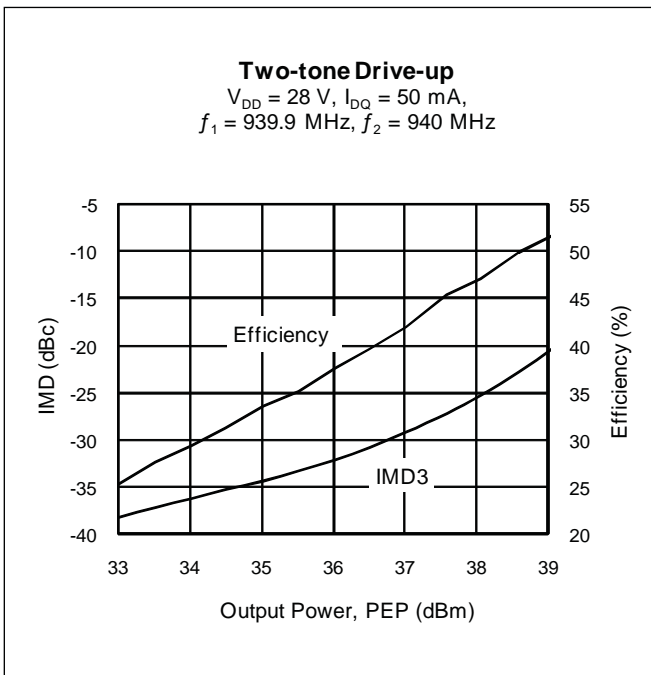
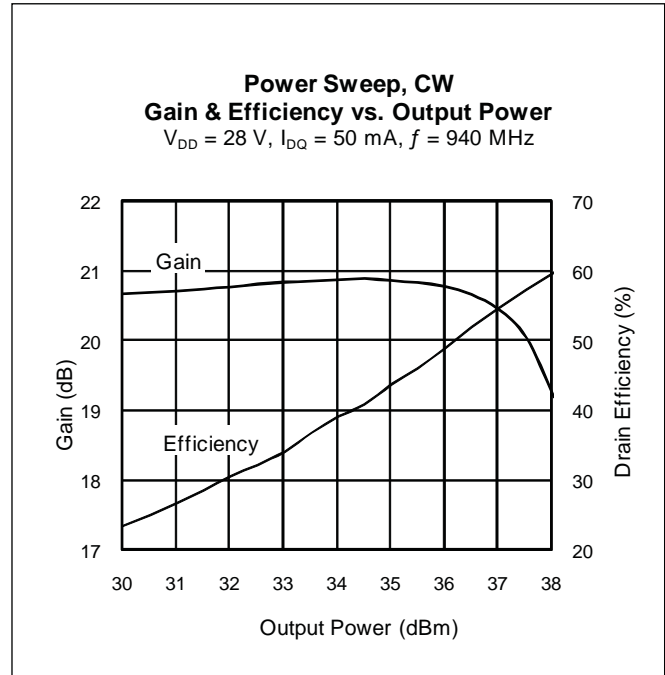
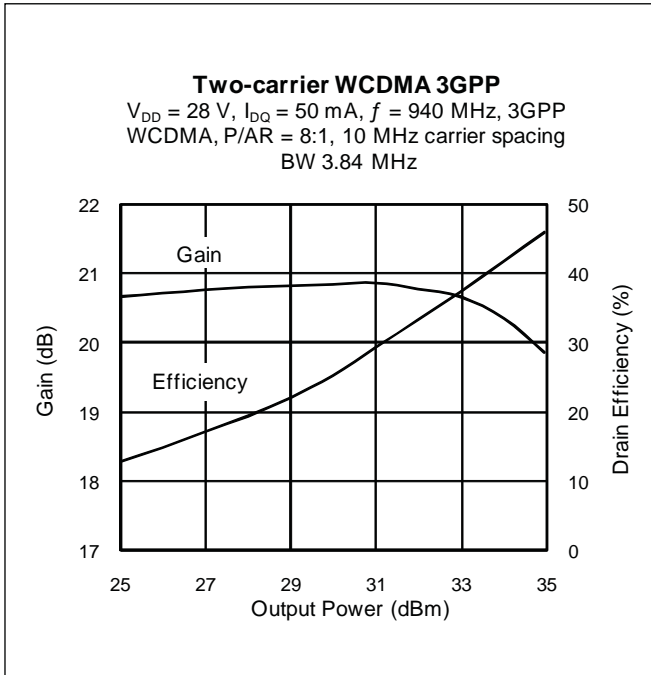

Typical Performance, 940 MHz (cont.)

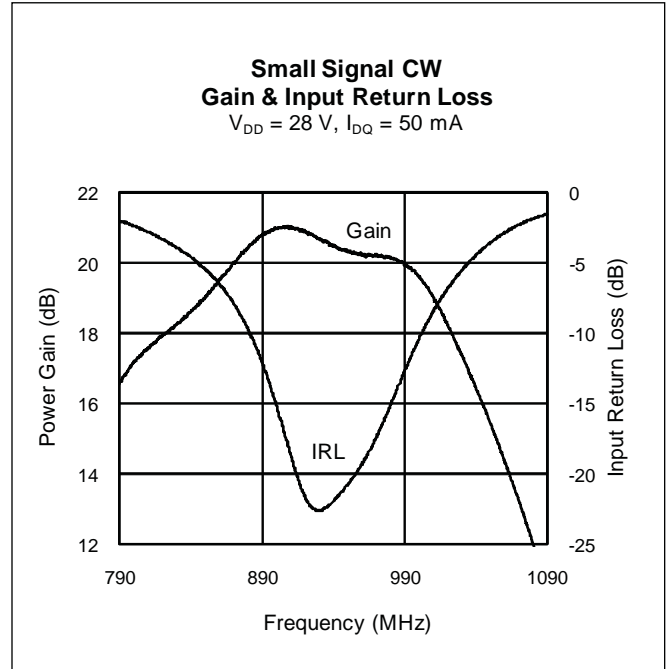
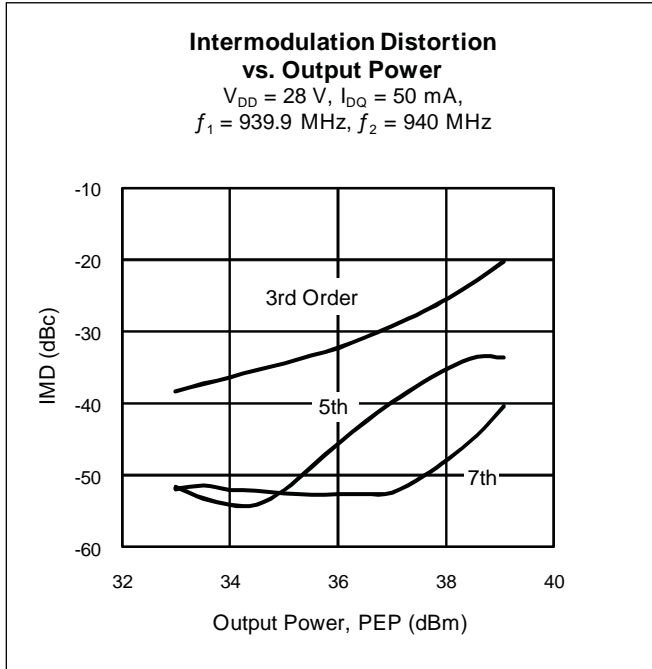

See reference circuit for 940 MHz, next page

Reference Circuit, 940 MHz

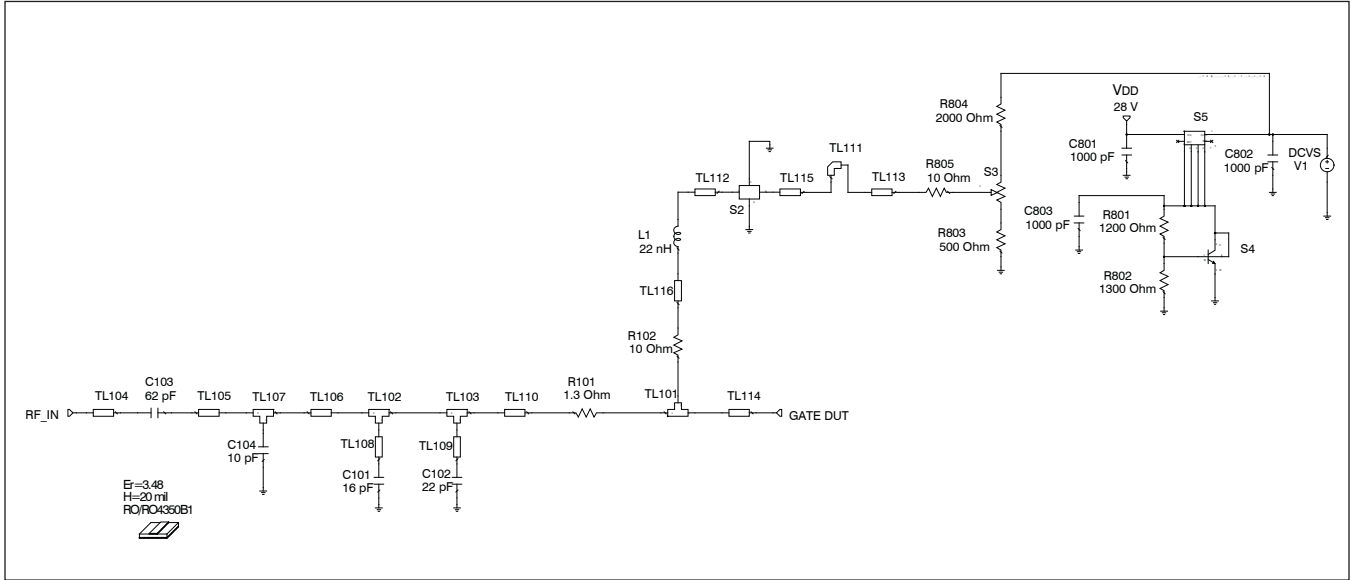

Reference circuit input schematic for $f = 940$ MHz

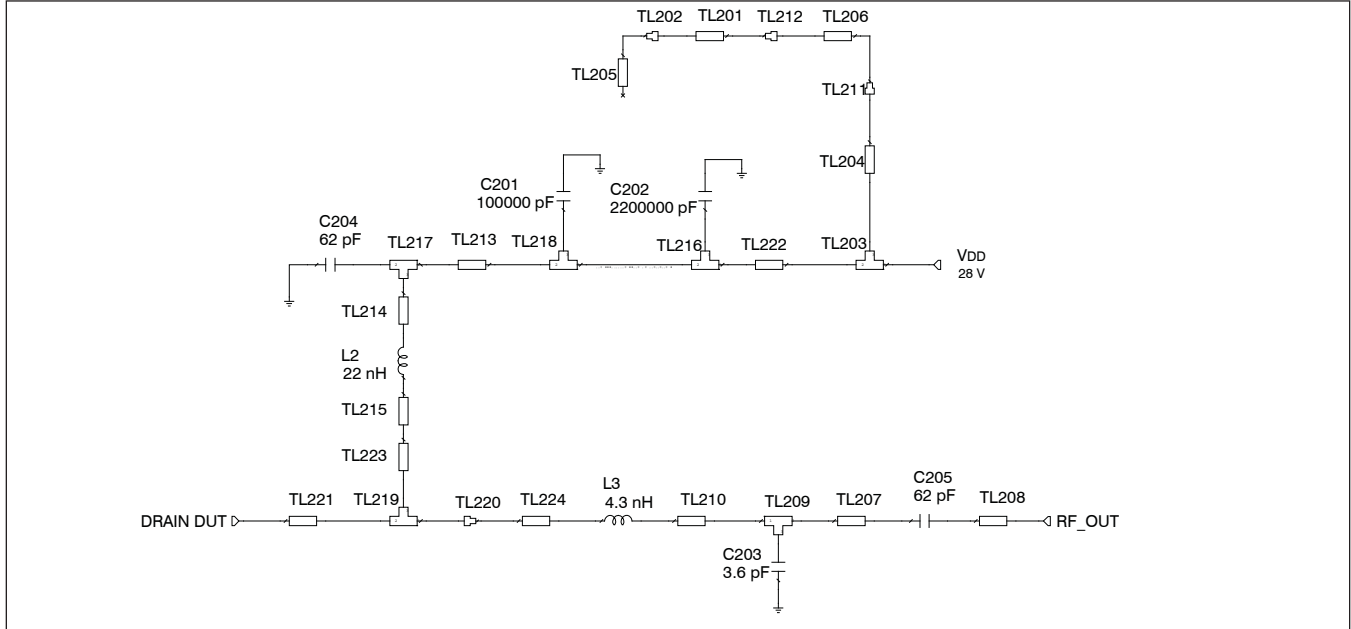

Reference circuit output schematic for $f = 940$ MHz

Reference Circuit, 940 MHz (cont.)
Electrical Characteristics at 940 MHz

Transmission Line	Electrical Characteristics	Dimensions: mm	Dimensions: mils
Input			
TL101	0.004 λ , 24.85 Ω	W1 = 3.048, W2 = 3.048, W3 = 0.762	W1 = 120, W2 = 120, W3 = 30
TL102, TL103	0.004 λ , 51.66 Ω	W1 = 1.087, W2 = 1.087, W3 = 0.813	W1 = 43, W2 = 43, W3 = 32
TL104	0.017 λ , 51.66 Ω	W = 1.087, L = 3.264	W = 43, L = 129
TL105	0.038 λ , 51.66 Ω	W = 1.087, L = 7.341	W = 43, L = 289
TL106	0.047 λ , 51.66 Ω	W = 1.087, L = 9.144	W = 43, L = 360
TL107	0.004 λ , 51.66 Ω	W1 = 1.087, W2 = 1.087, W3 = 0.762,	W1 = 43, W2 = 43, W3 = 30
TL108, TL109	0.000 λ , 144.28 Ω	W = 0.025, L = 0.000	W = 1, L = 0
TL110	0.019 λ , 51.66 Ω	W = 1.087, L = 3.734	W = 43, L = 147
TL111		W = 1.524	W = 60
TL112	0.008 λ , 53.85 Ω	W = 1.016, L = 1.524	W = 40, L = 60
TL113	0.027 λ , 41.47 Ω	W = 1.524, L = 5.080	W = 60, L = 200
TL114	0.010 λ , 24.85 Ω	W = 3.048, L = 1.778	W = 120, L = 70
TL115	0.003 λ , 41.47 Ω	W = 1.524, L = 0.508	W = 60, L = 20
TL116	0.007 λ , 41.47 Ω	W = 1.524, L = 1.270	W = 60, L = 50
Output			
TL201	0.076 λ , 46.82 Ω	W = 1.270, L = 14.554	W = 50, L = 573
TL202		W1 = 0.025, W2 = 0.025	W1 = 1, W2 = 1
TL203	0.007 λ , 41.47 Ω	W1 = 1.524, W2 = 1.524, W3 = 1.270	W1 = 60, W2 = 60, W3 = 50
TL204	0.083 λ , 46.82 Ω	W = 1.270, L = 15.927	W = 50, L = 627
TL205	0.038 λ , 46.82 Ω	W = 1.270, L = 7.290	W = 50, L = 287
TL206	0.039 λ , 15.79 Ω	W = 5.283, L = 6.986	W = 208, L = 275
TL207	0.063 λ , 51.66 Ω	W = 1.087, L = 12.103	W = 43, L = 477
TL208	0.017 λ , 51.66 Ω	W = 1.087, L = 3.264	W = 43, L = 129
TL209	0.004 λ , 51.66 Ω	W1 = 1.087, W2 = 1.087, W3 = 0.813	W1 = 43, W2 = 43, W3 = 32
TL210	0.046 λ , 51.66 Ω	W = 1.087, L = 8.852	W = 43, L = 349
TL211, TL212		W1 = 0.025, W2 = 0.025	W1 = 1, W2 = 1
TL213, TL215	0.008 λ , 41.47 Ω	W = 1.524, L = 1.524	W = 60, L = 60
TL214	0.003 λ , 41.47 Ω	W = 1.524, L = 0.508	W = 60, L = 20
TL216	0.020 λ , 41.47 Ω	W1 = 1.524, W2 = 1.524, W3 = 3.810	W1 = 60, W2 = 60, W3 = 150
TL217, TL218	0.008 λ , 41.47 Ω	W1 = 1.524, W2 = 1.524, W3 = 1.524	W1 = 60, W2 = 60, W3 = 60
TL219	0.004 λ , 24.85 Ω	W1 = 3.048, W2 = 3.048, W3 = 0.762	W1 = 120, W2 = 120, W3 = 30
TL220		W1 = 1.087, W2 = 3.048	W1 = 43, W2 = 120
TL221	0.010 λ , 24.85 Ω	W = 3.048, L = 1.778	W = 120, L = 70
TL222	0.007 λ , 41.47 Ω	W = 1.524, L = 1.346	W = 60, L = 53
TL223	0.007 λ , 63.55 Ω	W = 0.762, L = 1.270	W = 30, L = 50
TL224	0.004 λ , 51.66 Ω	W = 1.087, L = 0.851	W = 43, L = 33

Reference Circuit, 940 MHz (cont.)

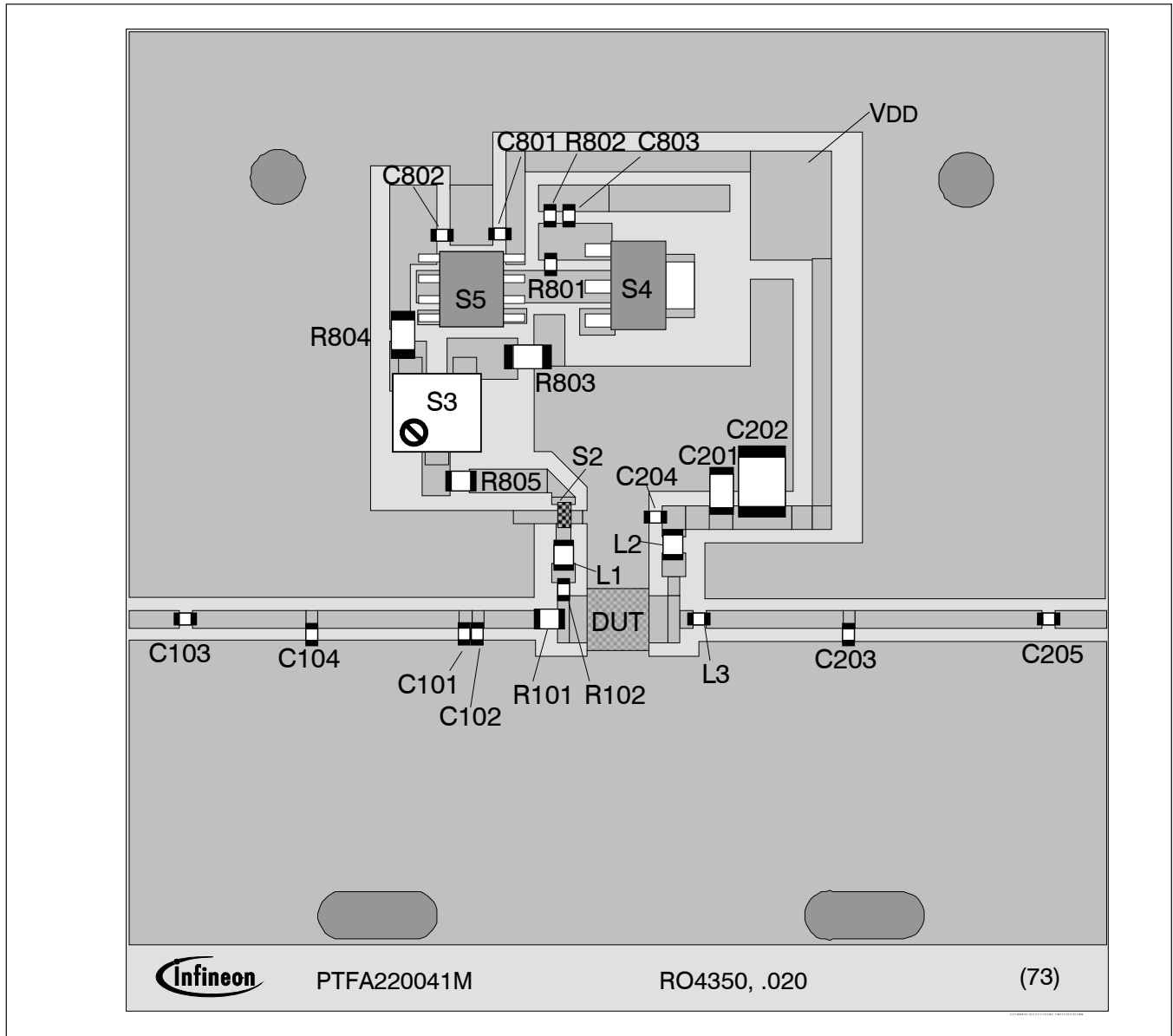

Reference circuit assembly diagram (not to scale)

Reference Circuit, 940 MHz (cont.)
Circuit Assembly Information

DUT	PTFA220041M	LDMOS Transistor	
PCB	LTN/PTFA220041M-9	0.508 mm [.020"] thick, $\epsilon_r = 3.48$	Rogers 4350, 1 oz. copper

Find Gerber files for this test fixture on the Infineon Web site at www.infineon.com/rfpower

Component	Description	Supplier	P/N
Input			
C101	Chip capacitor, 16 pF	ATC	100A160JW150X
C102	Chip capacitor, 22 pF	ATC	100A220JW150X
C103	Chip capacitor, 62 pF	ATC	100A620JW150X
C104	Chip capacitor, 10 pF	ATC	100A100JW150X
C801, C802, C803	Chip capacitor, 1000 pF	Digi-Key	PCC1772CT-ND
L1	Inductor, 22 nH	Coilcraft	0805HT-22NX_BG
R101	Resistor, 1.3 Ω	Digi-Key	P1.3ECT-ND
R102, R805	Resistor, 10 Ω	Digi-Key	P10ECT-ND
R801	Resistor, 1200 Ω	Digi-Key	P1.2KECT-ND
R802	Resistor, 1300 Ω	Digi-Key	P1.3KECT-ND
R803	Resistor, 500 Ω	Digi-Key	P5.0KECT-ND
R804	Resistor, 2000 Ω	Digi-Key	P2.0KECT-ND
S2	EMI Suppression Capacitor	Murata	NFM18PS105R0J3
S3	Potentiometer, 2k Ω	Digi-Key	3224W-202ECT-ND
S4	Transistor	Infineon Technologies	BCP56
S5	Voltage Regulator	National Semiconductor	LM7805
Output			
C201	Chip capacitor, 0.1 μ F	Digi-Key	PCC104BCT-ND
C202	Chip capacitor, 2.2 μ F	Digi-Key	445-1447-2-ND
C203	Chip capacitor, 3.6 pF	ATC	100A3R6CW150X
C204, C205	Chip capacitor, 62 pF	ATC	100A620JW150X
L2	Inductor, 22 nH	Coilcraft	0805HT-22NX_BG
L3	Inductor, 4.3 nH	Coilcraft	0603CS-4N3X_BG

Package Outline Specifications

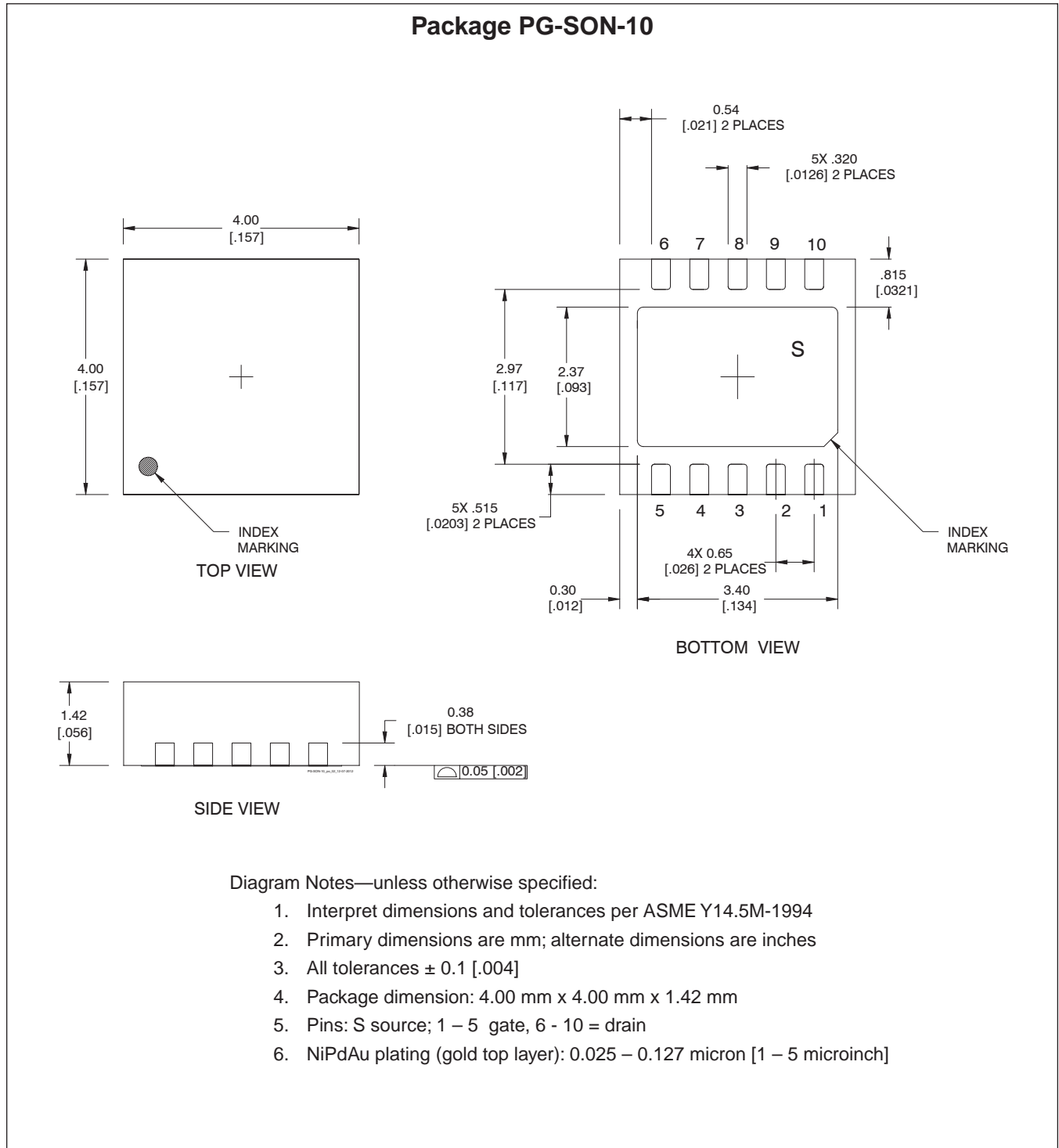

Find the latest and most complete information about products and packaging at the Infineon Internet page <http://www.infineon.com/rfpower>

Revision History

Revision	Date	Data Sheet	Page	Subjects (major changes at each revision)
01	2008-12-16	Advance	all	Advance Specifications for product in development.
02	2009-06-19	Advance	1, 2, 3	Refine RF characteristics. Add package information (still preliminary).
03	2009-08-03	Advance	1 – 3	Update package information.
04	2009-11-03	Production	all	Firm specifications for this released product, including reference circuit and complete package outline information.
05	2009-18-18	Production	11 – 16	Add 940 MHz performance and reference circuit information.
06	2010-01-19	Production	2	Review and update specifications.
07	2010-04-15	Production	2	Add moisture sensitivity table.
08	2010-06-07	Production	6	Revise broadband circuit impedance.
09	2011-04-01	Production	1 5, 12	Update ESD information Remove CW performance graphs
10	2016-03-17	Production	2	Add current shipping and ordering information. Operating gate voltage adjusted.
10.1	2016-06-01	Production	all 18	Add revision state to footer Correct product version to V4

We Listen to Your Comments

Any information within this document that you feel is wrong, unclear or missing at all? Your feedback will help us to continuously improve the quality of this document. Please send your proposal (including a reference to this document) to:

highpowerRF@infineon.com

To request other information, contact us at:
+1 877 465 3667 (1-877-GO-LDMOS) USA
or +1 408 776 0600 International

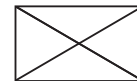

Edition 2016-06-01

Published by
Infineon Technologies AG
85579 Neubiberg, Germany

© 2009 – 2016 Infineon Technologies AG
All Rights Reserved.

Legal Disclaimer

The information given in this document shall in no event be regarded as a guarantee of conditions or characteristics. With respect to any examples or hints given herein, any typical values stated herein and/or any information regarding the application of the device, Infineon Technologies hereby disclaims any and all warranties and liabilities of any kind, including without limitation, warranties of non-infringement of intellectual property rights of any third party.

Information

For further information on technology, delivery terms and conditions and prices, please contact the nearest Infineon Technologies Office (www.infineon.com/rfpower).

Warnings

Due to technical requirements, components may contain dangerous substances. For information on the types in question, please contact the nearest Infineon Technologies Office.

Infineon Technologies components may be used in life-support devices or systems only with the express written approval of Infineon Technologies, if a failure of such components can reasonably be expected to cause the failure of that life-support device or system or to affect the safety or effectiveness of that device or system. Life support devices or systems are intended to be implanted in the human body or to support and/or maintain and sustain and/or protect human life. If they fail, it is reasonable to assume that the health of the user or other persons may be endangered.