

Thermally-Enhanced High Power RF LDMOS FETs 90 W, 28 V, 920 – 960 MHz

Description

The PTFB090901EA and PTFB090901FA are 90-watt LDMOS FETs intended for use in multi-standard cellular power amplifier applications in the 920 to 960 MHz frequency band. Features include input and output matching, high gain and thermally-enhanced packages. Manufactured with Infineon's advanced LDMOS process, these devices provide excellent thermal performance and superior reliability.

PTFB090901EA
Package H-36265-2

PTFB090901FA
Package H-37265-2

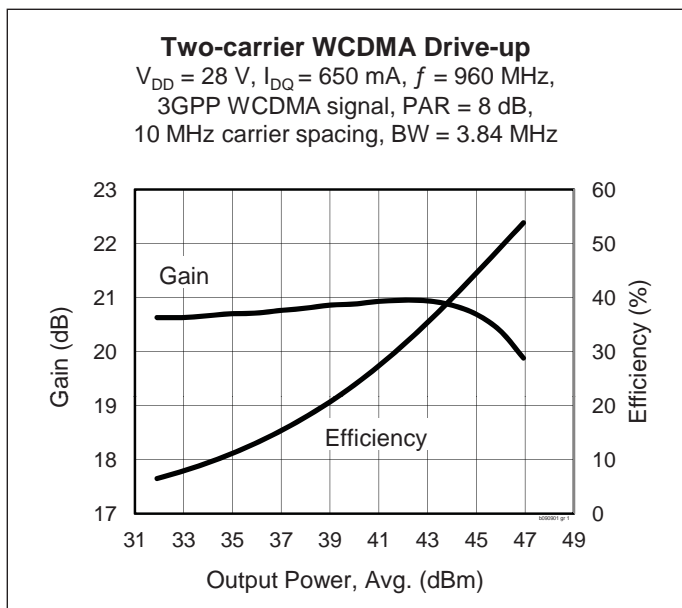
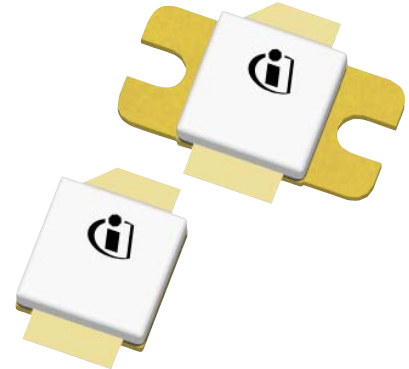

Features

- Input and output internal matching
- Typical CW performance, 960 MHz, 28 V
 - Output power at $P_{1dB} = 90\text{ W}$
 - Efficiency = 65%
- Typical two-carrier WCDMA performance, 960 MHz, 28 V
 - Average output power = 20 W
 - Linear Gain = 20.8 dB
 - Efficiency = 35%
 - Intermodulation distortion = -35 dBc
- Integrated ESD protection
- Low thermal resistance
- Pb-free and RoHS-compliant
- Capable of handling 10:1 VSWR @ 28 V, 90 W (CW) output power

RF Characteristics

Single-carrier WCDMA Specifications (tested in Infineon test fixture)

$V_{DD} = 28\text{ V}$, $I_{DQ} = 650\text{ mA}$, $P_{OUT} = 25\text{ W}$ average, $f = 960\text{ MHz}$
 3GPP signal, PAR = 10 dB @ 0.01% CCDF probability, channel bandwidth = 3.84 MHz

Characteristic	Symbol	Min	Typ	Max	Unit
Gain	G_{ps}	19	19.5	—	dB
Drain Efficiency	η_D	36	40	—	%
Adjacent Channel Power Ratio	ACPR	—	-35	-31.5	dBc

All published data at $T_{CASE} = 25^\circ\text{C}$ unless otherwise indicated

ESD: Electrostatic discharge sensitive device—observe handling precautions!

Target RF Characteristics (cont.)

Two-tone Specifications (not subject to production test—verified by design/characterization in Infineon test fixture)
 $V_{DD} = 28\text{ V}$, $I_{DQ} = 650\text{ mA}$, $P_{OUT} = 70\text{ W PEP}$, $f = 960\text{ MHz}$, tone spacing = 1 MHz

Characteristic	Symbol	Min	Typ	Max	Unit
Gain	G_{ps}	—	19.5	—	dB
Drain Efficiency	η_D	—	48	—	%
Intermodulation Distortion	IMD	—	-30	—	dBc

DC Characteristics

Characteristic	Conditions	Symbol	Min	Typ	Max	Unit
Drain-source Breakdown Voltage	$V_{GS} = 0\text{ V}$, $I_{DS} = 10\text{ mA}$	$V_{(BR)DSS}$	65	—	—	V
Drain Leakage Current	$V_{DS} = 28\text{ V}$, $V_{GS} = 0\text{ V}$	I_{DSS}	—	—	1.0	μA
	$V_{DS} = 63\text{ V}$, $V_{GS} = 0\text{ V}$	I_{DSS}	—	—	10.0	μA
On-state Resistance	$V_{GS} = 10\text{ V}$, $V_{DS} = 0.1\text{ V}$	$R_{DS(on)}$	—	0.123	—	Ω
Operating Gate Voltage	$V_{DS} = 28\text{ V}$, $I_{DQ} = 650\text{ mA}$	V_{GS}	—	3.8	—	V
Gate Leakage Current	$V_{GS} = 10\text{ V}$, $V_{DS} = 0\text{ V}$	I_{GSS}	—	—	1.0	μA

Maximum Ratings

Parameter	Symbol	Value	Unit
Drain-source Voltage	V_{DSS}	65	V
Gate-source Voltage	V_{GS}	-6 to +10	V
Junction Temperature	T_J	200	$^{\circ}\text{C}$
Storage Temperature Range	T_{STG}	-40 to +150	$^{\circ}\text{C}$
Thermal Resistance ($T_{CASE} = 70^{\circ}\text{C}$, 85 W CW)	$R_{\theta JC}$	0.73	$^{\circ}\text{C/W}$

Ordering Information

Type and Version	Order Code	Package	Package Description	Shipping
PTFB090901EA V1	PTFB090901EAV1XWSA1	H-36265-2	Ceramic open-cavity, bolt-down	Tray
PTFB090901EA V1 R250	PTFB090901EAV1R250XTMA1	H-36265-2	Ceramic open-cavity, bolt-down	Tape & Reel, 250 pcs
PTFB090901FA V1	PTFB090901FAV1XWSA1	H-37265-2	Ceramic open-cavity, earless	Tray
PTFB090901FA V1 R250	PTFB090901FAV1R250XTMA1	H-37265-6/2	Ceramic open-cavity, earless	Tape & Reel, 250 pcs

Typical Performance (data taken in a production test fixture)

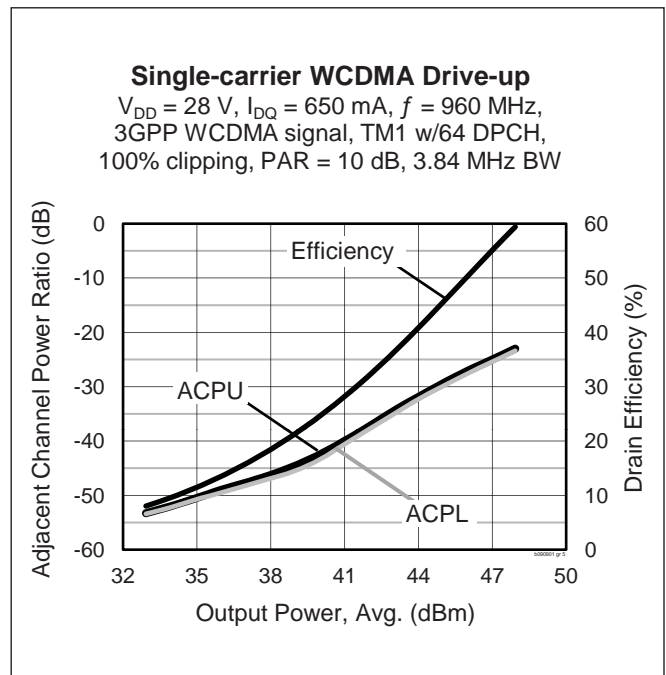
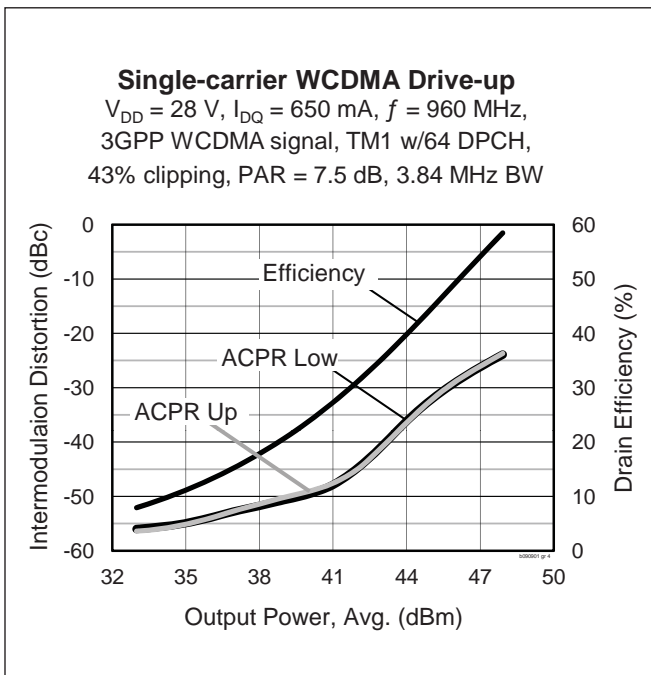
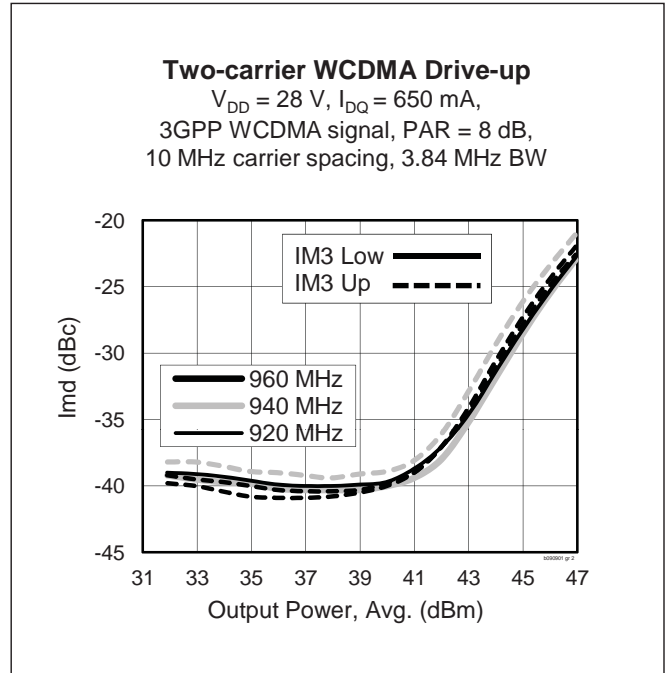
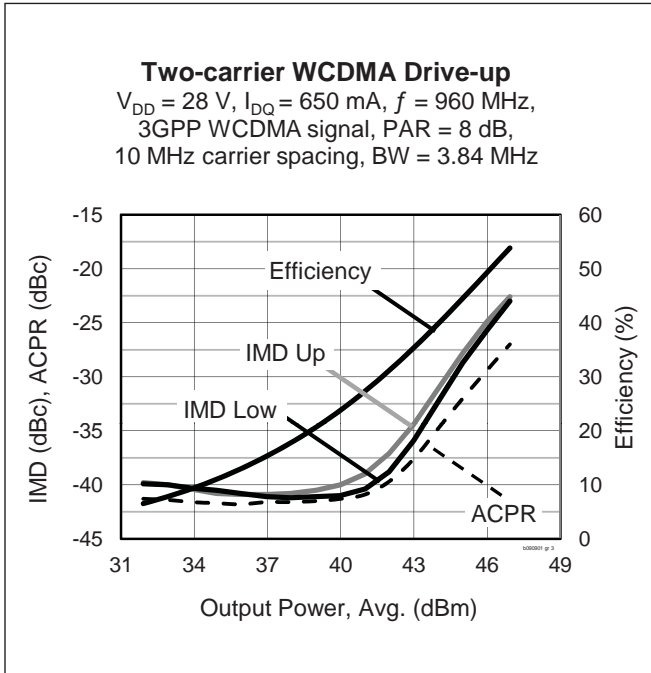

Typical Performance (cont.)

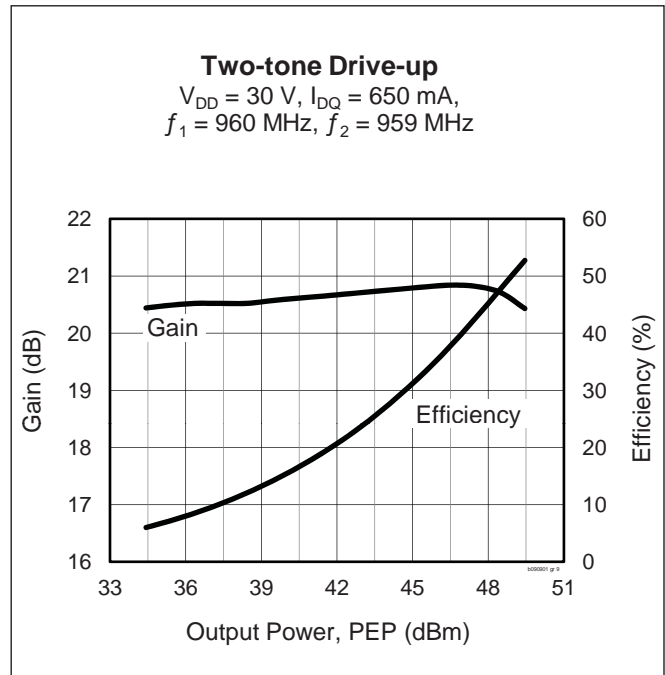
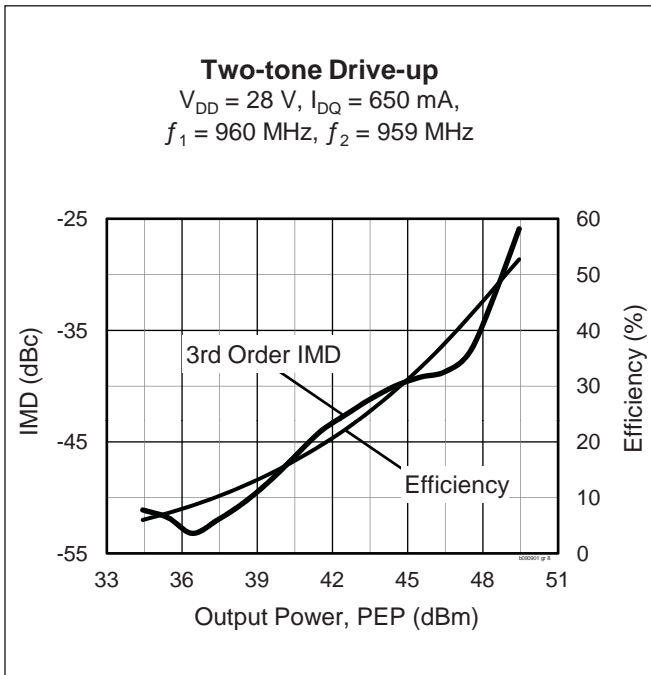
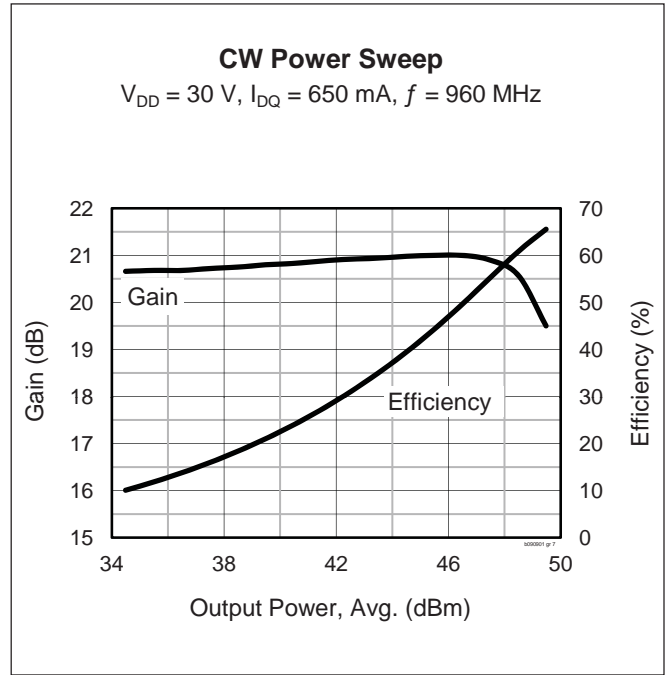
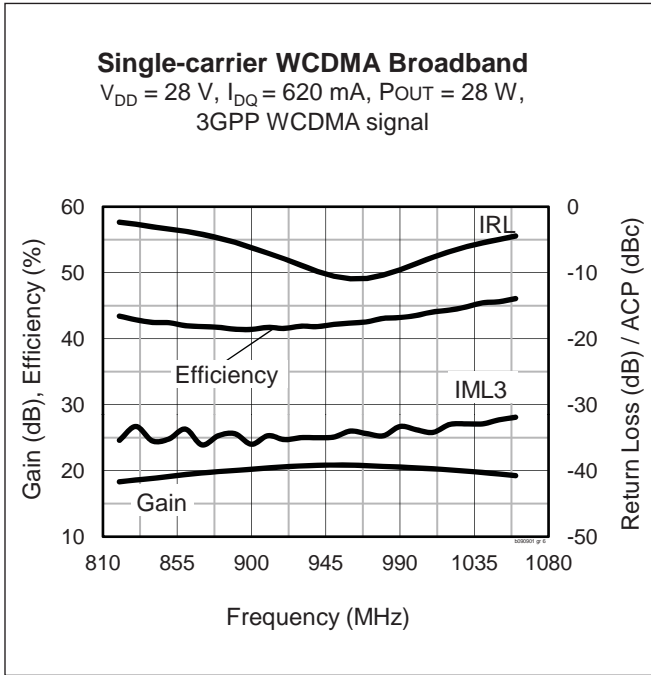

Typical Performance (cont.)

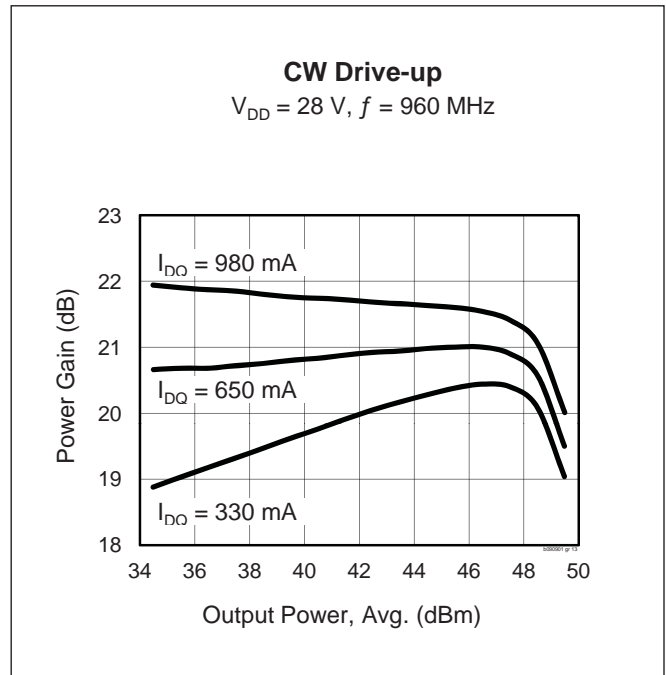
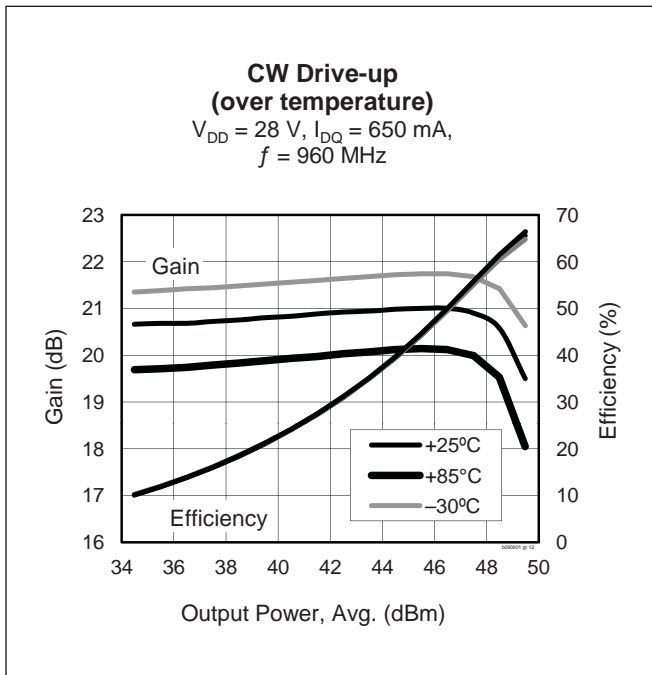
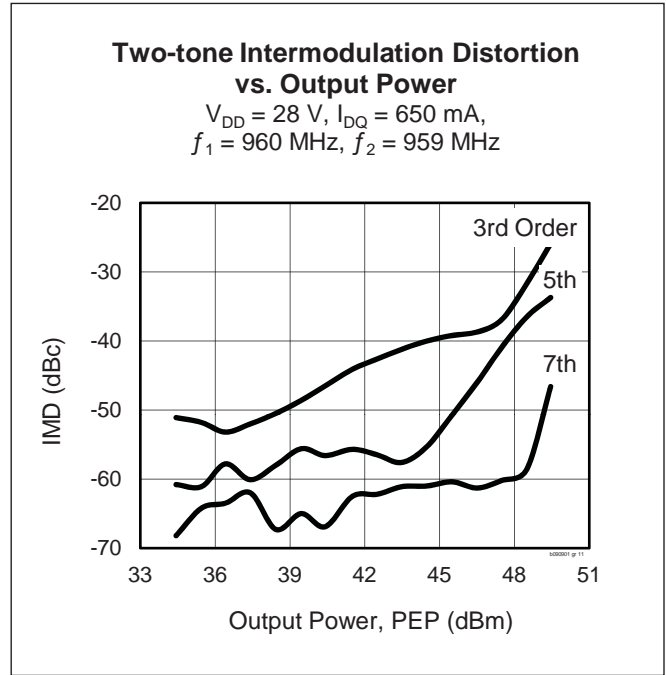
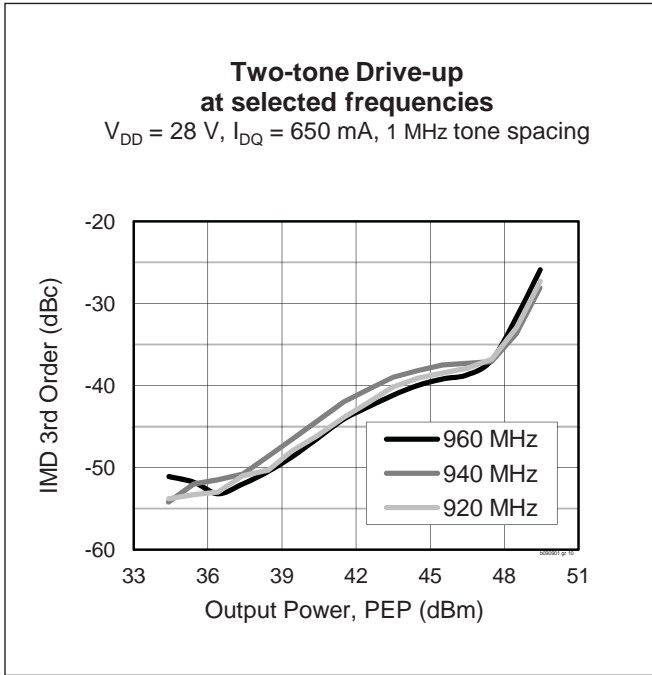

Broadband Circuit Impedance

Frequency MHz	Z Source Ω		Z Load Ω	
	R	jX	R	jX
900	2.3	-6.4	3.8	-2.6
920	2.2	-6.2	3.6	-2.3
940	2.1	-6.0	3.5	-2.1
960	1.9	-5.8	3.4	-1.8
980	1.8	-5.6	3.3	-1.6

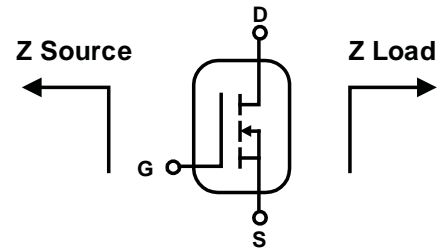

See next page for reference circuit information

Reference Circuit

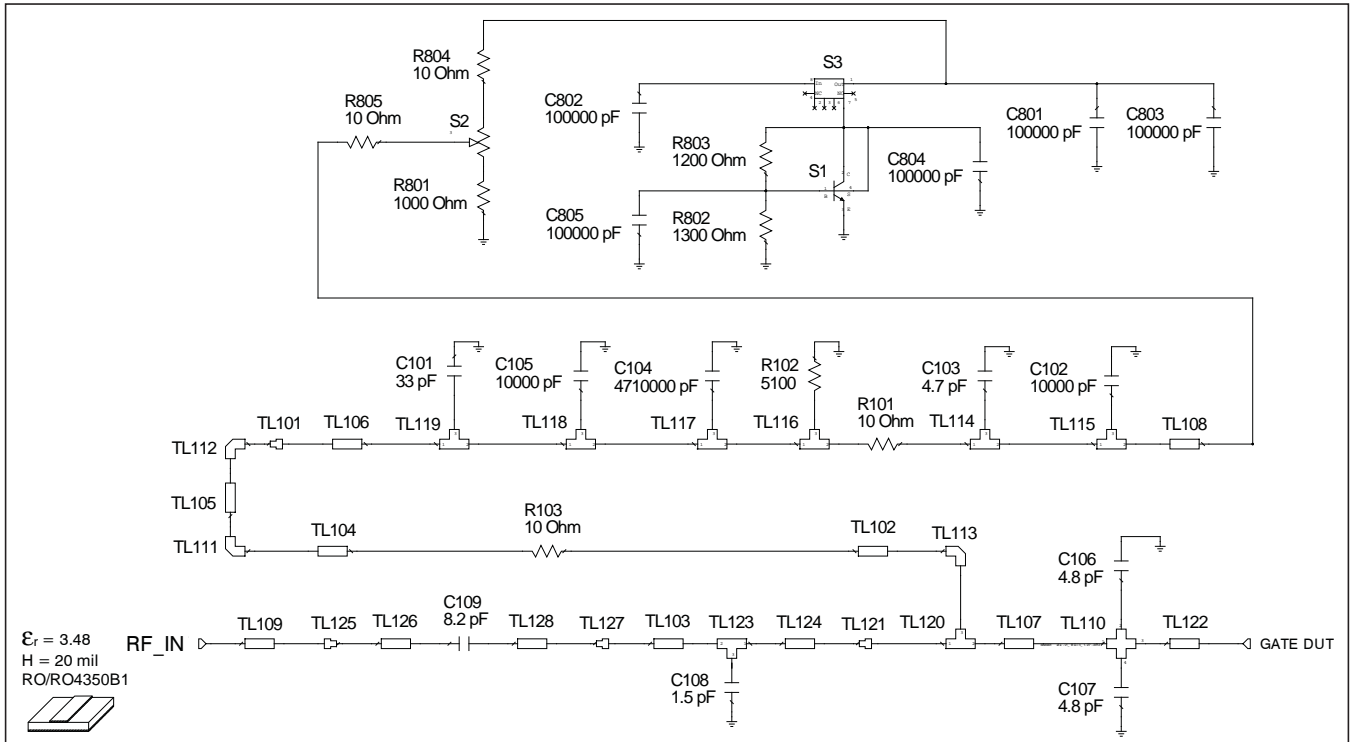

Reference circuit input schematic for $f = 960$ MHz

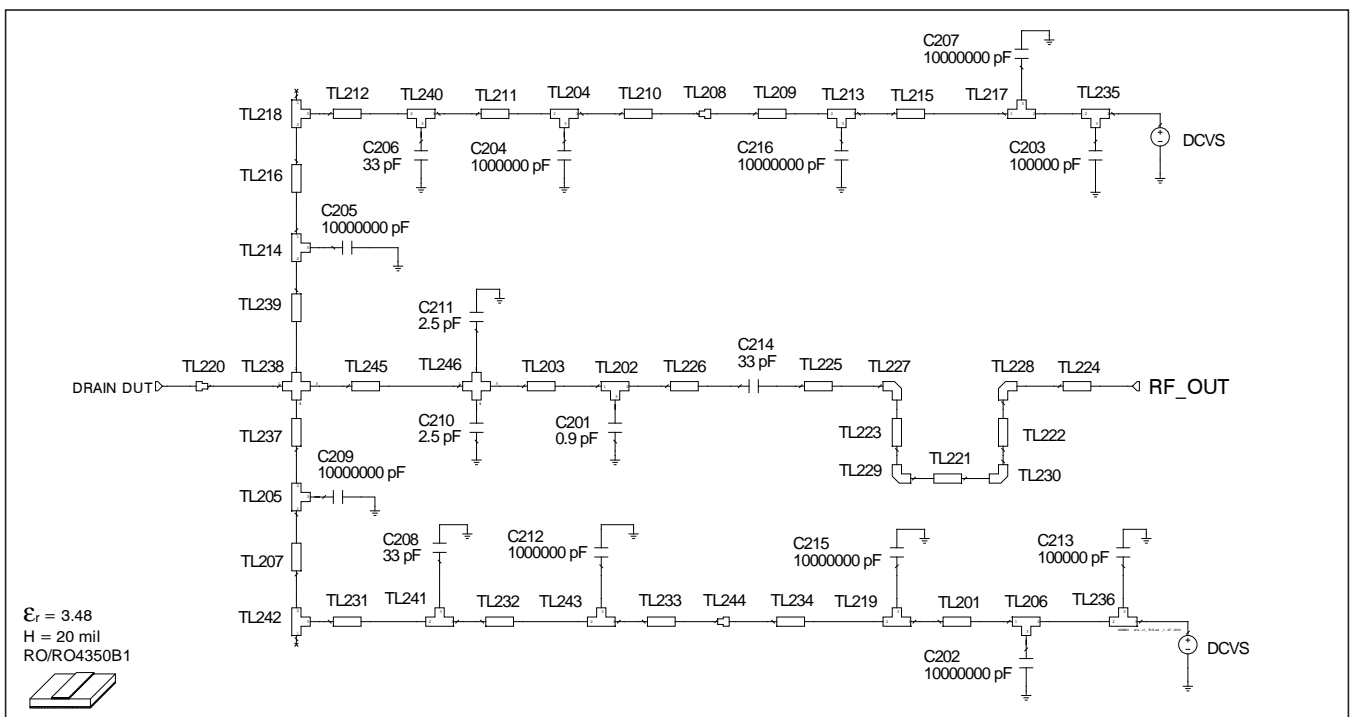

Reference circuit input schematic for $f = 960$ MHz

Reference Circuit (cont.)

Reference Circuit Assembly

DUT	PTFB090901EA or PTFB090901FA		
Test Fixture Part No.	LTN/PTFB090901EA (PTFB090901EA)	LTN/PTFB090901FA (PTFB090901FA)	
PCB	Rogers RO4350, 0.508 mm [0.020"] thick, 2 oz. copper, $\epsilon_r = 3.48$		
Find Gerber files for this test fixture on the Infineon Web site at http://www.infineon.com/rfpower			

Electrical Characteristics at 960 MHz

Transmission Line	Electrical Characteristics	Dimensions: mm	Dimensions: mils
Input			
TL102	0.0064 λ , 69.6 Ω	W = 0.65, L = 1.23	W = 25, L = 48
TL103	0.1238 λ , 51.53 Ω	W = 1.1, L = 23.38	W = 43, L = 921
TL104	0.1658 λ , 69.6 Ω	W = 0.65, L = 31.91	W = 25, L = 1256
TL105	0.0205 λ , 69.6 Ω	W = 0.65, L = 3.94	W = 25, L = 155
TL106	0.0014 λ , 26.81 Ω	W = 2.79, L = 0.25	W = 110, L = 10
TL107	0.0195 λ , 7.47 Ω	W = 12.37, L = 3.37	W = 487, L = 133
TL108	0.0014 λ , 26.81 Ω	W = 2.79, L = 0.25	W = 110, L = 10
TL109	0.0369 λ , 51.53 Ω	W = 1.1, L = 6.97	W = 43, L = 275
TL114, TL115, TL116, TL117, TL118, TL119	0.014 λ , 26.81 Ω	W1 = 2.79, W2 = 2.79, W3 = 2.54	W1 = 110, W2 = 110, W3 = 100
TL120	0.0037 λ , 7.47 Ω	W1 = 12.37, W2 = 12.37, W3 = 0.65	W1 = 487, W2 = 487, W3 = 25
TL122	0.0294 λ , 7.47 Ω	W = 12.37, L = 5.08	W = 487, L = 200
TL123	0.0094 λ , 51.53 Ω	W1 = 1.1, W2 = 1.1, W3 = 1.78	W1 = 43, W2 = 43, W3 = 70
TL124	0.0183 λ , 51.53 Ω	W = 1.1, L = 3.45	W = 43, L = 136
TL126, TL128	0.0055 λ , 34.08 Ω	W = 2.03, L = 1.02	W = 80, L = 40

Reference Circuit (cont.)

Electrical Characteristics at 960 MHz (cont.)

Transmission Line	Electrical Characteristics	Dimensions: mm	Dimensions: mils
Output			
TL201	0.055 λ , 9.74 Ω	W = 9.25, L = 9.65	W = 364, L = 380
TL202	0.010 λ , 11.08 Ω	W1 = 8, W2 = 8, W3 = 1.78	W1 = 315, W2 = 315, W3 = 70
TL203	0.081 λ , 11.08 Ω	W = 8, L = 14.2	W = 315, L = 559
TL204, TL243	0.008 λ , 47.12 Ω	W1 = 1.27, W2 = 1.27, W3 = 1.52	W1 = 50, W2 = 50, W3 = 60
TL205, TL214	0.011 λ , 47.12 Ω	W1 = 1.27, W2 = 1.27, W3 = 2.03	W1 = 50, W2 = 50, W3 = 80
TL206, TL213, TL217, TL219	0.009 λ , 9.74 Ω	W1 = 9.25, W2 = 9.25, W3 = 1.52	W1 = 364, W2 = 364, W3 = 60
TL207	0.007 λ , 47.12 Ω	W = 1.27, L = 1.4	W = 50, L = 55
TL209	0.030 λ , 9.74 Ω	W = 9.25, L = 5.21	W = 364, L = 205
TL210	0.075 λ , 47.12 Ω	W = 1.27, L = 14.05	W = 50, L = 553
TL211, TL232	0.002 λ , 47.12 Ω	W = 1.27, L = 0.38	W = 50, L = 15
TL212	0.060 λ , 47.12 Ω	W = 1.27, L = 11.2	W = 50, L = 441
TL215	0.055 λ , 9.74 Ω	W = 9.25, L = 9.65	W = 364, L = 380
TL216	0.007 λ , 47.12 Ω	W = 1.27, L = 1.4	W = 50, L = 55
TL218	0.007 λ , 47.12 Ω	W1 = 1.27, W2 = 1.27, W3 = 1.27	W1 = 50, W2 = 50, W3 = 50
TL221	0.006 λ , 38.69 Ω	W = 1.7, L = 1.14	W = 67, L = 45
TL222, TL223	0.061 λ , 38.69 Ω	W = 1.7, L = 11.3	W = 67, L = 445
TL224	0.030 λ , 51.46 Ω	W = 1.1, L = 5.69	W = 43, L = 224
TL225	0.012 λ , 38.69 Ω	W = 1.7, L = 2.22	W = 67, L = 87
TL226	0.073 λ , 11.08 Ω	W = 8, L = 12.7	W = 315, L = 500
TL231	0.060 λ , 47.12 Ω	W = 1.27, L = 11.2	W = 50, L = 441
TL233	0.075 λ , 47.12 Ω	W = 1.27, L = 14.05	W = 50, L = 553
TL234	0.030 λ , 9.74 Ω	W = 9.25, L = 5.21	W = 364, L = 205
TL235, TL236	0.014 λ , 9.74 Ω	W1 = 9.25, W2 = 9.25, W3 = 2.36	W1 = 364, W2 = 364, W3 = 93
TL237, TL239	0.082 λ , 47.12 Ω	W = 1.27, L = 15.35	W = 50, L = 604
TL240, TL241	0.009 λ , 47.12 Ω	W1 = 1.27, W2 = 1.27, W3 = 1.78	W1 = 50, W2 = 50, W3 = 70
TL242	0.007 λ , 47.12 Ω	W1 = 1.27, W2 = 1.27, W3 = 1.27	W1 = 50, W2 = 50, W3 = 50
TL245	0.017 λ , 11.08 Ω	W = 8, L = 2.92	W = 315, L = 115

Reference Circuit (cont.)

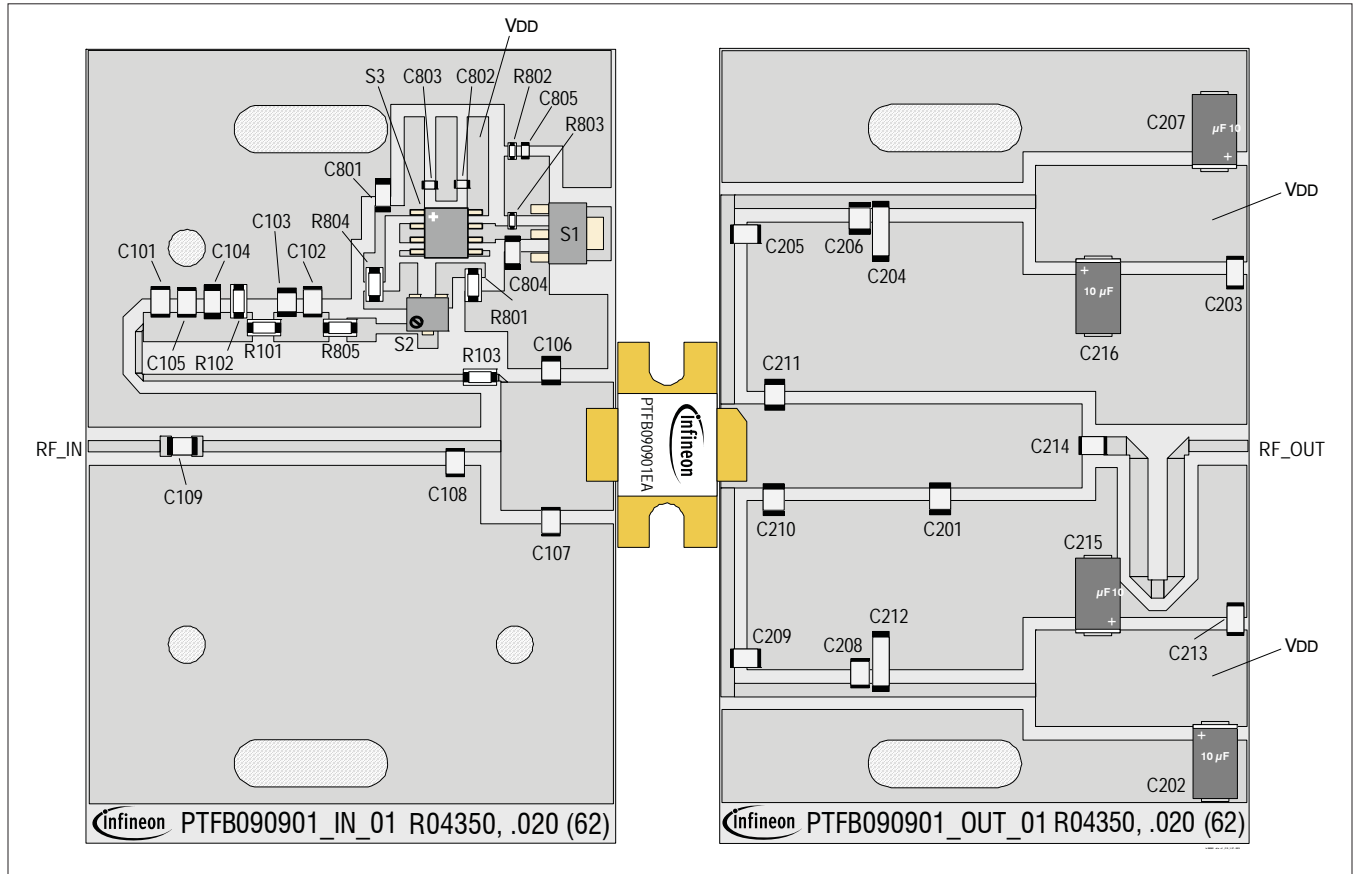

Reference circuit assembly diagram (not to scale)

Component ID	Description	Suggested Supplier	P/N
Input			
C101	Chip capacitor, 33 pF	ATC	100B330FW500XB
C102	Chip capacitor, 10000 pF	ATC	200B103MW
C103	Chip capacitor, 4.7 pF	ATC	100B4R7BW500XB
C104	Chip capacitor, 4.7 µF	Digi-Key	493-2372-2-ND
C105	Chip capacitor, 10000 pF	ATC	200B103MW
C106, C107	Chip capacitor, 4.8 pF	ATC	100B4R8BW500XB
C108	Chip capacitor, 1.5 pF	ATC	100B1R5BW500XB
C109	Chip capacitor, 8.2 pF	ATC	100B8R2BW500XB
C801, C804	Chip capacitor, 0.1 µF	Digi-Key	PCC104BCT-ND
C802, C803, C805	Chip capacitor, 1,000 pF	Digi-Key	PCC1772CT-ND
R801	Resistor, 1.0k Ω	Digi-Key	P1.0KECT-ND
R802	Resistor, 1.3k Ω	Digi-Key	P1.3KECT-ND
R803	Resistor, 1.2k Ω	Digi-Key	P1.2KECT-ND
R804, R805	Resistor, 10 Ω	Digi-Key	P10ECT-ND

table cont. next page

Reference Circuit (cont.)

Component ID	Description	Suggested Supplier	P/N
Input (cont.)			
S1	Transistor	Digi-Key	BCP5616TA-ND
S2	Potentiometer, 2k Ω	Digi-Key	3224W-202ECT-ND
S3	Voltage Regulator	Digi-Key	LM78L05ACM-ND
Output			
C201	Chip capacitor, 1 pF	ATC	100B0R9BW500XB
C202, C207, C215, C216	Chip capacitor, 1.0 μ F	ATC	281M5002106K
C203	Chip capacitor, 100000 pF	Digi-Key	PCC104BCT-ND
C204	Chip capacitor, 1000000 pF	Digi-Key	478-3993-2-ND
C205, C209	Capacitor, 10 μ F	Digi-Key	587-1818-2-ND
C206, C208	Chip capacitor, 33 pF	ATC	100B330JW500XB
C210, C211	Chip capacitor, 3 pF	ATC	100B2R5BW500XB
C212	Chip capacitor, 1000000 pF	Digi-Key	478-3993-2-ND
C213	Chip capacitor, 100000 pF	Digi-Key	PCC104BCT-ND
C214	Chip capacitor, 33 pF	ATC	100B330FW500XB

See next page for package outline

Package Outline Specifications

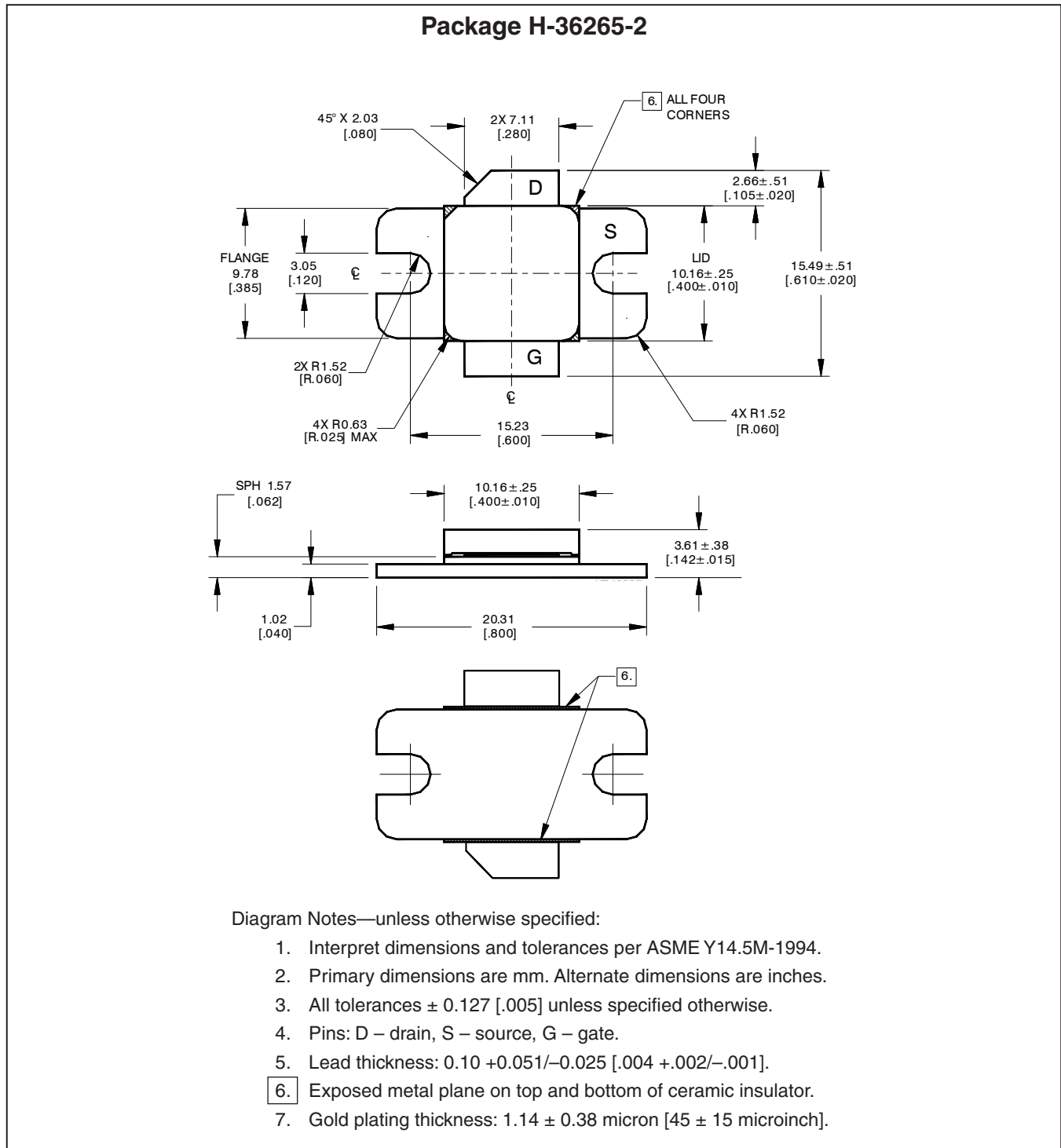

Package Outline Specifications (cont.)

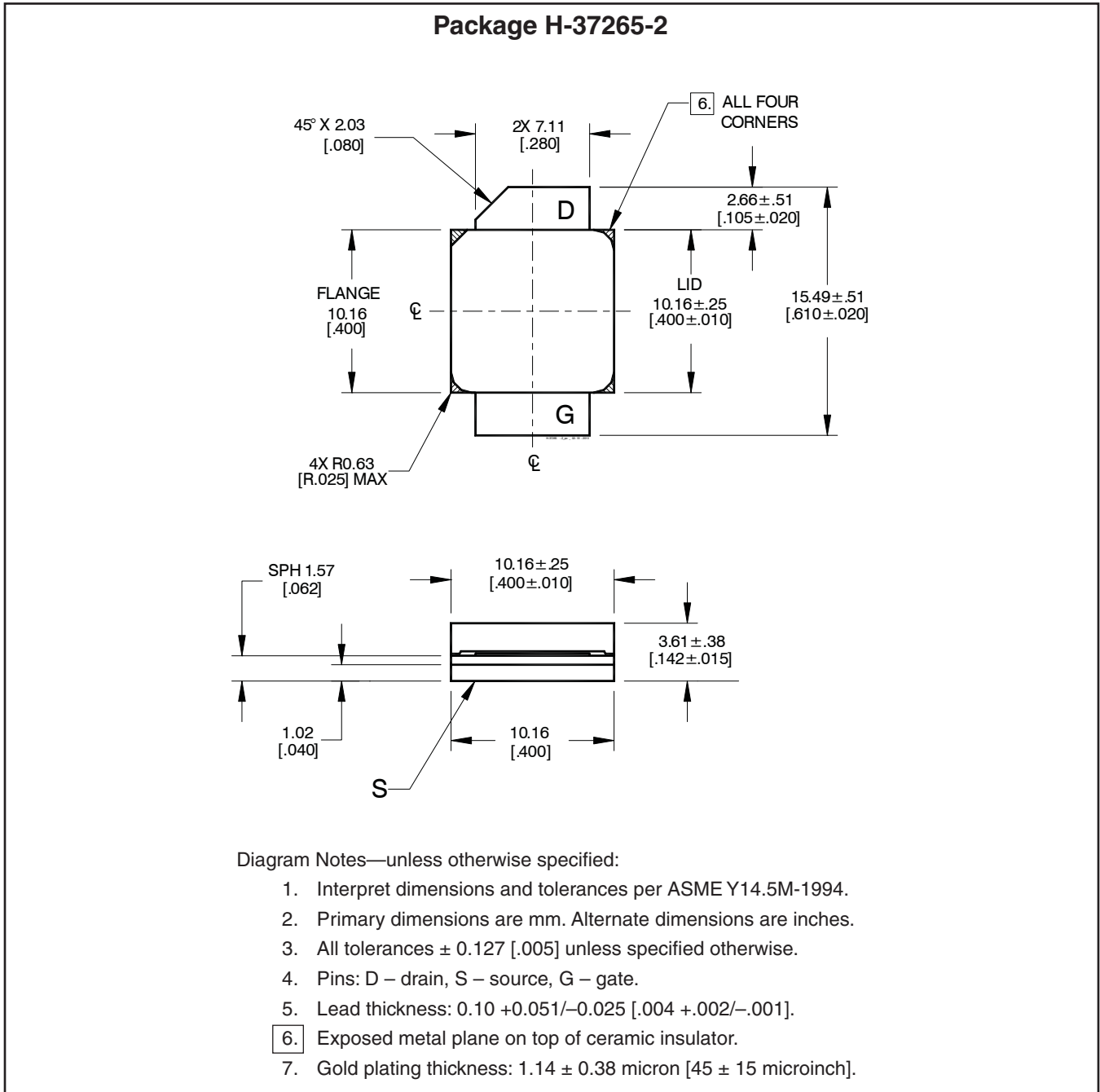

Find the latest and most complete information about products and packaging at the Infineon Internet page
<http://www.infineon.com/rfpower>

Revision History: 2012-02-23

Data Sheet

Previous Version: 2010-11-05, Advance Specification

Page	Subjects (major changes since last revision)
all	Products released to production: specifications finalized, circuit information added.

We Listen to Your Comments

Any information within this document that you feel is wrong, unclear or missing at all?
Your feedback will help us to continuously improve the quality of this document.
Please send your proposal (including a reference to this document) to:

highpowerRF@infineon.com

To request other information, contact us at:
+1 877 465 3667 (1-877-GO-LDMOS) USA
or +1 408 776 0600 International

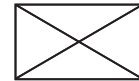

Edition 2012-02-23

**Published by
Infineon Technologies AG
81726 Munich, Germany**

**© 2010 Infineon Technologies AG
All Rights Reserved.**

Legal Disclaimer

The information given in this document shall in no event be regarded as a guarantee of conditions or characteristics. With respect to any examples or hints given herein, any typical values stated herein and/or any information regarding the application of the device, Infineon Technologies hereby disclaims any and all warranties and liabilities of any kind, including without limitation, warranties of non-infringement of intellectual property rights of any third party.

Information

For further information on technology, delivery terms and conditions and prices, please contact the nearest Infineon Technologies Office (www.infineon.com/rfpower).

Warnings

Due to technical requirements, components may contain dangerous substances. For information on the types in question, please contact the nearest Infineon Technologies Office.

Infineon Technologies components may be used in life-support devices or systems only with the express written approval of Infineon Technologies, if a failure of such components can reasonably be expected to cause the failure of that life-support device or system or to affect the safety or effectiveness of that device or system. Life support devices or systems are intended to be implanted in the human body or to support and/or maintain and sustain and/or protect human life. If they fail, it is reasonable to assume that the health of the user or other persons may be endangered.