

# PTFB201402FC

## High Power RF LDMOS Field Effect Transistor 140 W, 28 V, 2010 – 2025 MHz

### Description

The PTFB201402FC integrates two 70 W LDMOS FETs into one open-cavity ceramic package. It is designed primarily for Doherty cellular amplifier applications in the 2010 to 2025 MHz frequency band. Manufactured with Wolfspeed’s advanced LDMOS process, this device offers excellent thermal performance and superior reliability.

PTFB201402FC  
Package H-37248-4

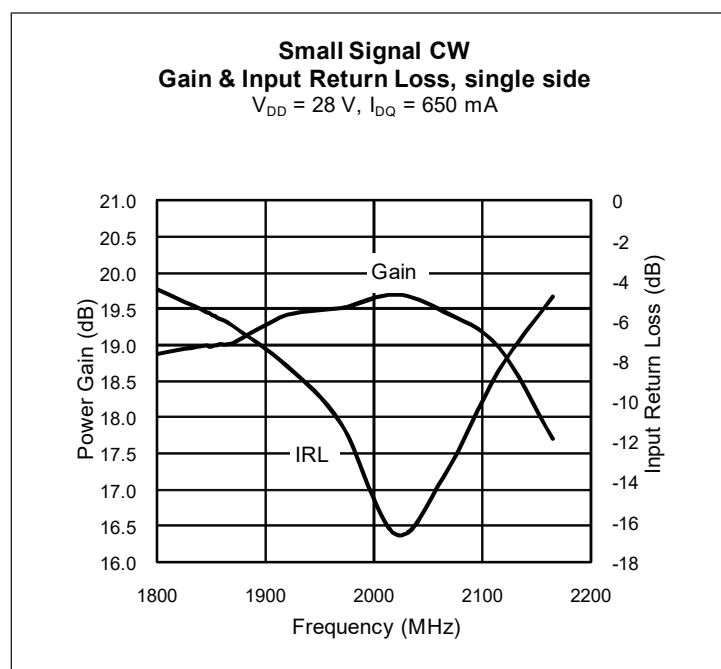

### Features

- Broadband internal matching
- Typical CW performance, 28 V, single side
  - Output power,  $P_{1dB} = 70\text{ W}$
  - Efficiency = 56%
- Integrated ESD protection
- Excellent thermal stability
- Capable of handling 10:1 VSWR @ 28 V, 70 W (CW) output power, per side
- Pb-free and RoHS-compliant

### RF Characteristics

#### Single-carrier WCDMA Specifications (tested in Wolfspeed Doherty test fixture)

$V_{DD} = 28\text{ V}, I_{DQ}(\text{main}) = 500\text{ mA}, V_{GSPK} = 42.6\% \times V_{GS1}, f_1 = 1880\text{ MHz}, f_2 = 2025\text{ MHz}, P_{OUT} = 20\text{ W}, \text{PAR} = 10\text{ dB @ } 0.01\% \text{ CCDF probability}$

Characteristic	Symbol	Min	Typ	Max	Unit
Gain	$G_{ps}$	15	16	—	dB
Drain Efficiency	$\eta_D$	34	36	—	%
Adjacent Channel Power Ratio	ACPR	—	-38.5	-33	dBc

All published data at  $T_{CASE} = 25^\circ\text{C}$  unless otherwise indicated

ESD: Electrostatic discharge sensitive device—observe handling precautions!

**DC Characteristics** (single side)

Characteristic	Conditions	Symbol	Min	Typ	Max	Unit
Drain-Source Breakdown Voltage	$V_{GS} = 0\text{ V}, I_{DS} = 10\text{ mA}$	$V_{(BR)DSS}$	65	—	—	V
Drain Leakage Current	$V_{DS} = 28\text{ V}, V_{GS} = 0\text{ V}$	$I_{DSS}$	—	—	1.0	$\mu\text{A}$
Drain Leakage Current	$V_{DS} = 63\text{ V}, V_{GS} = 0\text{ V}$	$I_{DSS}$	—	—	10.0	$\mu\text{A}$
On-State Resistance	$V_{GS} = 10\text{ V}, V_{DS} = 0.1\text{ A}$	$R_{DS(on)}$	—	0.3	—	$\Omega$
Operating Gate Voltage	$V_{DS} = 28\text{ V}, I_{DQ} = 650\text{ mA}$	$V_{GS}$	2.3	2.8	3.3	V
Gate Leakage Current	$V_{GS} = 10\text{ V}, V_{DS} = 0\text{ V}$	$I_{GSS}$	—	—	1.0	$\mu\text{A}$

**Maximum Ratings**

Parameter	Symbol	Value	Unit
Drain-Source Voltage	$V_{DSS}$	65	V
Gate-Source Voltage	$V_{GS}$	-6 to +10	V
Junction Temperature	$T_J$	200	$^{\circ}\text{C}$
Storage Temperature Range	$T_{STG}$	-40 to +150	$^{\circ}\text{C}$
Thermal Resistance ( $T_{CASE} = 70^{\circ}\text{C}, 120\text{ W CW}$ )	$R_{\theta JC}$	0.39	$^{\circ}\text{C/W}$

**Ordering Information**

Type and Version	Order Code	Package Description	Shipping
PTFB201402FC V1 R0	PTFB201402FC-V1-R0	H-37248-4, earless flange	Tape & Reel, 50 pcs
PTFB201402FC V1 R250	PTFB201402FC-V1-R250	H-37248-4, earless flange	Tape & Reel, 250 pcs



**Typical Performance** (data taken in a production test fixture)

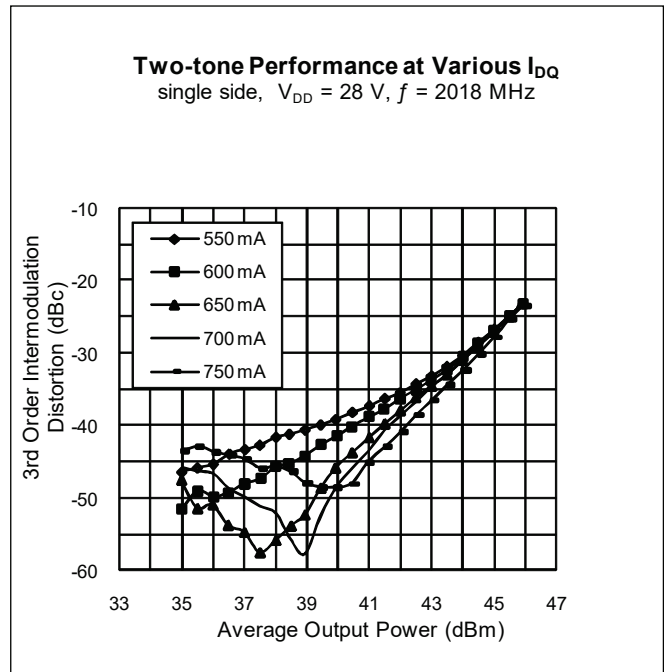
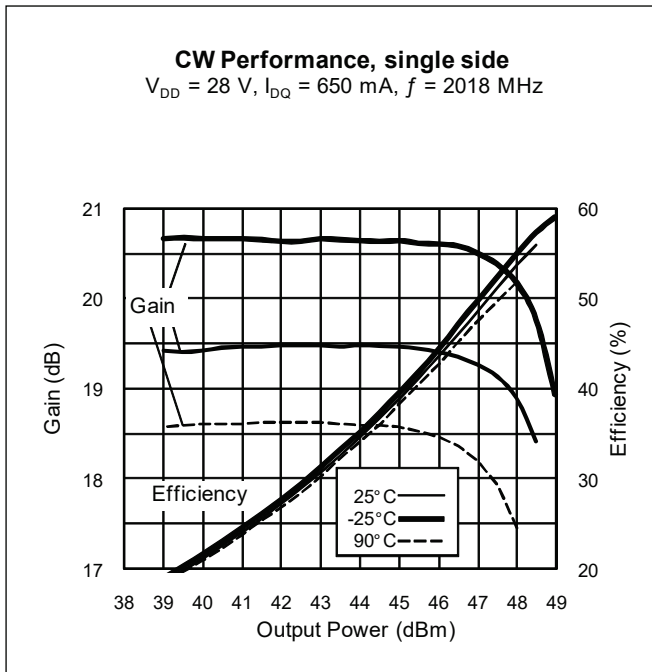
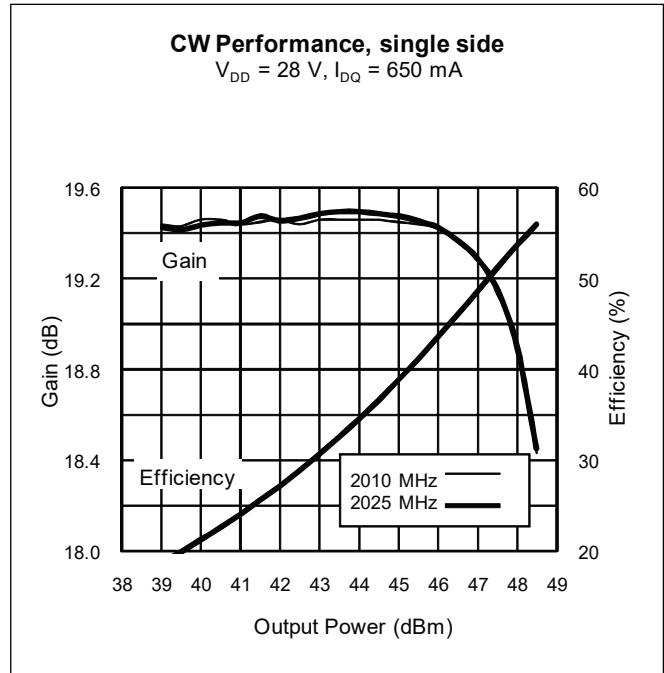
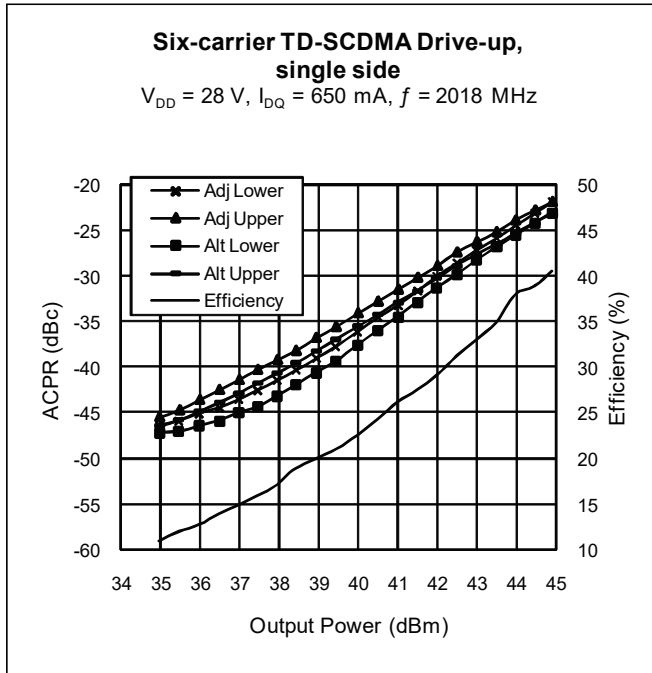



**Typical Performance** (cont.)

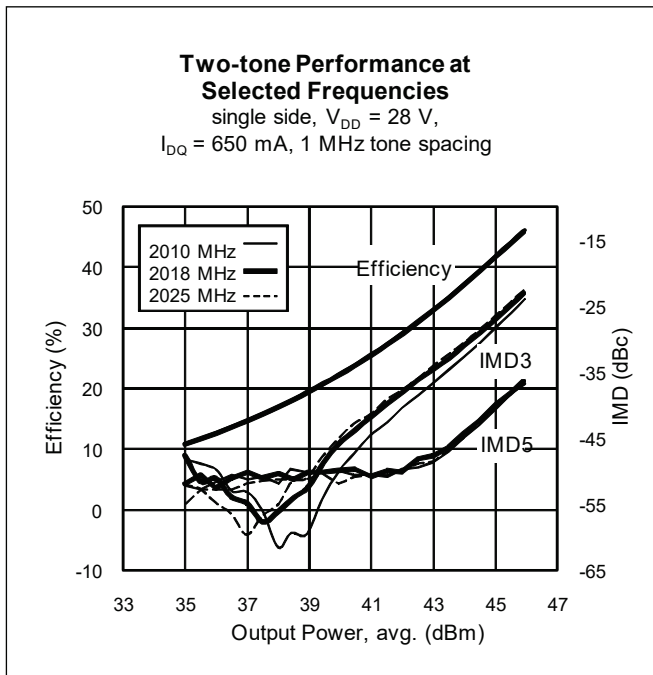
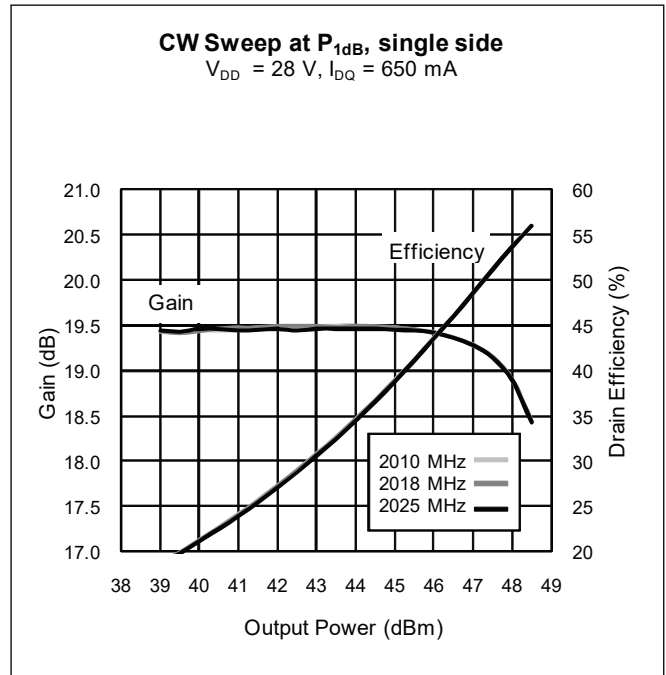
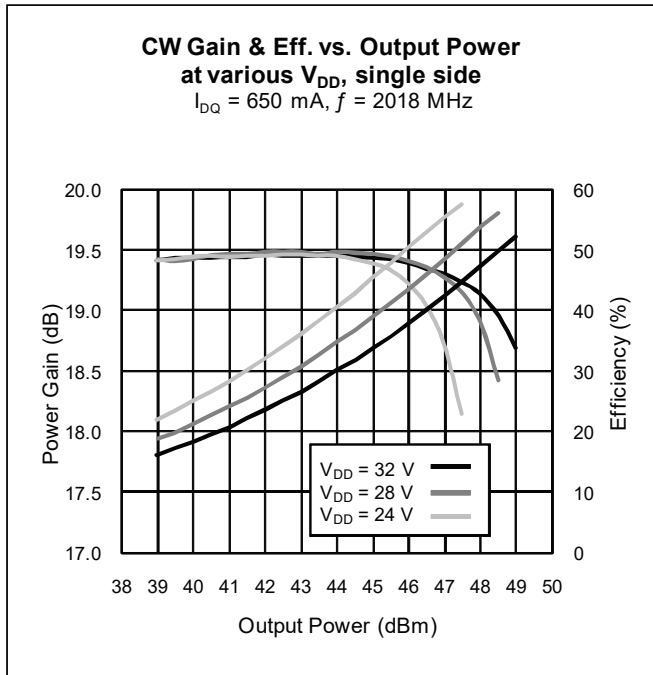

### Broadband Circuit Impedance

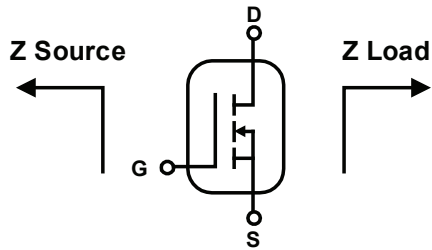

Frequency MHz	Z Source $\Omega$		Z Load $\Omega$	
	R	jX	R	jX
2010	15.4	3.8	3.9	-4.4
2025	15.5	4.1	3.9	-4.4

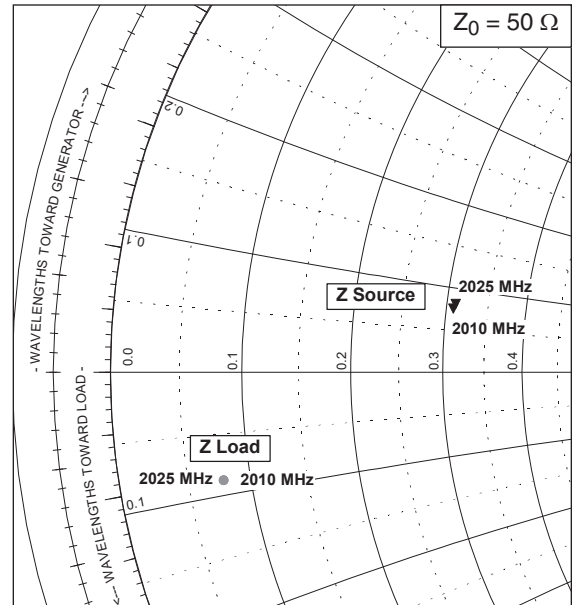

See next page for reference circuit information

Reference Circuit

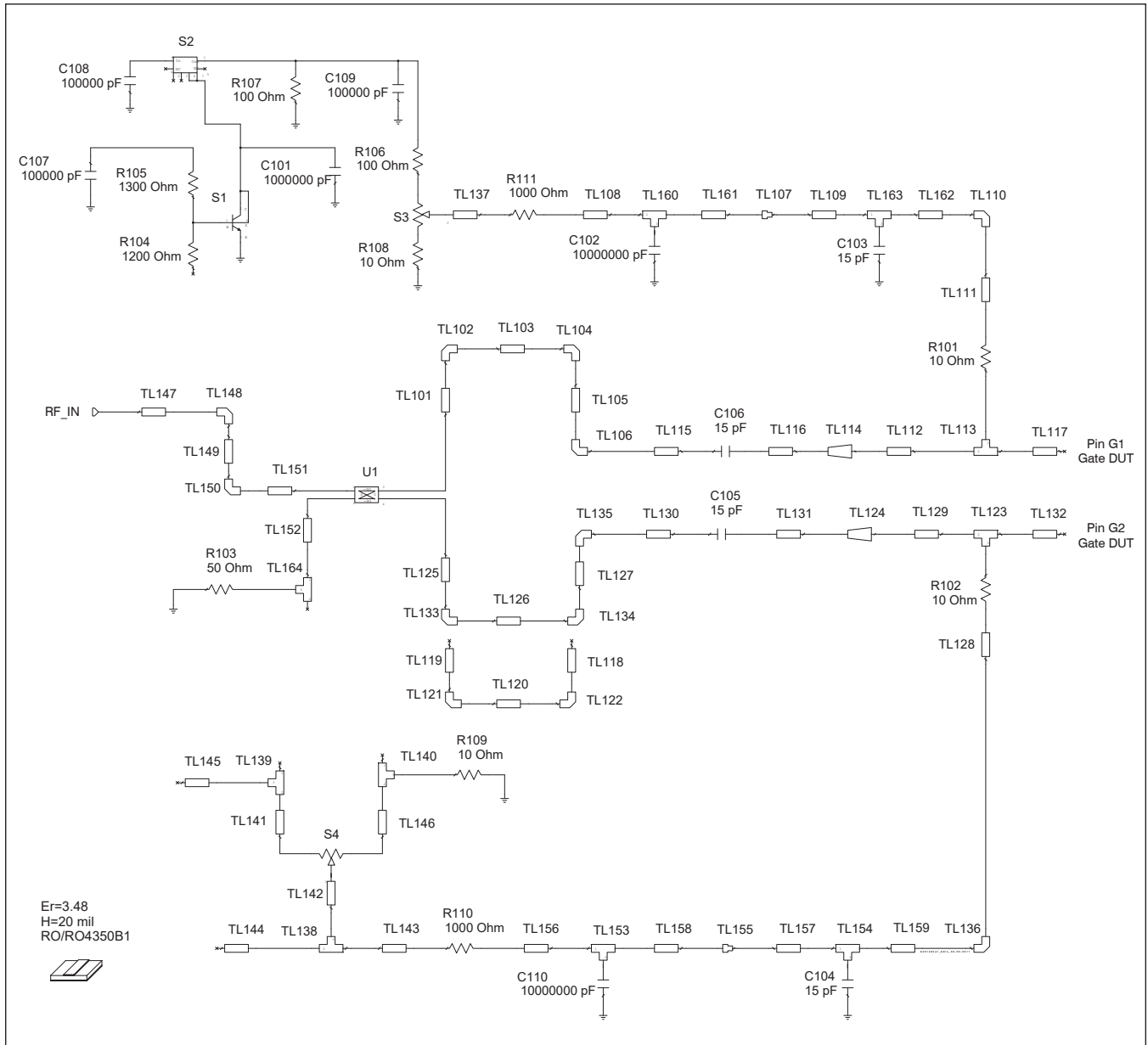

Reference circuit input schematic for  $f = 2170$  MHz

Reference Circuit (cont.)

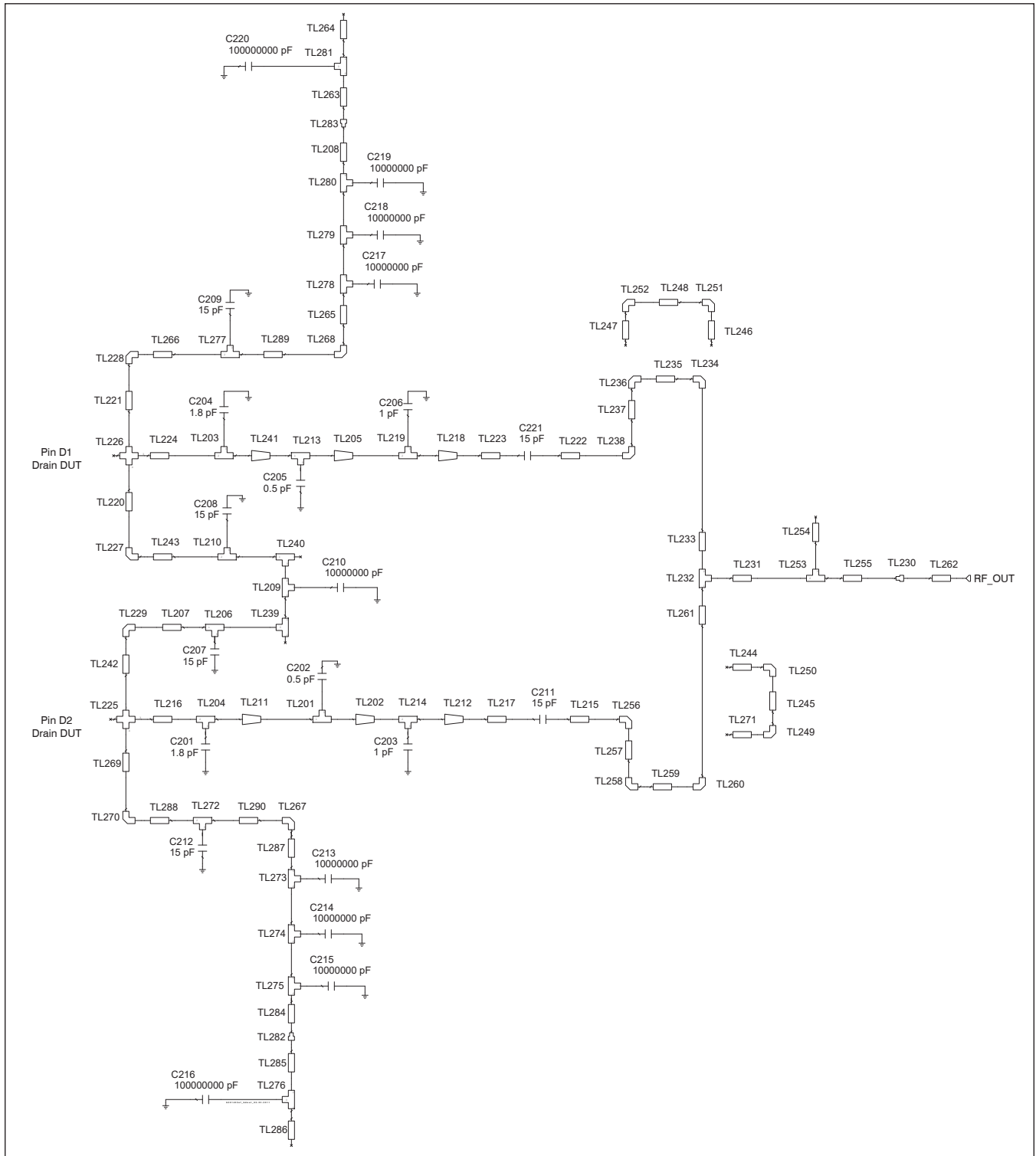

Reference circuit output schematic for  $f = 2170$  MHz

## Reference Circuit (cont.)

Description	
DUT	PTFB201402FC
PCB	0.508 mm [.020"] thick, $\epsilon_r = 3.48$ , Rogers 4350, 2 oz. copper

## Electrical Characteristics at 2170 MHz

Transmission Line	Electrical Characteristics	Dimensions: mm	Dimensions: mils
<b>Input</b>			
TL101	0.083 $\lambda$ , 52.28 $\Omega$	W = 1.077, L = 6.977	W = 42, L = 275
TL102, TL104, TL106, TL121, TL122, TL133, TL134, TL135, TL148, TL150		W = 0.001, M = 0.500	W = 1, M = 19685
TL103	0.019 $\lambda$ , 52.28 $\Omega$	W = 1.077, L = 1.567	W = 42, L = 62
TL105	0.031 $\lambda$ , 52.28 $\Omega$	W = 1.077, L = 2.565	W = 42, L = 101
TL107, TL155		W1 = 0.002, W2 = 0.001, Offset = 0.000	W1 = 2, W2 = 30, Offset = 0
TL108, TL156	0.048 $\lambda$ , 35.71 $\Omega$	W = 1.905, L = 3.912	W = 75, L = 154
TL109, TL157	0.067 $\lambda$ , 63.89 $\Omega$	W = 0.762, L = 5.636	W = 30, L = 222
TL110, TL136		W = 0.001, M = 0.300	W = 1, M = 11811
TL111	0.109 $\lambda$ , 63.89 $\Omega$	W = 0.762, L = 9.268	W = 30, L = 365
TL112, TL129	0.023 $\lambda$ , 10.63 $\Omega$	W = 8.382, L = 1.801	W = 330, L = 71
TL113, TL123	0.010 $\lambda$ , 10.63 $\Omega$	W1 = 8.382, W2 = 8.382, W3 = 0.762	W1 = 330, W2 = 330, W3 = 30
TL114, TL124 (taper)	0.072 $\lambda$ , 10.63 $\Omega$	W1 = 8.382, W2 = 1.080, L = 5.588	W1 = 330, W2 = 43, L = 220
TL115	0.032 $\lambda$ , 52.21 $\Omega$	W = 1.080, L = 2.649	W = 43, L = 104
TL116, TL131	0.012 $\lambda$ , 52.21 $\Omega$	W = 1.080, L = 0.988	W = 43, L = 39
TL117	0.029 $\lambda$ , 10.63 $\Omega$	W = 8.382, L = 2.212	W = 330, L = 87
TL118, TL119	0.064 $\lambda$ , 52.28 $\Omega$	W = 1.077, L = 5.334	W = 42, L = 210
TL120	0.019 $\lambda$ , 52.21 $\Omega$	W = 1.080, L = 1.570	W = 43, L = 62
TL125	0.082 $\lambda$ , 52.28 $\Omega$	W = 1.077, L = 6.850	W = 42, L = 270
TL126	0.022 $\lambda$ , 52.21 $\Omega$	W = 1.080, L = 1.854	W = 43, L = 73
TL127	0.031 $\lambda$ , 52.21 $\Omega$	W = 1.080, L = 2.565	W = 43, L = 101
TL128	0.138 $\lambda$ , 63.89 $\Omega$	W = 0.762, L = 11.702	W = 30, L = 461
TL130	0.028 $\lambda$ , 52.21 $\Omega$	W = 1.080, L = 2.362	W = 43, L = 93
TL132	0.029 $\lambda$ , 10.63 $\Omega$	W = 8.382, L = 2.212	W = 330, L = 87
TL137	0.085 $\lambda$ , 35.71 $\Omega$	W = 1.905, L = 6.914	W = 75, L = 272
TL138	0.023 $\lambda$ , 35.71 $\Omega$	W1 = 1.905, W2 = 1.905, W3 = 1.905	W1 = 75, W2 = 75, W3 = 75
TL139, TL140	0.037 $\lambda$ , 35.71 $\Omega$	W1 = 1.905, W2 = 1.905, W3 = 3.048	W1 = 75, W2 = 75, W3 = 120
TL141, TL142, TL146	0.023 $\lambda$ , 35.71 $\Omega$	W = 1.905, L = 1.905	W = 75, L = 75
TL143	0.076 $\lambda$ , 35.71 $\Omega$	W = 1.905, L = 6.231	W = 75, L = 245
TL144	0.030 $\lambda$ , 35.71 $\Omega$	W = 1.905, L = 2.477	W = 75, L = 98
TL145	0.046 $\lambda$ , 25.04 $\Omega$	W = 3.048, L = 3.713	W = 120, L = 146
TL147	0.042 $\lambda$ , 52.28 $\Omega$	W = 1.077, L = 3.470	W = 42, L = 137
TL149	0.020 $\lambda$ , 52.28 $\Omega$	W = 1.077, L = 1.684	W = 42, L = 66

table continued on page 9



## Reference Circuit (cont.)

## Electrical Characteristics at 2170 MHz

Transmission Line	Electrical Characteristics	Dimensions: mm	Dimensions: mils
<b>Input</b>			
TL151	0.078 $\lambda$ , 52.21 $\Omega$	W = 1.080, L = 6.561	W = 43, L = 258
TL152	0.042 $\lambda$ , 52.28 $\Omega$	W = 1.077, L = 3.472	W = 42, L = 137
TL153, TL160	0.009 $\lambda$ , 35.71 $\Omega$	W1 = 1.905, W2 = 1.905, W3 = 0.762	W1 = 75, W2 = 75, W3 = 30
TL154, TL163	0.011 $\lambda$ , 63.89 $\Omega$	W1 = 0.762, W2 = 0.762, W3 = 0.889	W1 = 30, W2 = 30, W3 = 35
TL158, TL161	0.007 $\lambda$ , 35.71 $\Omega$	W = 1.905, L = 0.610	W = 75, L = 24
TL159, TL162	0.026 $\lambda$ , 63.89 $\Omega$	W = 0.762, L = 2.184	W = 30, L = 86
TL164	0.013 $\lambda$ , 52.21 $\Omega$	W1 = 1.080, W2 = 1.080, W3 = 1.080	W1 = 43, W2 = 43, W3 = 43
<b>Output</b>			
TL201, TL213	0.000 $\lambda$ , 14.83 $\Omega$	W1 = 5.740, W2 = 5.740, W3 = 0.025	W1 = 226, W2 = 226, W3 = 1
TL202, TL205 (taper)	0.021 $\lambda$ , 14.94 $\Omega$ / 25.04 $\Omega$	W1 = 5.690, W2 = 3.048, L = 1.651	W1 = 224, W2 = 120, L = 65
TL203, TL204	0.026 $\lambda$ , 8.71 $\Omega$	W1 = 10.447, W2 = 10.447, W3 = 2.032	W1 = 411, W2 = 411, W3 = 80
TL206, TL210, TL239, TL240	0.013 $\lambda$ , 52.21 $\Omega$	W1 = 1.080, W2 = 1.080, W3 = 1.080	W1 = 43, W2 = 43, W3 = 43
TL207, TL243	0.094 $\lambda$ , 52.28 $\Omega$	W = 1.077, L = 7.882	W = 42, L = 310
TL208	0.006 $\lambda$ , 52.28 $\Omega$	W = 1.077, L = 0.516	W = 42, L = 20
TL209	0.008 $\lambda$ , 52.21 $\Omega$	W1 = 1.080, W2 = 1.080, W3 = 0.660	W1 = 43, W2 = 43, W3 = 26
TL211, TL241 (taper)	0.037 $\lambda$ , 8.73 $\Omega$ / 14.81 $\Omega$	W1 = 10.422, W2 = 5.751, L = 2.819	W1 = 410, W2 = 226, L = 111
TL212, TL218 (taper)	0.015 $\lambda$ , 25.04 $\Omega$ / 51.68 $\Omega$	W1 = 3.048, W2 = 1.097, L = 1.189	W1 = 120, W2 = 43, L = 47
TL214, TL219	0.000 $\lambda$ , 25.04 $\Omega$	W1 = 3.048, W2 = 3.048, W3 = 0.025	W1 = 120, W2 = 120, W3 = 1
TL215, TL222	0.018 $\lambda$ , 52.28 $\Omega$	W = 1.077, L = 1.516	W = 42, L = 60
TL216, TL224	0.034 $\lambda$ , 8.73 $\Omega$	W = 10.424, L = 2.604	W = 410, L = 103
TL217, TL223, TL245	0.024 $\lambda$ , 52.21 $\Omega$	W = 1.080, L = 2.032	W = 43, L = 80
TL220	0.013 $\lambda$ , 52.21 $\Omega$	W = 1.080, L = 1.097	W = 43, L = 43
TL221, TL269	0.051 $\lambda$ , 52.21 $\Omega$	W = 1.080, L = 4.239	W = 43, L = 167
TL225, TL226		W1 = 10.422, W2 = 1.080, W3 = 10.422, W4 = 1.080	W1 = 410, W2 = 43, W3 = 410, W4 = 43
TL227, TL228, TL229, TL234, TL236, TL238, TL249, TL250, TL251, TL252, TL256, TL258, TL260, TL267, TL268, TL270		W = 0.001, M = 0.500	W = 1, M = 19685
TL230		W1 = 1.880, W2 = 1.080,	W1 = 74, W2 = 43
TL231	0.043 $\lambda$ , 36.06 $\Omega$	W = 1.880, L = 3.495	W = 74, L = 138
TL232	0.022 $\lambda$ , 52.21 $\Omega$	W1 = 1.080, W2 = 1.080, W3 = 1.880	W1 = 43, W2 = 43, W3 = 74
TL233	0.081 $\lambda$ , 52.28 $\Omega$	W = 1.077, L = 6.774	W = 42, L = 267
TL235, TL259	0.023 $\lambda$ , 52.21 $\Omega$	W = 1.080, L = 1.900	W = 43, L = 75
TL237	0.052 $\lambda$ , 52.28 $\Omega$	W = 1.077, L = 4.389	W = 42, L = 173

table continued on page 10

## Reference Circuit (cont.)

## Electrical Characteristics at 2170 MHz

Transmission Line	Electrical Characteristics	Dimensions: mm	Dimensions: mils
Output			
TL242	0.010 $\lambda$ , 52.21 $\Omega$	W = 1.080, L = 0.813	W = 43, L = 32
TL244, TL271	0.060 $\lambda$ , 52.28 $\Omega$	W = 1.077, L = 5.019	W = 42, L = 198
TL246, TL247	0.024 $\lambda$ , 52.28 $\Omega$	W = 1.077, L = 2.032	W = 42, L = 80
TL248	0.023 $\lambda$ , 52.21 $\Omega$	W = 1.080, L = 1.900	W = 43, L = 75
TL253	0.023 $\lambda$ , 36.06 $\Omega$	W1 = 1.880, W2 = 1.880, W3 = 1.880	W1 = 74, W2 = 74, W3 = 74
TL254	0.300 $\lambda$ , 36.06 $\Omega$	W = 1.880, L = 24.526	W = 74, L = 966
TL255	0.212 $\lambda$ , 36.06 $\Omega$	W = 1.880, L = 17.371	W = 74, L = 684
TL257	0.164 $\lambda$ , 52.21 $\Omega$	W = 1.080, L = 13.701	W = 43, L = 539
TL261	0.306 $\lambda$ , 52.28 $\Omega$	W = 1.077, L = 25.593	W = 42, L = 1008
TL262	0.099 $\lambda$ , 52.28 $\Omega$	W = 1.077, L = 8.247	W = 42, L = 325
TL263	0.012 $\lambda$ , 14.50 $\Omega$	W = 5.893, L = 0.965	W = 232, L = 38
TL264	0.102 $\lambda$ , 14.50 $\Omega$	W = 5.893, L = 7.976	W = 232, L = 314
TL265	0.006 $\lambda$ , 52.28 $\Omega$	W = 1.077, L = 0.533	W = 42, L = 21
TL266	0.092 $\lambda$ , 52.28 $\Omega$	W = 1.077, L = 7.696	W = 42, L = 303
TL272, TL277	0.024 $\lambda$ , 52.21 $\Omega$	W1 = 1.080, W2 = 1.080, W3 = 2.032	W1 = 43, W2 = 43, W3 = 80
TL273	0.009 $\lambda$ , 52.21 $\Omega$	W1 = 1.080, W2 = 1.080, W3 = 0.762	W1 = 43, W2 = 43, W3 = 30
TL274, TL275	0.030 $\lambda$ , 52.21 $\Omega$	W1 = 1.080, W2 = 1.080, W3 = 2.540	W1 = 43, W2 = 43, W3 = 100
TL276	0.019 $\lambda$ , 14.50 $\Omega$	W1 = 5.893, W2 = 5.893, W3 = 1.524	W1 = 232, W2 = 232, W3 = 60
TL278, TL279, TL280	0.030 $\lambda$ , 52.21 $\Omega$	W1 = 1.080, W2 = 1.080, W3 = 2.489	W1 = 43, W2 = 43, W3 = 98
TL281	0.019 $\lambda$ , 14.50 $\Omega$	W1 = 5.893, W2 = 5.893, W3 = 1.524	W1 = 232, W2 = 232, W3 = 60
TL282		W1 = 0.001, W2 = 0.005, Offset = 0.000	W1 = 1, W2 = 180, Offset = 0
TL283		W1 = 0.001, W2 = 0.005, Offset = 0.001	W1 = 1, W2 = 180, Offset = 37
TL284	0.016 $\lambda$ , 52.28 $\Omega$	W = 1.077, L = 1.303	W = 42, L = 51
TL285	0.035 $\lambda$ , 14.50 $\Omega$	W = 5.893, L = 2.743	W = 232, L = 108
TL286	0.079 $\lambda$ , 14.50 $\Omega$	W = 5.893, L = 6.198	W = 232, L = 244
TL287	0.016 $\lambda$ , 52.28 $\Omega$	W = 1.077, L = 1.372	W = 42, L = 54
TL288	0.084 $\lambda$ , 52.28 $\Omega$	W = 1.077, L = 6.985	W = 42, L = 275
TL289	0.027 $\lambda$ , 52.28 $\Omega$	W = 1.077, L = 2.258	W = 42, L = 89
TL290	0.024 $\lambda$ , 52.28 $\Omega$	W = 1.077, L = 2.029	W = 42, L = 80



### Reference Circuit (cont.)

#### Circuit Assembly Information

Test Fixture Part No. LTD/PTFB201402FC

Find Gerber files for this test fixture on the Wolfspeed Web site at [www.wolfspeed.com/RF](http://www.wolfspeed.com/RF)

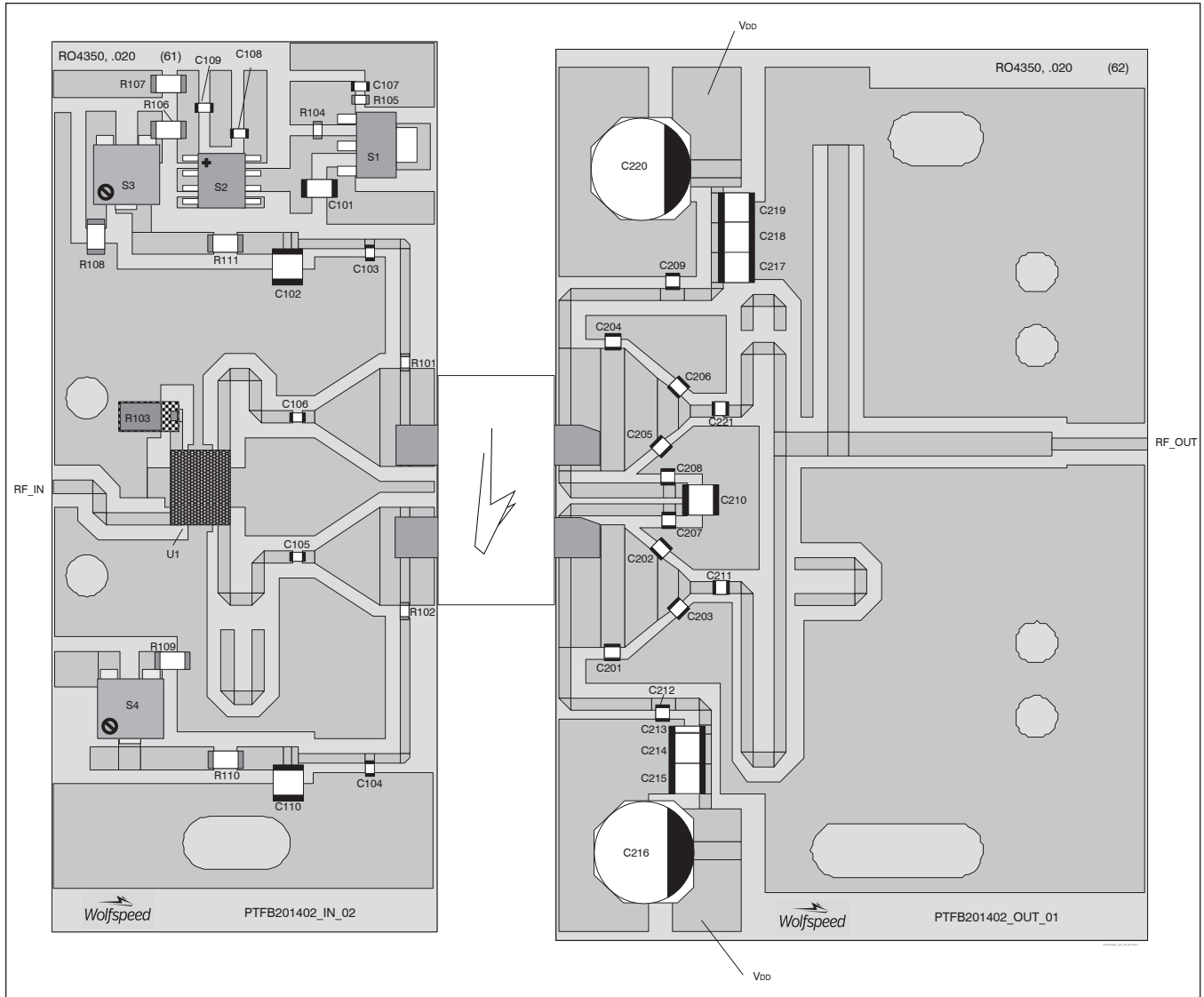

Reference circuit assembly diagram (not to scale)

## Reference Circuit (cont.)

## Component Information

Component	Description	Suggested Manufacturer	P/N
<b>Input</b>			
C101	Chip capacitor, 1 $\mu\text{F}$	ATC	490-1863-2-ND
C102, C110	Capacitor, 10 $\mu\text{F}$	Digi-Key	587-1818-2-ND
C103, C104, C105, C106	Chip capacitor, 15 pF	ATC	ATC100A150JW150XB
C107, C108, C109	Chip capacitor, 0.1 $\mu\text{F}$	ATC	PCC1772CT-ND
R101, R102	Resistor, 10 $\Omega$	Digi-Key	P10GCT-ND
R103	Resistor, 50 $\Omega$	Digi-Key	C16A50Z4
R104	Resistor, 1200 $\Omega$	Digi-Key	P1.2KGCT-ND
R105	Resistor, 1300 $\Omega$	Digi-Key	P1.3KGCT-ND
R106, R107	Resistor, 100 $\Omega$	Digi-Key	P100ECT-ND
R108, R109	Resistor, 10 $\Omega$	Digi-Key	P10ECT-ND
R110, R111	Resistor, 1000 $\Omega$	Digi-Key	P1.0KECT-ND
S1	Transistor	Digi-Key	BCP5616TA-ND
S2	Voltage Regulator	Digi-Key	LM78L05ACM-ND
S3, S4	Potentiometer, 2k $\Omega$	Digi-Key	3224W-202ECT-ND
U1	Hybrid coupler, 50 $\Omega$	Anaren	X3C19P1-035
<b>Output</b>			
C201, C204	Chip capacitor, 1.8 pF	ATC	ATC800A1R8BW150XB
C202, C205	Chip capacitor, 0.5 pF	ATC	ATC800A1R8BW150XB
C203, C206	Chip capacitor, 1 pF	ATC	ATC800A1R0BW150XB
C207, C208, C209, C211, C212	Chip capacitor, 15 pF	ATC	ATC800A150FW150XB
C210, C214, C215, C217, C218, C219	Capacitor, 10 $\mu\text{F}$	Digi-Key	587-1818-2-ND
C213	Capacitor, 10 $\mu\text{F}$	Digi-Key	399-1267-2-ND
C216, C220	Capacitor, 100 $\mu\text{F}$	Digi-Key	PCE4442TR-ND
C221	Chip capacitor, 15 pF	ATC	ATC100A150FW150XB

## Pinout Diagram

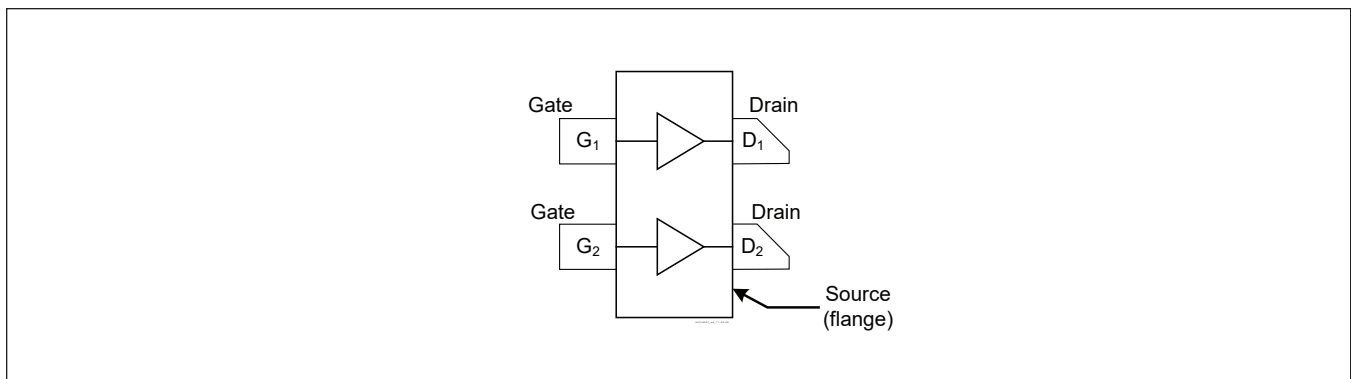

Lead connections for PTFB201402FC

## Package Outline Specifications

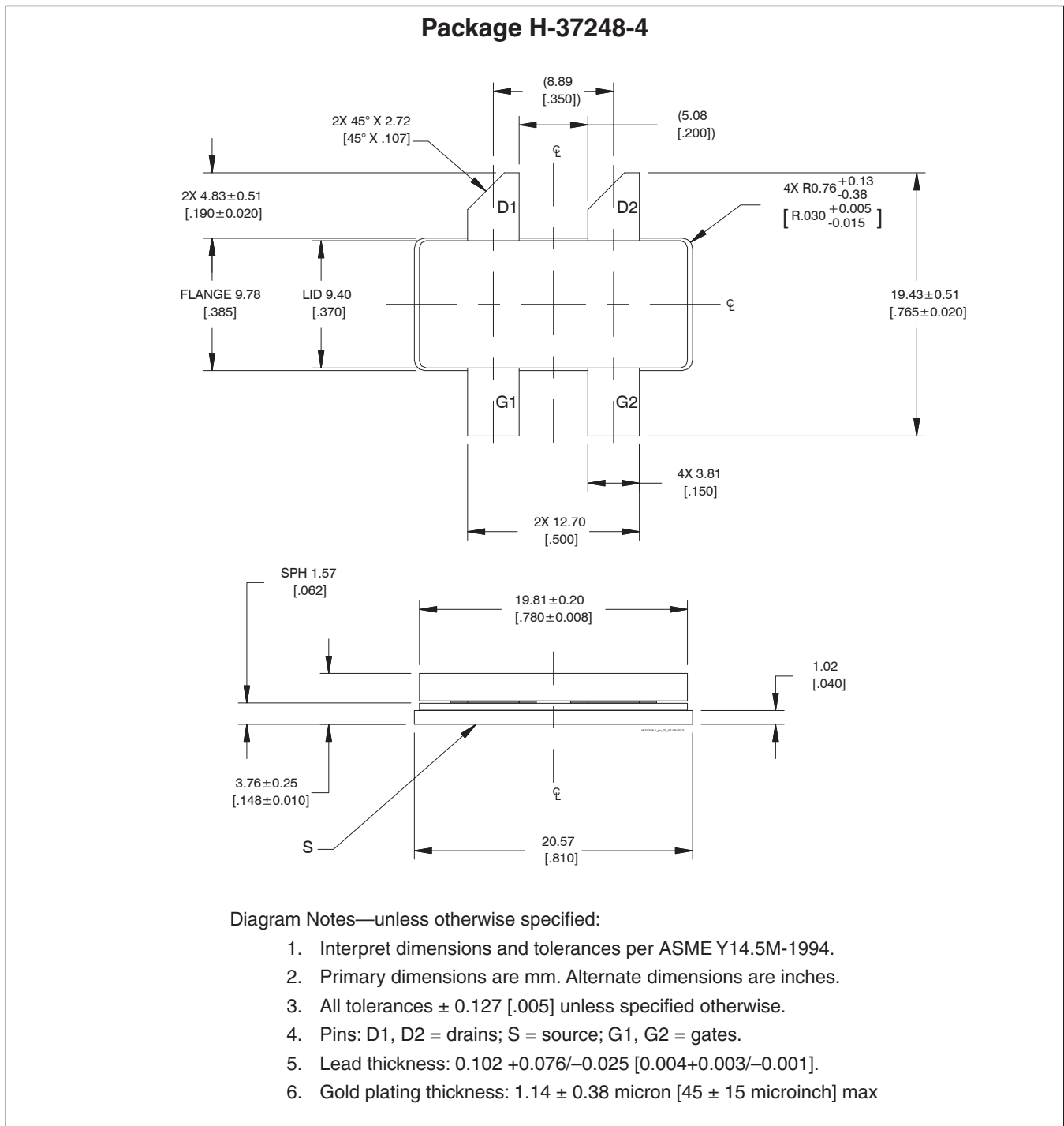

## Revision History

Revision	Date	Data Sheet Type	Page	Subjects (major changes since last revision)
01	2011-03-16	Preliminary	All	Data Sheet reflects preliminary specification
02	2011-11-08	Preliminary	2	Corrected the data sheet from V2 to V1
03	2012-02-16	Production	All	Finalize data and remove preliminary designation
03.1	2016-06-04	Production	2	Updated ordering information to include R0
04	2018-06-25	Production	All	Converted to Wolfspeed Data Sheet

For more information, please contact:

4600 Silicon Drive  
 Durham, North Carolina, USA 27703  
[www.wolfspeed.com/RF](http://www.wolfspeed.com/RF)

Sales Contact  
[RFSales@wolfspeed.com](mailto:RFSales@wolfspeed.com)

RF Product Marketing Contact  
[RFMarketing@wolfspeed.com](mailto:RFMarketing@wolfspeed.com)  
 919.407.7816

## Notes

---

### Disclaimer

Specifications are subject to change without notice. Cree, Inc. believes the information contained within this data sheet to be accurate and reliable. However, no responsibility is assumed by Cree for any infringement of patents or other rights of third parties which may result from its use. No license is granted by implication or otherwise under any patent or patent rights of Cree. Cree makes no warranty, representation or guarantee regarding the suitability of its products for any particular purpose. "Typical" parameters are the average values expected by Cree in large quantities and are provided for information purposes only. These values can and do vary in different applications and actual performance can vary over time. All operating parameters should be validated by customer's technical experts for each application. Cree products are not designed, intended or authorized for use as components in applications intended for surgical implant into the body or to support or sustain life, in applications in which the failure of the Cree product could result in personal injury or death or in applications for planning, construction, maintenance or direct operation of a nuclear facility.