

## Thermally-Enhanced High Power RF LDMOS FETs 150 W, 2110 – 2170 MHz

### Description

The PTFB211501E and PTFB211501F are thermally-enhanced, 150-watt, LDMOS FETs designed for cellular power amplifier applications in the 2110 – 2170 frequency band. Features include I/O matching, high gain, and thermally-enhanced ceramic open-cavity packages with slotted and earless flanges.

PTFB211501E  
 Package H-36248-2



PTFB211501F  
 Package H-37248-2

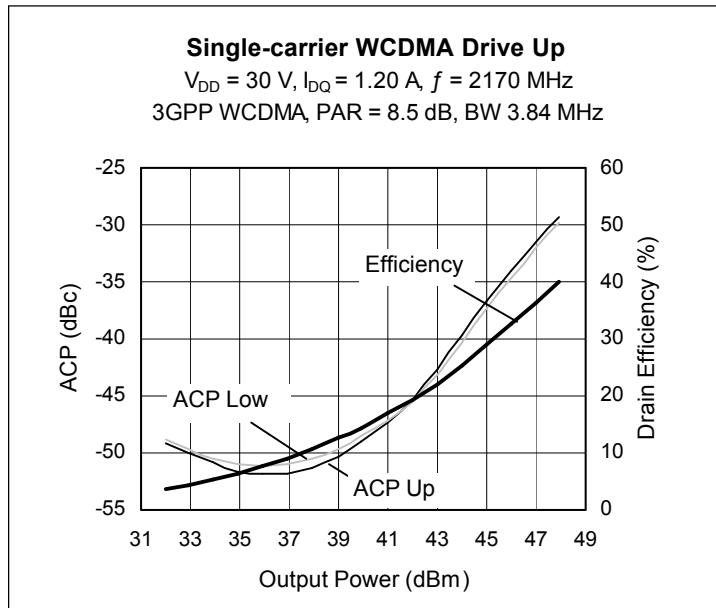

### Features

- Broadband internal matching
- Typical single-carrier WCDMA performance at 2170 MHz, 30 V,  $I_{DQ} = 1.2\text{ A}$ , 3GPP signal, channel bandwidth = 3.84 MHz, PAR = 8.5 dB @ 0.01% CCDF
  - Average output power = 40 W
  - Linear Gain = 18 dB
  - Efficiency = 32%
  - Adjacent channel power = -34 dBc
- Typical CW performance, 2170 MHz, 30 V
  - Output power at P-1dB = 150 W
  - Efficiency = 55%
- Integrated ESD protection: Human Body Model, Class 2 (minimum)
- Capable of handling 10:1 VSWR @ 30 V, 150 W (CW) output power
- Pb-Free and RoHS compliant

### RF Characteristics

#### Single-carrier WCDMA Measurements (tested in Infineon test fixture)

$V_{DD} = 30\text{ V}$ ,  $I_{DQ} = 1.2\text{ A}$ ,  $P_{OUT} = 40\text{ W AVG}$ ,  $f = 2170\text{ MHz}$ , 3GPP signal, channel bandwidth = 3.84 MHz, peak/average = 8.5 dB @ 0.01% CCDF

Characteristic	Symbol	Min	Typ	Max	Unit
Gain	$G_{ps}$	17	18	—	dB
Drain Efficiency	$\eta_D$	27	32	—	%
Intermodulation Distortion	IMD	—	-34	-32	dBc

All published data at  $T_{CASE} = 25^\circ\text{C}$  unless otherwise indicated

**ESD:** Electrostatic discharge sensitive device—observe handling precautions!

## RF Characteristics (cont.)

**Two-tone Measurement** (not subject to production test - verified by design / characterization in Infineon test fixture)

$V_{DD} = 30\text{ V}$ ,  $I_{DQ} = 1.2\text{ A}$ ,  $P_{OUT} = 140\text{ W PEP}$ ,  $f = 2170\text{ MHz}$ , tone spacing = 1 MHz

Characteristic	Symbol	Min	Typ	Max	Unit
Gain	$G_{ps}$	—	18	—	dB
Drain Efficiency	$\eta_D$	—	40	—	%
Intermodulation Distortion	IMD	—	-30	—	dBc

## DC Characteristics

Characteristic	Conditions	Symbol	Min	Typ	Max	Unit
Drain-Source Breakdown Voltage	$V_{GS} = 0\text{ V}$ , $I_{DS} = 10\text{ }\mu\text{A}$	$V_{(BR)DSS}$	65	—	—	V
Drain Leakage Current	$V_{DS} = 28\text{ V}$ , $V_{GS} = 0\text{ V}$	$I_{DSS}$	—	—	1.0	$\mu\text{A}$
	$V_{DS} = 63\text{ V}$ , $V_{GS} = 0\text{ V}$	$I_{DSS}$	—	—	10.0	$\mu\text{A}$
On-State Resistance	$V_{GS} = 10\text{ V}$ , $V_{DS} = 0.1\text{ V}$	$R_{DS(on)}$	—	0.08	—	$\Omega$
Operating Gate Voltage	$V_{DS} = 30\text{ V}$ , $I_{DQ} = 1.2\text{ A}$	$V_{GS}$	1.6	2.1	3.0	V
Gate Leakage Current	$V_{GS} = 10\text{ V}$ , $V_{DS} = 0\text{ V}$	$I_{GSS}$	—	—	1.0	$\mu\text{A}$

## Maximum Ratings

Parameter	Symbol	Value	Unit
Drain-Source Voltage	$V_{DSS}$	65	V
Gate-Source Voltage	$V_{GS}$	-6 to +10	V
Junction Temperature	$T_J$	200	$^{\circ}\text{C}$
Storage Temperature Range	$T_{STG}$	-40 to +150	$^{\circ}\text{C}$
Thermal Resistance ( $T_{CASE} = 70^{\circ}\text{C}$ , 150 W CW)	$R_{\theta JC}$	0.29	$^{\circ}\text{C/W}$

## Ordering Information

Type and Version	Ordering Code	Package Description	Shipping
PTFB211501E V1 R0	PTFB211501EV1R0XTMA1	H-36248-2, bolt-down	Tape & Reel, 50 pcs
PTFB211501E V1 R250	PTFB211501EV1R250XTMA1	H-36248-2, bolt-down	Tape & Reel, 250 pcs
PTFB211501F V1 R0	PTFB211501FV1R0XTMA1	H-37248-2, earless flange	Tape & Reel, 50pcs
PTFB211501F V1 R250	PTFB211501FV1R250XTMA1	H-37248-2, earless flange	Tape & Reel, 250 pcs

**Typical Performance** (data taken in production test fixture)

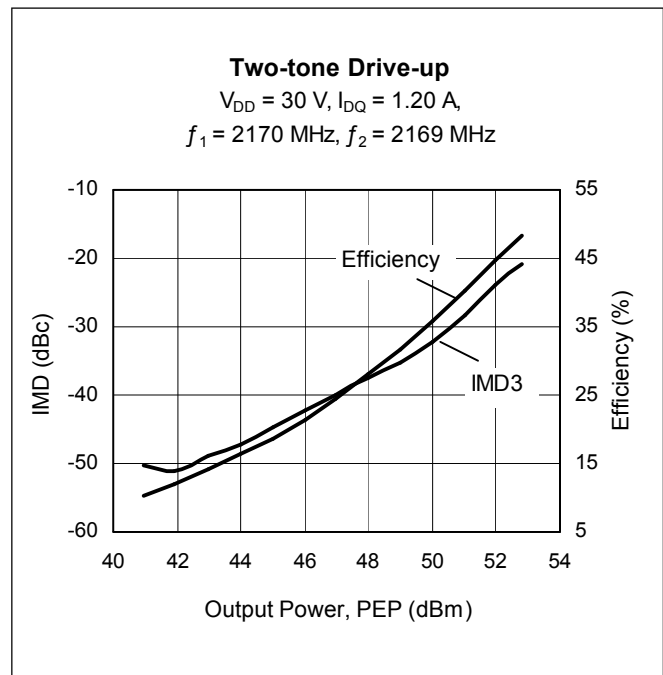
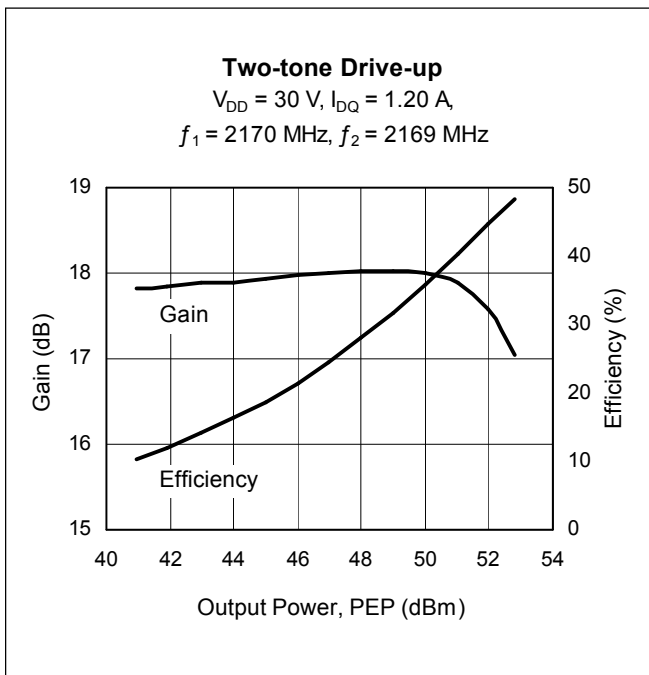
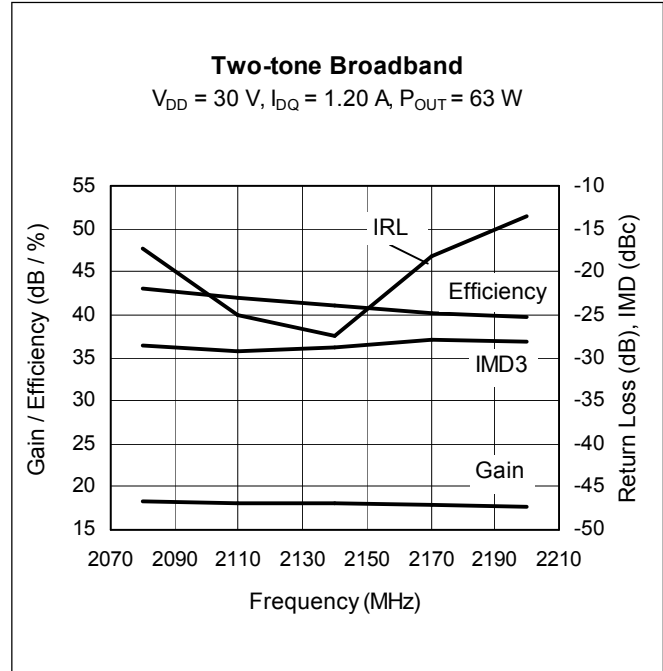
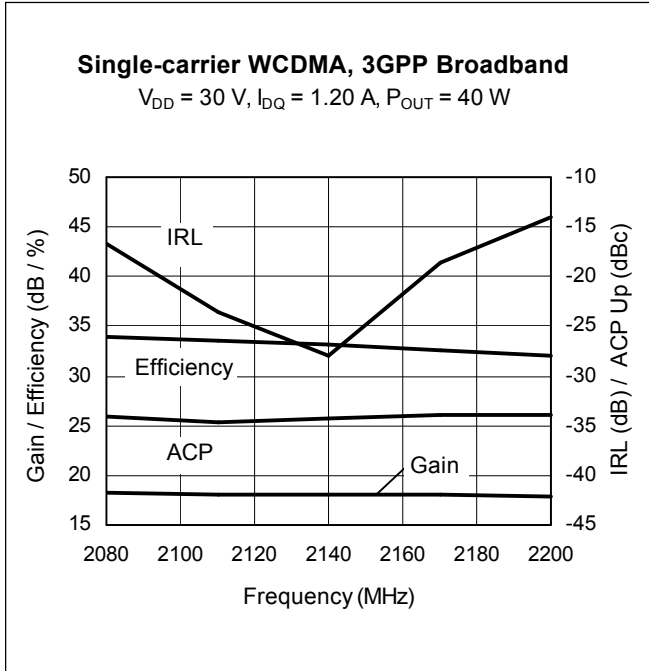

Typical Performance (cont.)

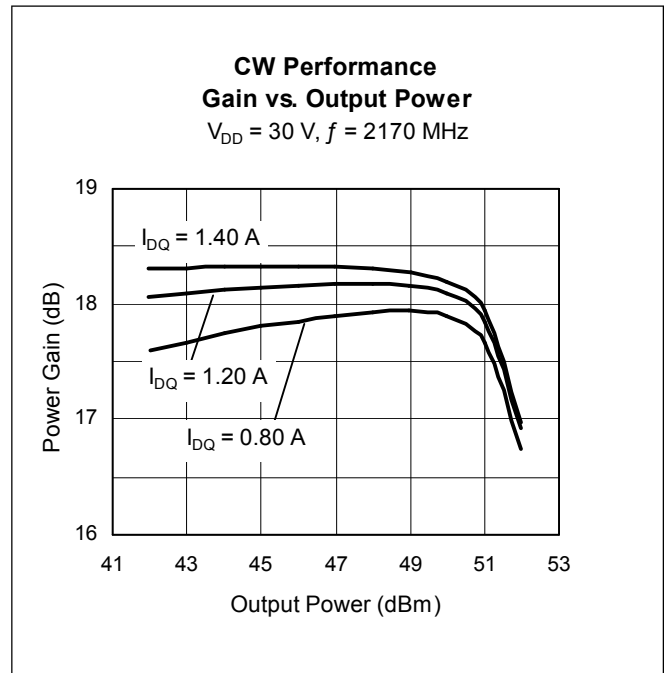
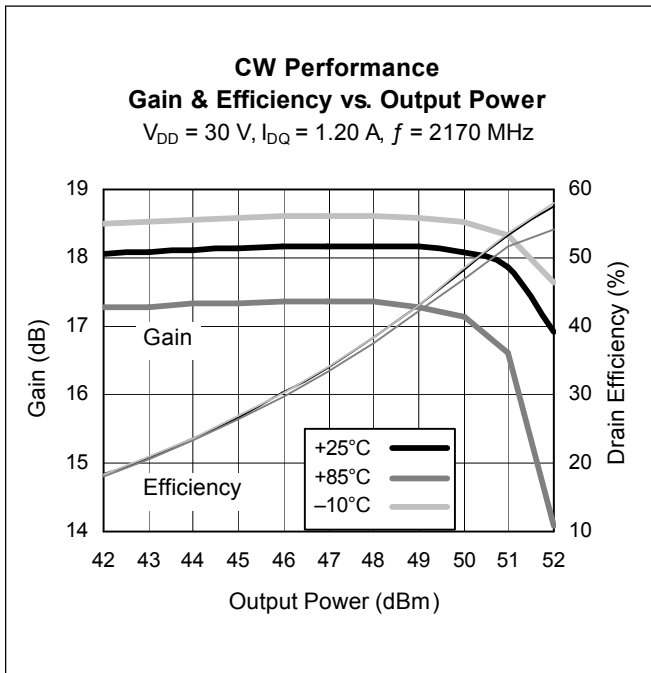
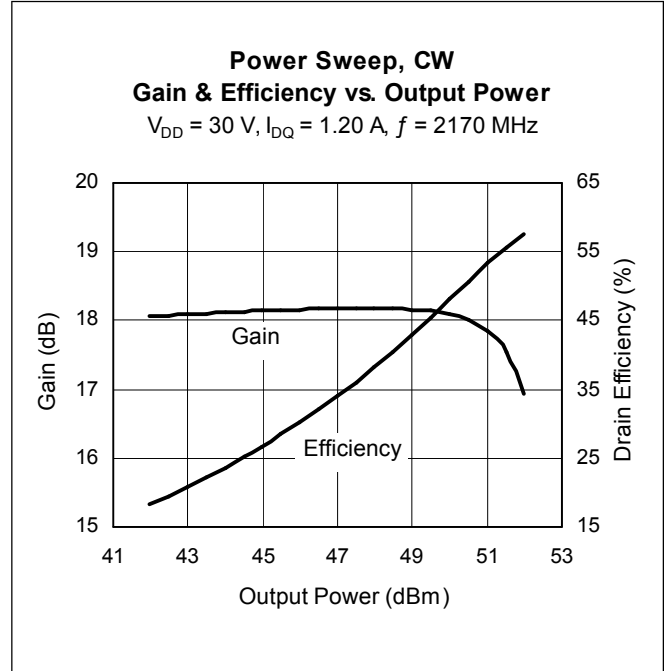
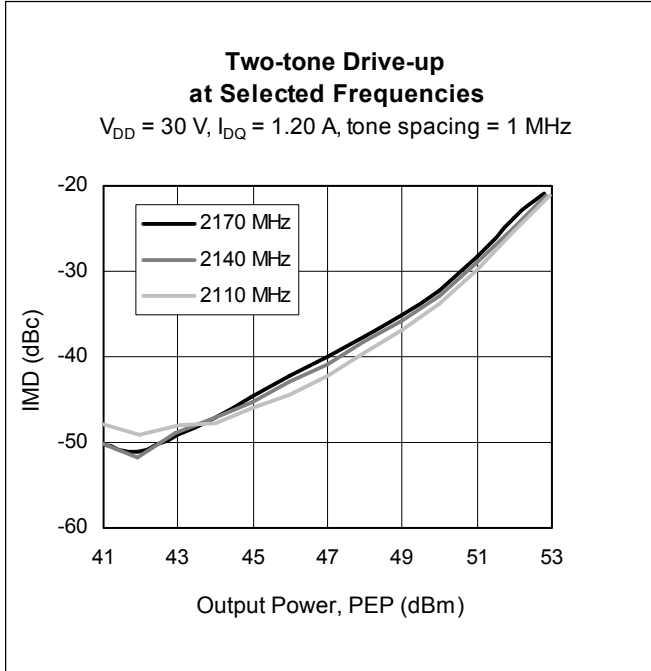

Typical Performance (cont.)

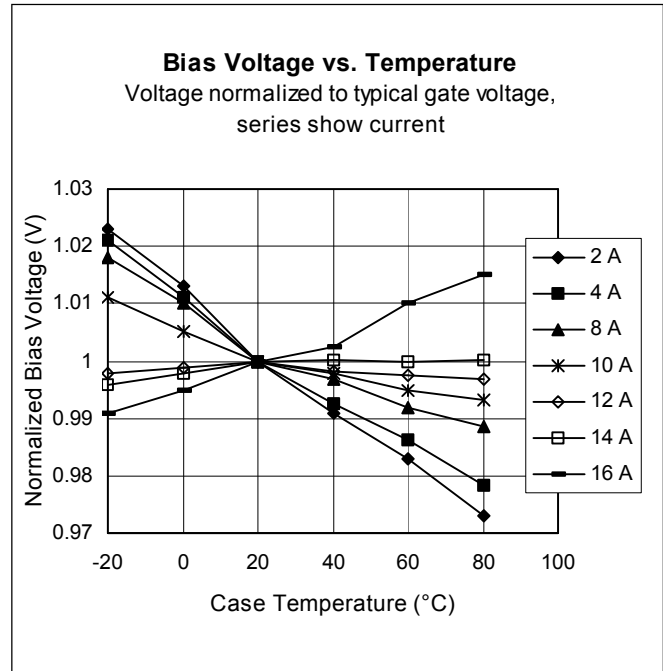
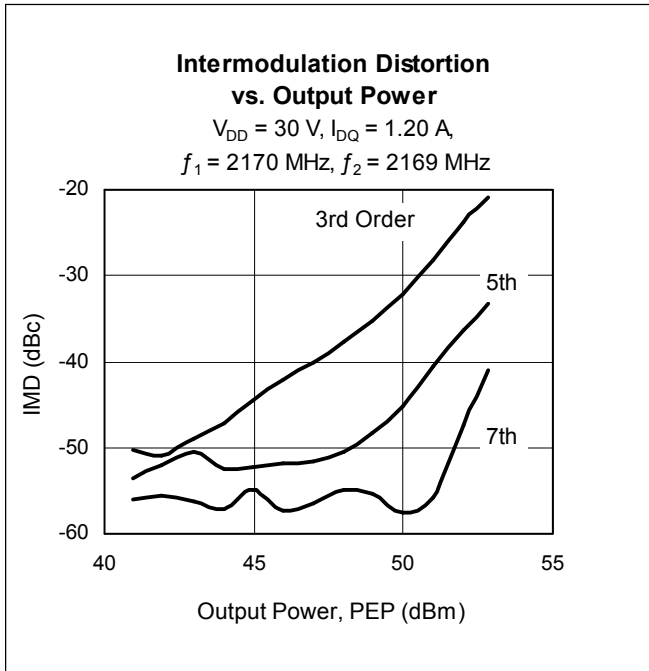

Broadband Circuit Impedance

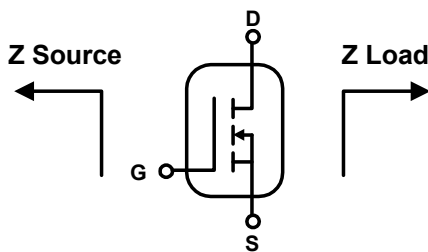

Frequency MHz	Z Source W		Z Load W	
	R	jX	R	jX
2200	4.29	-8.14	1.49	-4.39
2170	4.36	-8.34	1.52	-4.50
2140	4.45	-8.53	1.55	-4.61
2110	4.55	-8.74	1.58	-4.72
2080	4.67	-8.95	1.62	-4.84

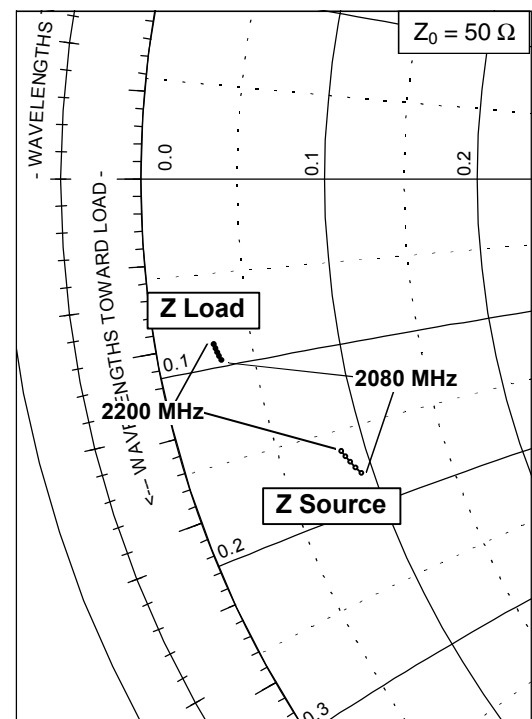

Reference Circuit

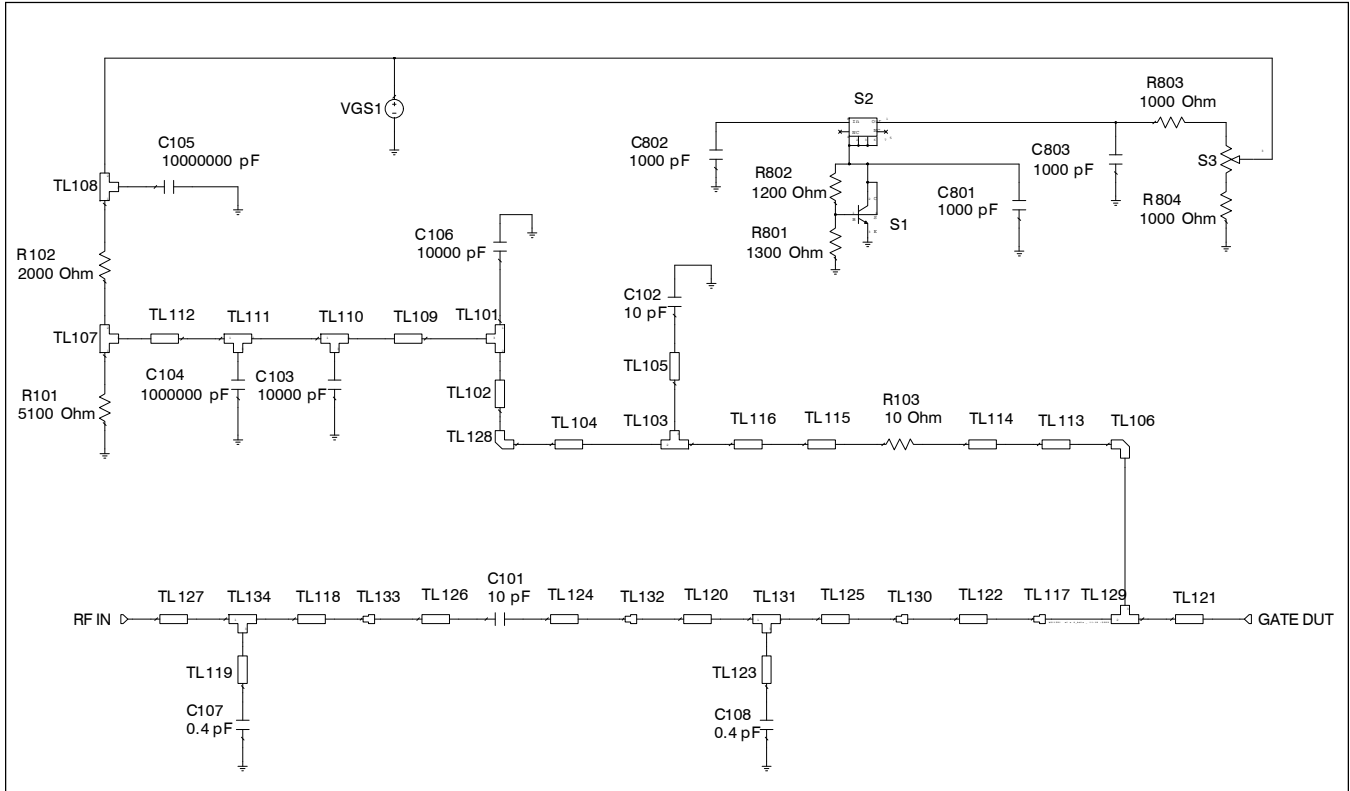

Reference circuit input schematic for  $f = 2170$  MHz

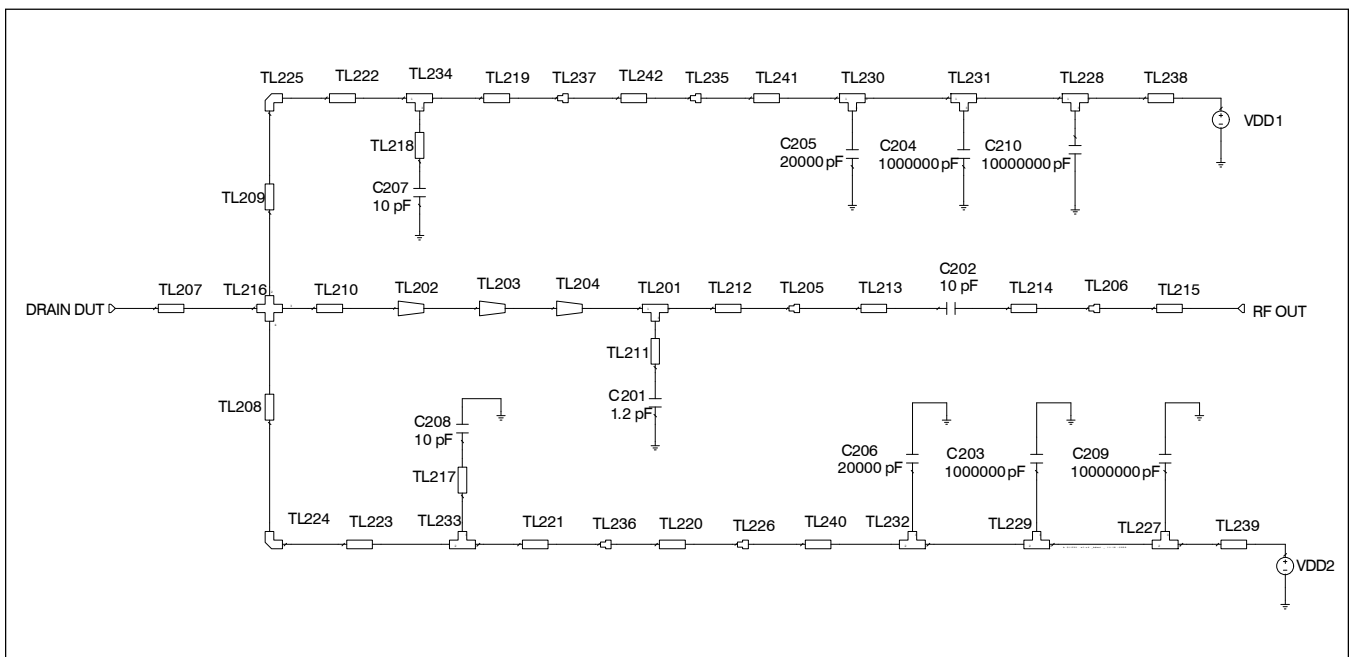

Reference circuit output schematic for  $f = 2170$  MHz

Reference Circuit (cont.)

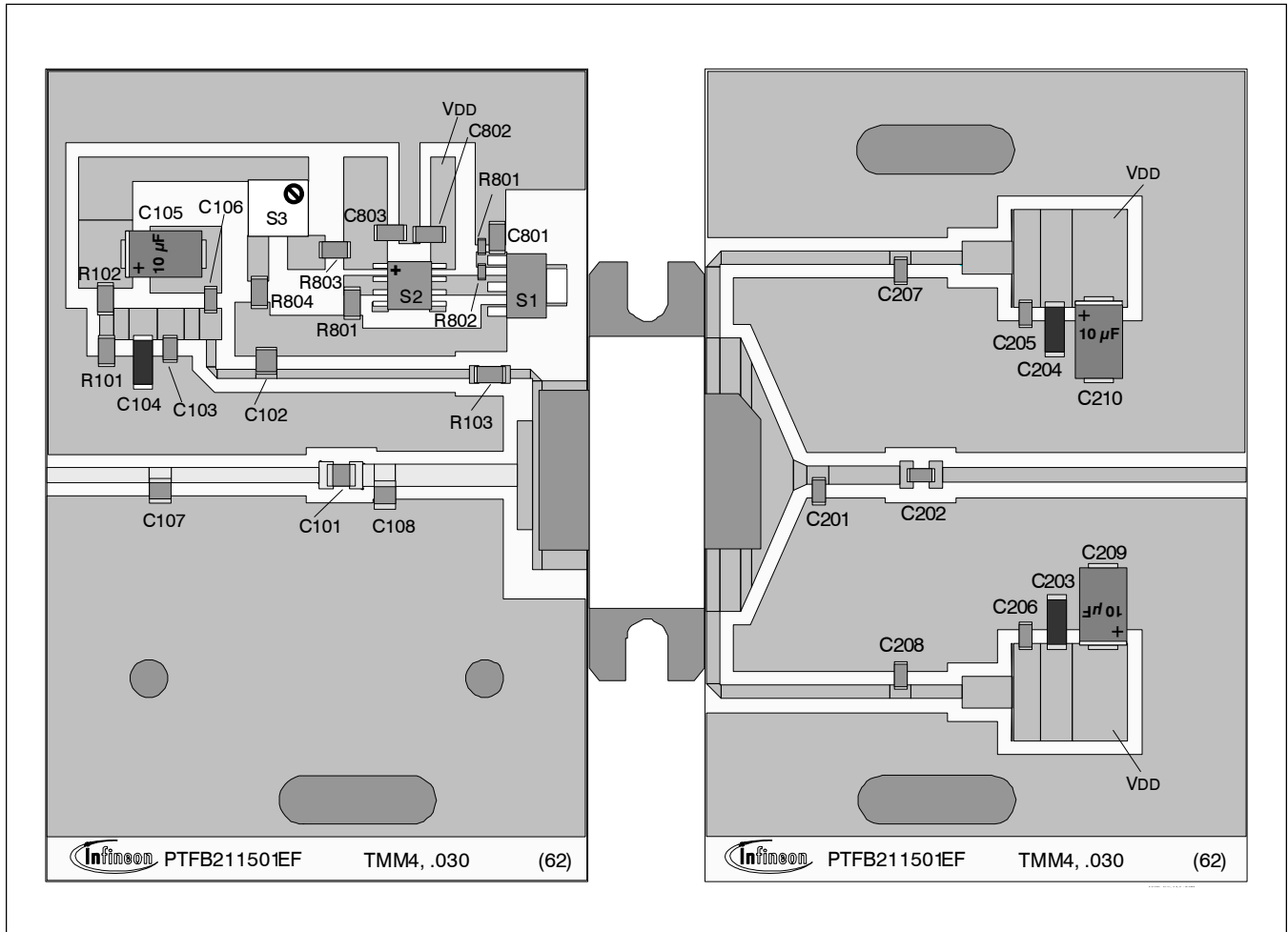

Reference circuit assembly diagram (not to scale)\*

\* Gerber Files for this circuit available on request

## Reference Circuit (cont.)

### Circuit Assembly Information

DUT	PTFB211501E or PTFB211501F		LDMOS Transistor	
PCB	LTN/PTFB211501EF	0.76 mm [.030"] thick, $\epsilon_r = 4.5$	TMM4	2 oz. copper

Component	Description	Suggested Manufacturer	P/N
<b>Input</b>			
C101, C102	Chip capacitor, 10 pF	ATC	100B100JW500X
C103, C106	Chip capacitor, 0.01 $\mu$ F	ATC	200B103MW50X
C104	Chip capacitor, 1 $\mu$ F	Digi-Key	445-1411-2-ND
C105	Capacitor, 10 $\mu$ F	Digi-Key	399-1655-2-ND
C107, C108	Chip capacitor, 0.4 pF	ATC	100B0R4CW500X
C801, C802, C803	Chip capacitor, 1000 pF	Digi-Key	PCC1772CT-ND
R101	Resistor, 5100 $\Omega$	Digi-Key	P5.1KECT-ND
R102	Resistor, 2000 $\Omega$	Digi-Key	P2.0KECT-ND
R103	Resistor, 10 $\Omega$	Digi-Key	P10ECT-ND
R801	Resistor, 1300 $\Omega$	Digi-Key	P1.3KECT-ND
R802	Resistor, 1200 $\Omega$	Digi-Key	P1.2KECT-ND
R803, R804	Resistor, 1000 $\Omega$	Digi-Key	P1.0KECT-ND
S1	Transistor	Infineon Technologies	BCP56
S2	Voltage regulator	National Semiconductor	LM7805
S3	Potentiometer, 2k $\Omega$	Digi-Key	3224W-202ECT-ND
<b>Output</b>			
C201	Chip capacitor, 1.2 pF	ATC	100B1R2CW500X
C202	Chip capacitor, 10 pF	ATC	100B100JW500X
C203, C204	Chip capacitor, 1 $\mu$ F	Digi-Key	445-1411-2-ND
C205, C206	Chip capacitor, 0.02 $\mu$ F	ATC	200B203MW50X
C207, C208	Chip capacitor, 10 pF	ATC	100B100JW500X
C209, C210	Capacitor, 10 $\mu$ F	Garrett Electronics	TPSE106K050R0400



Reference Circuit (cont.)

Electrical Characteristics at 2170 MHz

Transmission Line	Electrical Characteristics	Dimensions: mm	Dimensions: mils
<b>Input</b>			
TL101	0.041 $\lambda$ , 40.30 $\Omega$	W1 = 2.032, W2 = 2.032, W3 = 3.048	W1 = 80, W2 = 80, W3 = 120
TL102	0.033 $\lambda$ , 65.15 $\Omega$	W = 0.889, L = 2.540	W = 35, L = 100
TL103	0.027 $\lambda$ , 65.15 $\Omega$	W1 = 0.889, W2 = 0.889, W3 = 2.032	W1 = 35, W2 = 35, W3 = 80
TL104	0.047 $\lambda$ , 65.15 $\Omega$	W = 0.889, L = 3.556	W = 35, L = 140
TL105	0.000 $\lambda$ , 40.30 $\Omega$	W = 2.032, L = 0.025	W = 80, L = 1
TL106, TL128		W = 0.889	W = 35
TL107	0.040 $\lambda$ , 53.88 $\Omega$	W1 = 1.270, W2 = 1.270, W3 = 3.048	W1 = 50, W2 = 50, W3 = 120
TL108	0.089 $\lambda$ , 20.46 $\Omega$	W1 = 5.080, W2 = 5.080, W3 = 6.350	W1 = 200, W2 = 200, W3 = 50
TL109, TL112	0.021 $\lambda$ , 30.35 $\Omega$	W = 3.048, L = 1.524	W = 120, L = 60
TL110, TL111	0.035 $\lambda$ , 30.35 $\Omega$	W1 = 3.048, W2 = 3.048, W3 = 2.540	W1 = 120, W2 = 120, W3 = 100
TL113	0.025 $\lambda$ , 65.15 $\Omega$	W = 0.889, L = 1.905	W = 35, L = 75
TL114, TL115	0.012 $\lambda$ , 46.07 $\Omega$	W = 1.651, L = 0.889	W = 65, L = 35
TL116	0.236 $\lambda$ , 65.15 $\Omega$	W = 0.889, L = 18.034	W = 35, L = 710
TL117		W1 = 10.160, W2 = 17.780	W1 = 400, W2 = 700
TL118	0.186 $\lambda$ , 50.98 $\Omega$	W = 1.397, L = 13.970	W = 55, L = 550
TL119, TL123	0.000 $\lambda$ , 40.30 $\Omega$	W = 2.032, L = 0.025	W = 80, L = 1
TL120	0.014 $\lambda$ , 40.30 $\Omega$	W = 2.032, L = 1.016	W = 80, L = 40
TL121	0.062 $\lambda$ , 6.87 $\Omega$	W = 17.780, L = 4.191	W = 700, L = 165
TL122	0.020 $\lambda$ , 11.38 $\Omega$	W = 10.160, L = 1.397	W = 400, L = 55
TL124, TL126	0.017 $\lambda$ , 34.60 $\Omega$	W = 2.540, L = 1.270	W = 100, L = 50
TL125	0.155 $\lambda$ , 40.30 $\Omega$	W = 2.032, L = 11.430	W = 80, L = 450
TL127	0.127 $\lambda$ , 50.98 $\Omega$	W = 1.397, L = 9.525	W = 55, L = 375
TL129	0.013 $\lambda$ , 6.87 $\Omega$	W1 = 17.780, W2 = 17.780, W3 = 0.889	W1 = 700, W2 = 700, W3 = 35
TL130		W1 = 2.032, W2 = 10.160	W1 = 80, W2 = 400
TL131	0.027 $\lambda$ , 40.30 $\Omega$	W1 = 2.032, W2 = 2.032, W3 = 2.032	W1 = 80, W2 = 80, W3 = 80
TL132		W1 = 2.540, W2 = 2.032	W1 = 100, W2 = 80
TL133		W1 = 1.397, W2 = 2.540	W1 = 55, W2 = 100
TL134	0.027 $\lambda$ , 50.98 $\Omega$	W1 = 1.397, W2 = 1.397, W3 = 2.032	W1 = 55, W2 = 55, W3 = 80

## Reference Circuit (cont.)

### Electrical Characteristics at 2170 MHz

Transmission Line	Electrical Characteristics	Dimensions: mm	Dimensions: mils
<b>Output</b>			
TL201	0.027 $\lambda$ , 43.96 $\Omega$	W1 = 1.778, W2 = 1.778, W3 = 2.032	W1 = 70, W2 = 70, W3 = 80
TL202 (taper)	0.016 $\lambda$ , 4.88 $\Omega$ / 5.86 $\Omega$	W1 = 25.654, W2 = 21.107, L = 1.041	W1 = 1010, W2 = 831, L = 41
TL203 (taper)	0.058 $\lambda$ , 5.86 $\Omega$ / 32.33 $\Omega$	W1 = 21.107, W2 = 2.794, L = 3.937	W1 = 831, W2 = 110, L = 155
TL204 (taper)	0.017 $\lambda$ , 32.33 $\Omega$ / 43.96 $\Omega$	W1 = 2.794, W2 = 1.778, L = 1.270	W1 = 110, W2 = 70, L = 50
TL205		W1 = 1.778, W2 = 2.540	W1 = 70, W2 = 100
TL206		W1 = 2.540, W2 = 1.397	W1 = 100, W2 = 55
TL207	0.000 $\lambda$ , 4.88 $\Omega$	W = 25.654, L = 0.025	W = 1010, L = 1
TL208, TL209	0.089 $\lambda$ , 53.88 $\Omega$	W = 1.270, L = 6.731	W = 50, L = 265
TL210	0.028 $\lambda$ , 4.88 $\Omega$	W = 25.654, L = 1.905	W = 1010, L = 75
TL211, TL217, TL218	0.000 $\lambda$ , 40.30 $\Omega$	W = 2.032, L = 0.025	W = 80, L = 1
TL212	0.089 $\lambda$ , 43.96 $\Omega$	W = 1.778, L = 6.604	W = 70, L = 260
TL213, TL214	0.017 $\lambda$ , 34.60 $\Omega$	W = 2.540, L = 1.270	W = 100, L = 50
TL215	0.378 $\lambda$ , 50.98 $\Omega$	W = 1.397, L = 28.423	W = 55, L = 1119
TL216		W1 = 25.654, W2 = 1.270, W3 = 25.654, W4 = 1.270	W1 = 1010, W2 = 50, W3 = 1010, W4 = 50
TL219, TL221	0.062 $\lambda$ , 53.88 $\Omega$	W = 1.270, L = 4.699	W = 50, L = 185
TL220, TL242	0.065 $\lambda$ , 30.35 $\Omega$	W = 3.048, L = 4.699	W = 120, L = 185
TL222, TL223	0.209 $\lambda$ , 53.88 $\Omega$	W = 1.270, L = 15.748	W = 50, L = 620
TL224, TL225		W = 1.270	W = 50
TL226, TL235		W1 = 3.048, W2 = 9.144	W1 = 120, W2 = 360
TL227, TL228	0.073 $\lambda$ , 12.48 $\Omega$	W1 = 9.144, W2 = 9.144, W3 = 5.080	W1 = 360, W2 = 360, W3 = 200
TL229, TL231	0.044 $\lambda$ , 12.48 $\Omega$	W1 = 9.144, W2 = 9.144, W3 = 3.048	W1 = 360, W2 = 360, W3 = 120
TL230, TL232	0.037 $\lambda$ , 12.48 $\Omega$	W1 = 9.144, W2 = 9.144, W3 = 2.540	W1 = 360, W2 = 360, W3 = 100
TL233, TL234	0.027 $\lambda$ , 53.88 $\Omega$	W1 = 1.270, W2 = 1.270, W3 = 2.032	W1 = 50, W2 = 50, W3 = 80
TL236, TL237		W1 = 1.270, W2 = 3.048,	W1 = 50, W2 = 120
TL238, TL239, TL240, TL241	0.002 $\lambda$ , 12.48 $\Omega$	W = 9.144, L = 0.127	W = 360, L = 5

### Package Outline Specifications

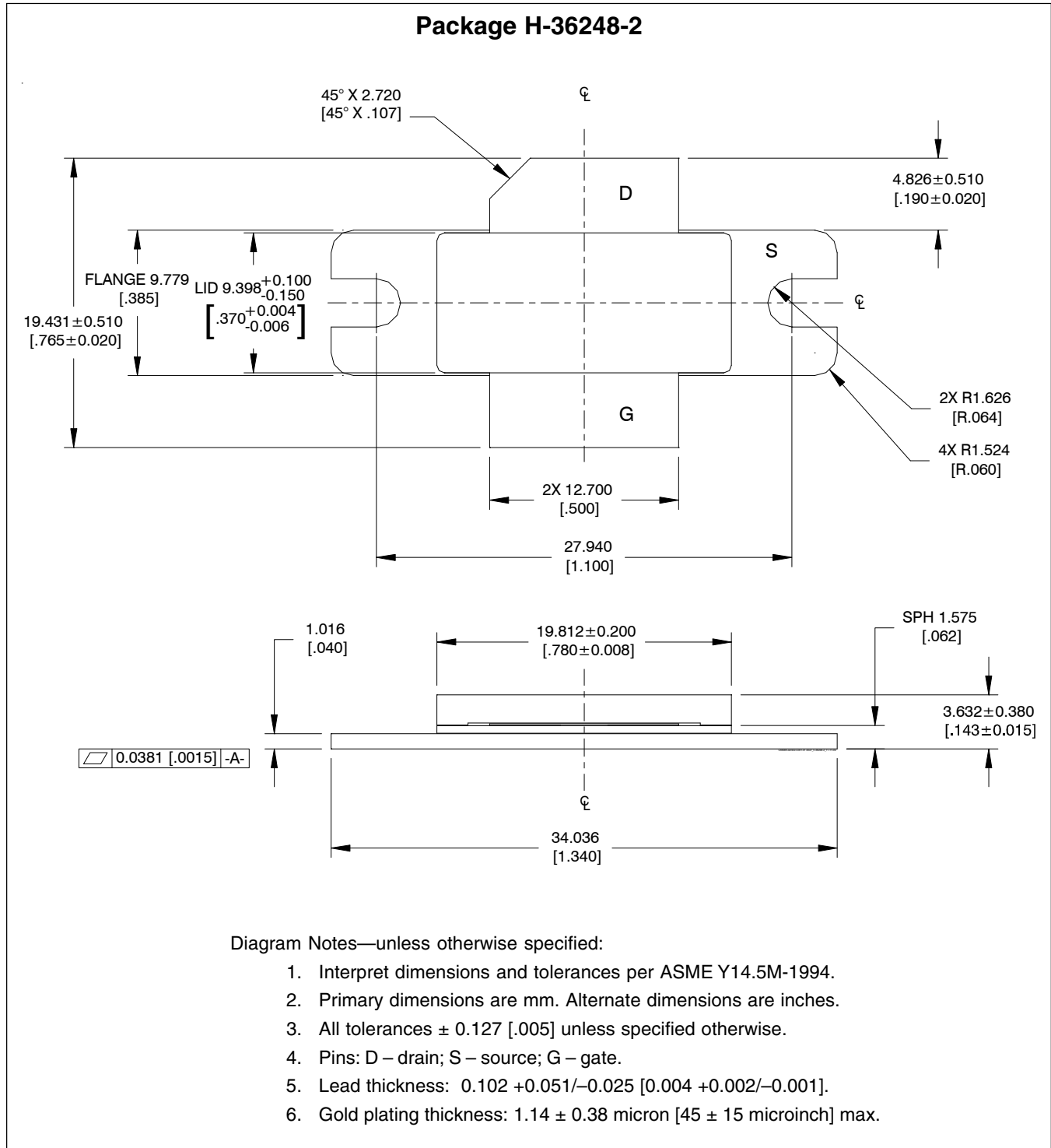

Package Outline Specifications (cont.)

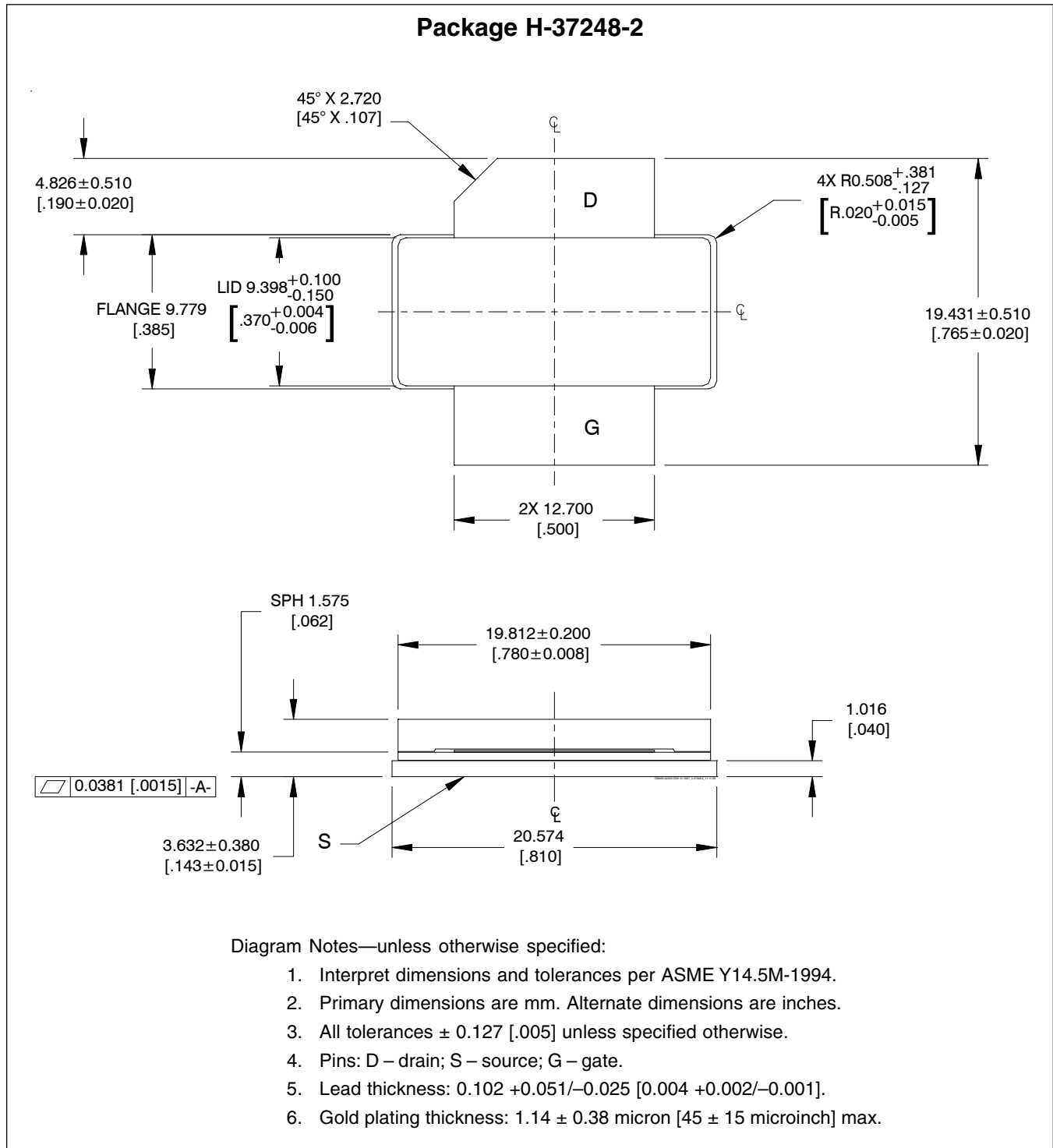

Find the latest and most complete information about products and packaging at the Infineon Internet page  
<http://www.infineon.com/rfpower>

Revision History: 2016-06-14

Data Sheet

Previous Version: 2012-10-15, Data Sheet

Page	Subjects (major changes since last revision)
2	updated ordering information to include R0

**We Listen to Your Comments**

Any information within this document that you feel is wrong, unclear or missing at all?

Your feedback will help us to continuously improve the quality of this document.

Please send your proposal (including a reference to this document) to:

[highpowerRF@infineon.com](mailto:highpowerRF@infineon.com)

To request other information, contact us at:

+1 877 465 3667 (1-877-GO-LDMOS) USA

or +1 408 776 0600 International

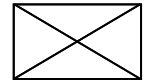

Edition 2016-06-14

Published by

Infineon Technologies AG

81726 Munich, Germany

© 2009 Infineon Technologies AG

All Rights Reserved.

**Legal Disclaimer**

The information given in this document shall in no event be regarded as a guarantee of conditions or characteristics. With respect to any examples or hints given herein, any typical values stated herein and/or any information regarding the application of the device, Infineon Technologies hereby disclaims any and all warranties and liabilities of any kind, including without limitation, warranties of non-infringement of intellectual property rights of any third party.

**Information**

For further information on technology, delivery terms and conditions and prices, please contact the nearest Infineon Technologies Office ([www.infineon.com/rfpower](http://www.infineon.com/rfpower)).

**Warnings**

Due to technical requirements, components may contain dangerous substances. For information on the types in question, please contact the nearest Infineon Technologies Office.

Infineon Technologies components may be used in life-support devices or systems only with the express written approval of Infineon Technologies, if a failure of such components can reasonably be expected to cause the failure of that life-support device or system or to affect the safety or effectiveness of that device or system. Life support devices or systems are intended to be implanted in the human body or to support and/or maintain and sustain and/or protect human life. If they fail, it is reasonable to assume that the health of the user or other persons may be endangered.