

NEW Product

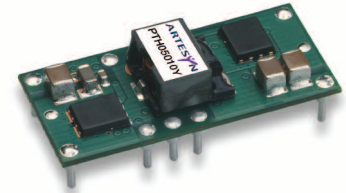

- V_{TT} bus termination output (output the system V_{REF})
- 15 A output current
- 3.3 Vdc, 5 Vdc or 12 Vdc input voltage
- DDR and QDR compatible
- ON/OFF inhibit (for V_{TT} standby)
- Under-voltage lockout
- Operating temperature range: -40 °C to +85 °C
- Efficiencies up to 91%
- Output overcurrent protection (non-latching, auto-reset)
- Point-of-Load-Alliance (POLA) compatible
- Available RoHS compliant



The PTHxx010Y are a new series of non-isolated dc-dc converters designed specifically for bus termination in DDR and QDR memory applications. Operating from either a 3.3 Vdc, 5 Vdc or 12 Vdc input, the modules generate a V_{TT} output that will source or sink up to 15 A of current to accurately track their V_{REF} input. V_{TT} is the required bus termination supply voltage, and V_{REF} is the reference voltage for the memory and chipset bus receiver comparators. V_{REF} is usually set to half the V_{DDQ} power supply voltage. The PTHxx010Y series employs an actively switched synchronous rectifier output to provide state of the art stepdown switching conversion. The products are small in size and are an ideal choice where space, performance and high efficiency are desired.



2 YEAR WARRANTY

All specifications are typical at nominal input, $V_{REF} = 1.25$ V, full load at 25 °C
Unless otherwise stated. C_{in} , C_{o1} and C_{o2} = typical value

SPECIFICATIONS

OUTPUT SPECIFICATIONS

Output current (over V_{REF} range) (See Note 1)	PTH03010Y and PTH05010Y PTH12010Y	± 15 A ± 12 A
Tracking range for V_{REF}	0.55-1.8 Vdc	
Tracking tolerance to V_{REF} ($V_{TT} - V_{REF}$) (over line, load and temperature)	-10 mV to +10 mV	
Ripple and noise	20 MHz bandwidth	20 mV pk-pk
Load transient response (See Note 4)	30 μ s settling time Overshoot/undershoot 30 mV typ.	
Output capacitance:		
Non-ceramic values (See Notes 4 and 5)	PTH03010Y 470 μ F typ., 8,200 μ F max. PTH05010Y 470 μ F typ., 8,200 μ F max. PTH12010Y 940 μ F typ., 6,600 μ F max.	
Ceramic values (See Notes 4)	PTH03010Y 200 μ F typ., 300 μ F max. PTH05010Y 200 μ F typ., 300 μ F max. PTH12010Y 400 μ F typ., 600 μ F max.	
(See Note 6)	ESR (non-ceramic)	4 m Ω min.

INPUT SPECIFICATIONS

Input current	No load	10 mA
Input voltage range	PTH03010Y PTH05010Y PTH12010Y	2.95-3.65 Vdc 4.5-5.5 Vdc 10.8-13.2 Vdc
Undervoltage lockout:		
PTH03010Y	V_{in} increasing V_{in} decreasing	2.45 V typ., 2.80 V max. 2.20 V min., 2.40 V typ.
PTH05010Y	V_{in} increasing V_{in} decreasing	4.30 V typ., 4.45 V max. 3.40 V min., 3.70 V typ.
PTH12010Y	V_{in} increasing V_{in} decreasing	9.5 V typ., 10.4 V max. 8.80 V min., 9.0 V typ.

INPUT SPECIFICATIONS CONTD.

Input capacitance (See Note 3)	PTH03010Y and PTH05010Y PTH12010Y	470 μ F 560 μ F
Remote ON/OFF	Positive logic	

GENERAL SPECIFICATIONS

Efficiency $I_o = 10$ A	PTH03010Y PTH05010Y PTH12010Y	88% typ. 88% typ. 85% typ.
Insulation voltage	Non-isolated	
Switching frequency	PTH03010Y PTH05010Y PTH12010Y	300-400 kHz 300-400 kHz 200-300 kHz
Approvals and standards (pending)	EN60950 UL/cUL60950	
Material flammability	UL94V-0	
Dimensions	(L x W x H)	34.80 x 15.75 x 9.00 mm 1.370 x 0.620 x 0.354 in
Weight	3.7 g (0.13 oz)	
MTBF	Telcordia SR-332	6,000,000 hours

ENVIRONMENTAL SPECIFICATIONS

Thermal performance (See Note 2)	Operating ambient, temperature Non-operating	-40 °C to +85 °C -40 °C to +125 °C
MSL ('Z' suffix only)	JEDEC J-STD-020C	Level 3

PROTECTION

Overcurrent threshold (Auto reset)	PTH03010Y and PTH05010Y PTH12010Y	27.5 A typ. 20.0 A typ.
------------------------------------	--------------------------------------	----------------------------

OUTPUT POWER (MAX.)	INPUT VOLTAGE	V _{TT} RANGE	OUTPUT CURRENT (MIN.)	OUTPUT CURRENT (MAX.)	EFFICIENCY (TYP.)	MODEL NUMBER ^(8,9)
27 W	2.95-3.65 Vdc	0.55-1.8 Vdc	0 A	±15 A	88%	PTH03010Y
27 W	4.5-5.5 Vdc	0.55-1.8 Vdc	0 A	±15 A	88%	PTH05010Y
21.6 W	10.8-13.2 Vdc	0.55-1.8 Vdc	0 A	±12 A	85%	PTH12010Y

Part Number System with Options

PTH05010YAST

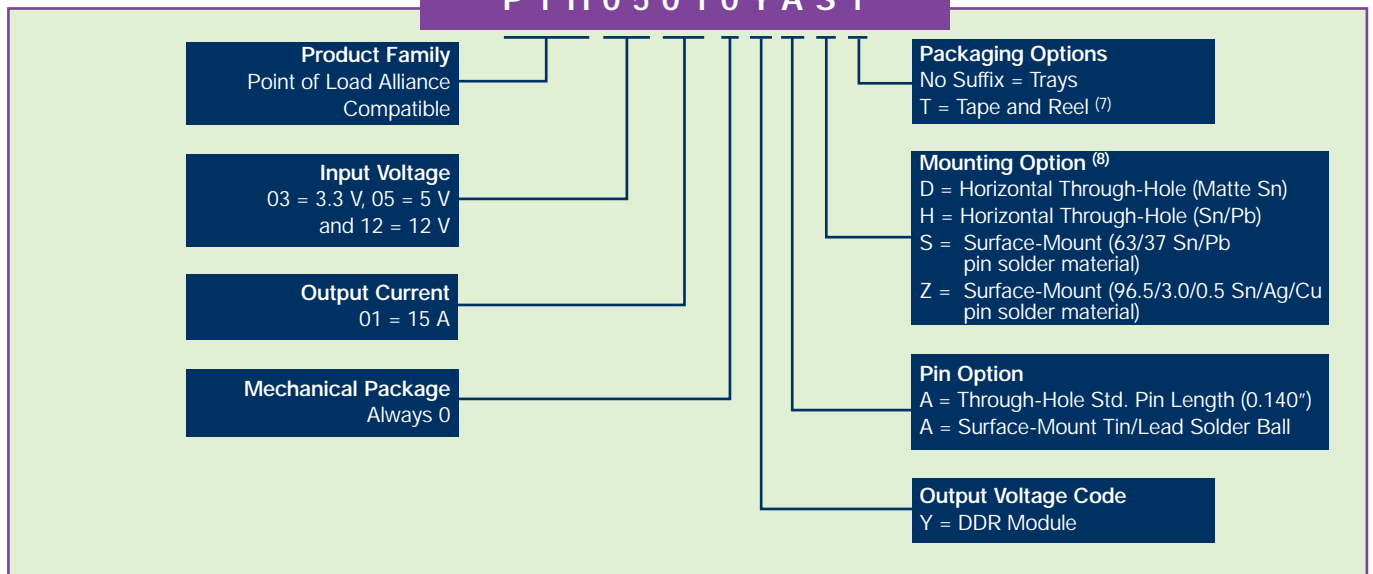

Notes

- Rating is conditional on the module being soldered to a 4 layer PCB with 1 oz. copper. See the SOA curves or contact the factory for appropriate derating.
- This control pin has an internal pull-up to the input voltage V_{in} . If it is left open-circuit the module will operate when input power is applied. A small low-leakage (<100 nA) MOSFET is recommended for control. For further information, consult Application Note 177.
- An input capacitor is required for proper operation. The capacitor must be rated for a minimum of 800 mA rms of ripple current.
- The typical value of external output capacitance value ensures that V_{TT} meets the specified transient performance requirements for the memory bus terminations. Lower values of capacitance may be possible when the measured peak change in output current is consistently less than 3 A. Test conditions were 15 A/μs load step, -1.5 A to +1.5 A.
- This is the calculated maximum. The minimum ESR limitation will often result in a lower value. Consult Application Note 177 for further details.
- This is the typical ESR for all the electrolytic (non-ceramic) output capacitance. Use 7 mΩ as the minimum when using max-ESR values to calculate.
- Tape and reel packaging only available on the surface-mount versions.
- To order Pb-free (RoHS compatible) surface-mount parts replace the mounting option 'S' with 'Z', e.g. PTHXX010YAZ. To order Pb-free (RoHS compatible) through-hole parts replace the mounting option 'H' with 'D', e.g. PTHXX010YAD.
- NOTICE: Some models do not support all options. Please contact your local Artesyn representative or use the on-line model number search tool at <http://www.artesyn.com/powergroup/products.htm> to find a suitable alternative.

International Safety Standard Approvals



UL/cUL CAN/CSA-C22.2 No. 60950
File No. E174104



TÜV Product Service (EN60950) Certificate No. B 04 06 38572 044
CB Report and Certificate to IEC60950, Certificate No. US/8292/UL

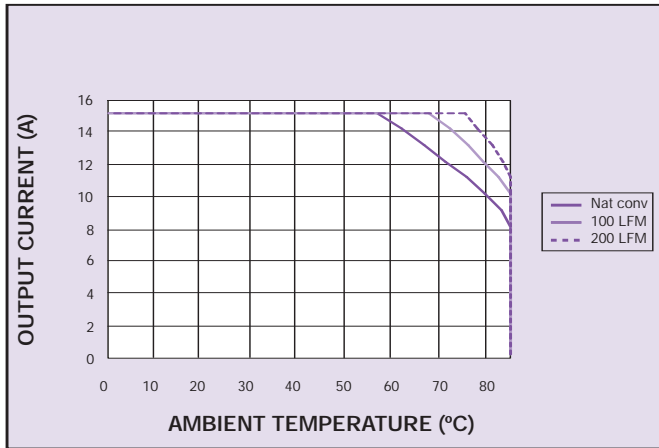

Figure 1 - Safe Operating Area
Vin = 3.3 V, VREF = 1.25 V, Iout = 15 A (See Note A)

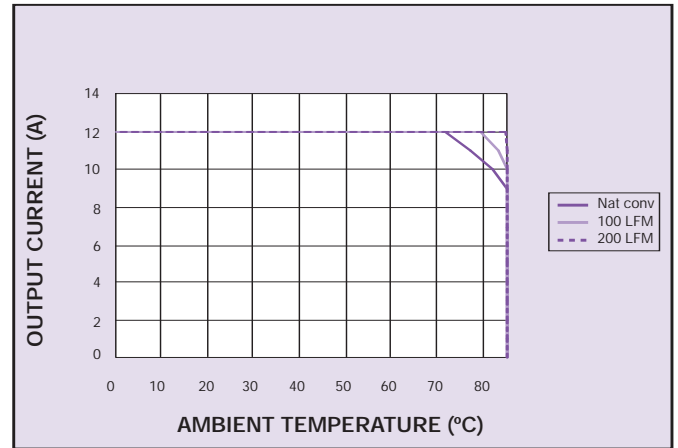

Figure 2 - Safe Operating Area
Vin = 12 V, VREF = 1.25 V, Iout = 12 A (See Note A)

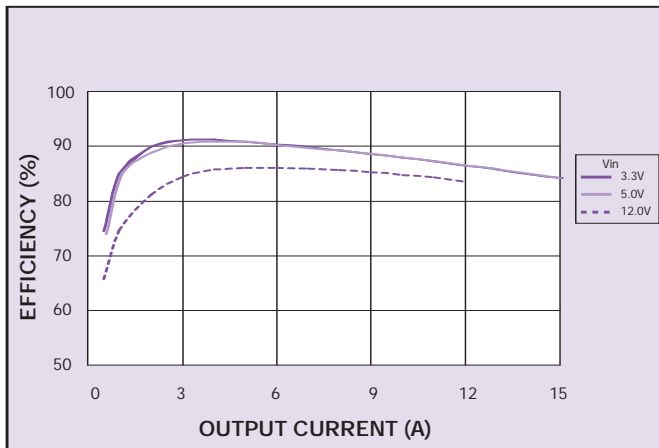

Figure 3 - Efficiency vs Load Current
VREF = 1.25 V (See Note B)

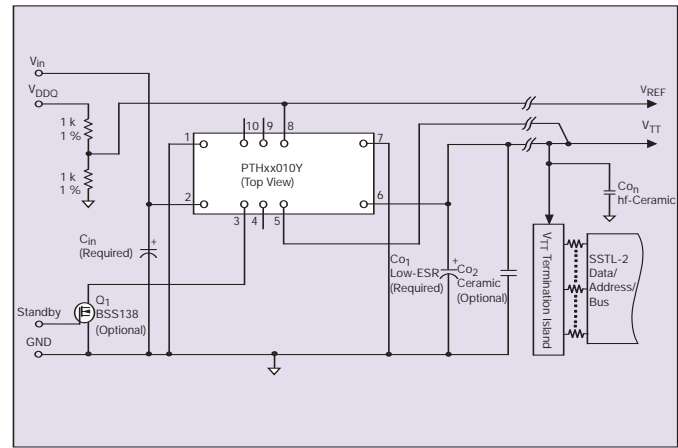

Figure 4 - Standard Application

Notes

- A The SOA curves represent the conditions at which internal components are within the Artesyn derating guidelines.
- B Characteristic data has been developed from actual products tested at 25 °C. This data is considered typical data for the converter.

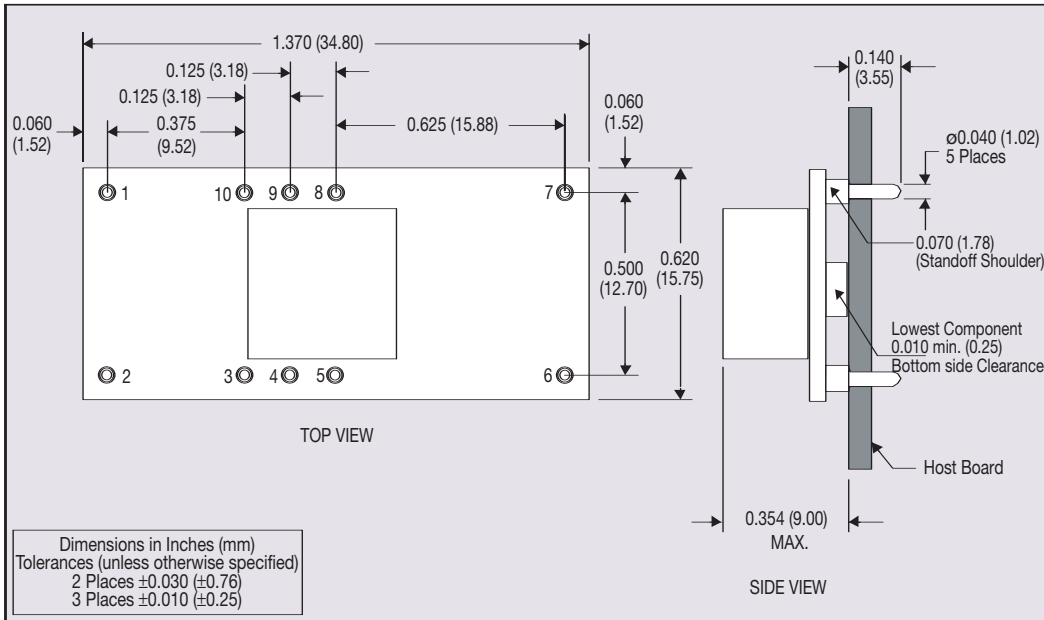

Figure 5 - Plated Through-Hole Mechanical Drawing

PIN CONNECTIONS	
PIN NO.	FUNCTION
1	Ground
2	Vin
3	Inhibit*
4	N/C
5	Vo sense
6	V _{TT}
7	Ground
8	V _{REF}
9	N/C
10	N/C

*Denotes negative logic:
Open = Normal operation
Ground = Function active

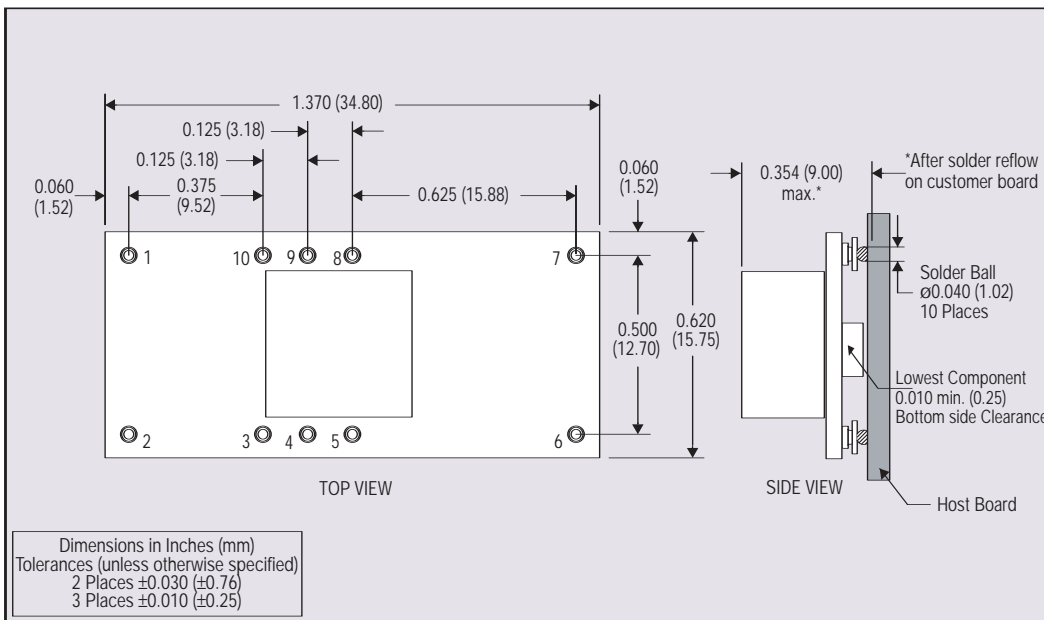

Figure 6 - Surface-Mount Mechanical Drawing