

CIRCUIT

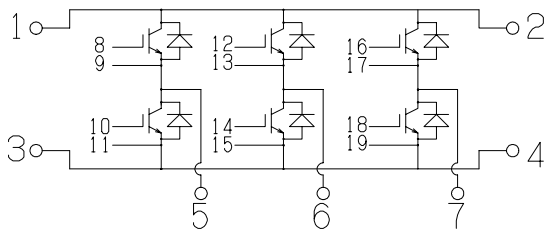

OUTLINE DRAWING

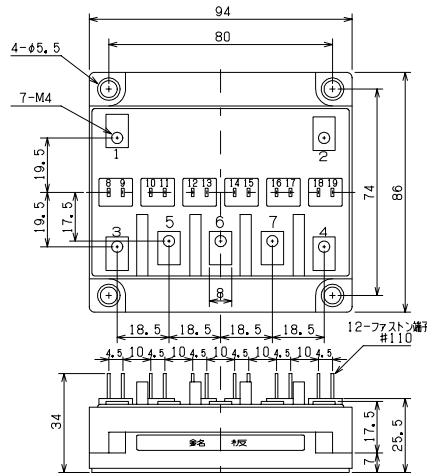

12- fastener- tab No 110

Dimension(mm)

Approximate Weight : 550g

MAXMUM RATINGS (Tc=25°C)

Item	Symbol	PTMB100A6	Unit
Collector-Emitter Voltage	V _{CES}	600	V
Gate - Emitter Voltage	V _{GES}	+/- 20	V
Collector Current	DC	I _C 100	A
	1 ms	I _{CP} 200	
Collector Power Dissipation	P _C	400	W
Junction Temperature Range	T _j	-40 to +150	°C
Storage Temperature Range	T _{stg}	-40 to +125	°C
Isolation Voltage Terminal to Base AC, 1 min.)	V _{ISO}	2500	V
Mounting Torque	Module Base to Heatsink	F _{TOR} 2	N•m
	Bus Bar to Main Terminals	1.4	

ELECTRICAL CHARACTERISTICS (Tc=25°C)

Characteristic	Symbol	Test Condition	Min.	Typ.	Max.	Unit
Collector-Emitter Cut-Off Current	I _{CES}	V _{CE} =600V, V _{GE} =0V	-	-	1.0	mA
Gate-Emitter Leakage Current	I _{GES}	V _{GE} =+/- 20V, V _{CE} =0V	-	-	1.0	μA
Collector-Emitter Saturation Voltage	V _{CE(sat)}	I _C =100A, V _{GE} =15V	-	2.1	2.6	V
Gate-Emitter Threshold Voltage	V _{GE(th)}	V _{CE} =5V, I _C =100mA	4.0	-	8.0	V
Input Capacitance	C _{ies}	V _{CE} =10V, V _{GE} =0V, f=1MHz	-	10000	-	pF
Switching Time	Rise Time	V _{CC} = 300V R _L = 3 ohm R _G = 7.5 ohm V _{GE} = +/- 15V	-	0.15	0.3	μs
	Turn-on Time		-	0.25	0.4	
	Fall Time		-	0.2	0.35	
	Turn-off Time		-	0.45	0.7	

FREE WHEELING DIODES RATINGS & CHARACTERISTICS (Tc=25°C)

Item	Symbol	Rated Value	Unit
Forward Current	DC	I _F 100	A
	1 ms	I _{FM} 200	

Characteristic	Symbol	Test Condition	Min.	Typ.	Max.	Unit
Peak Forward Voltage	V _F	I _F =100A, V _{GE} =0V	-	1.9	2.4	V
Reverse Recovery Time	t _{rr}	I _F =100A, V _{GE} =-10V, di/dt=100A/μs	-	0.15	0.25	μs

THERMAL CHARACTERISTICS

Characteristic	Symbol	Test Condition	Min.	Typ.	Max.	Unit
Thermal Impedance	IGBT	Junction to Case	-	-	0.31	°C/W
	DIODE		-	-	0.65	

PTMB100A6

Fig.1- Output Characteristics (Typical)

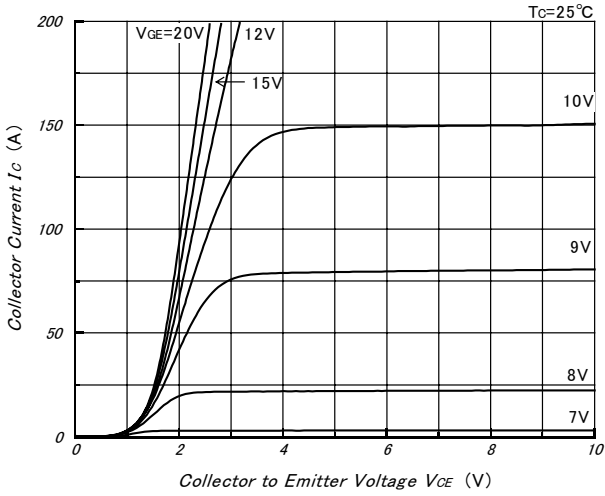

Fig.2- Collector to Emitter On Voltage vs. Gate to Emitter Voltage (Typical)

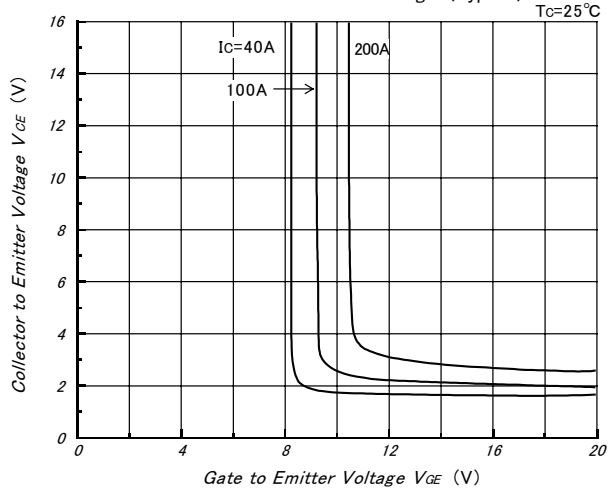

Fig.3- Collector to Emitter On Voltage vs. Gate to Emitter Voltage (Typical)

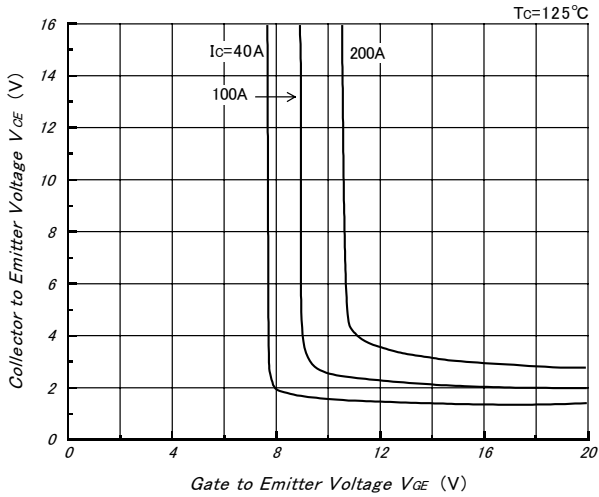

Fig.4- Gate Charge vs. Collector to Emitter Voltage (Typical)

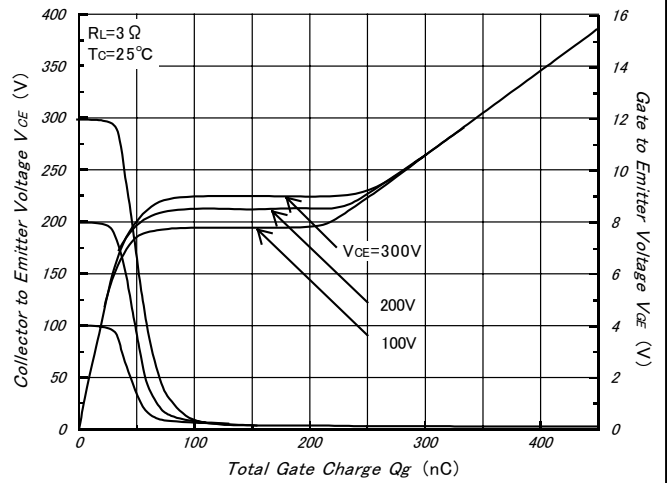

Fig.5- Capacitance vs. Collector to Emitter Voltage (Typical)

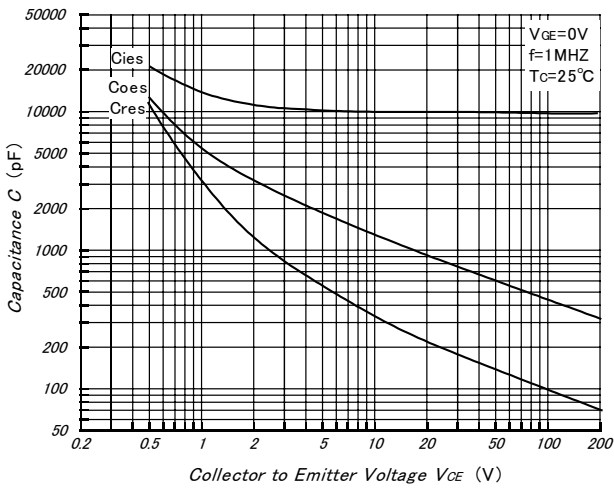
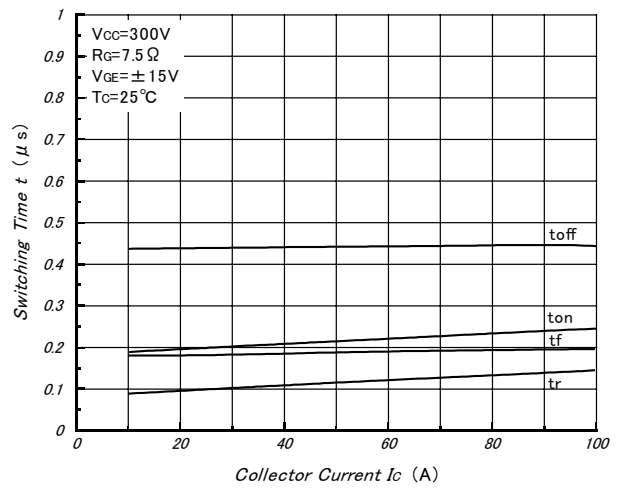

Fig.6- Collector Current vs. Switching Time (Typical)



PTMB100A6

Fig.7- Series Gate Impedance vs. Switching Time (Typical)

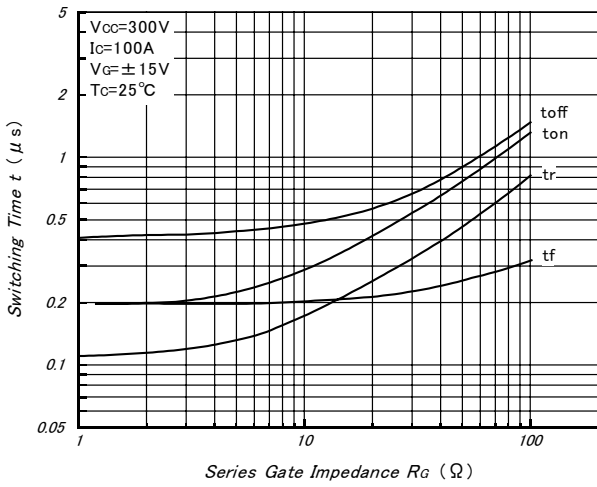

Fig.8- Forward Characteristics of Free Wheeling Diode (Typical)

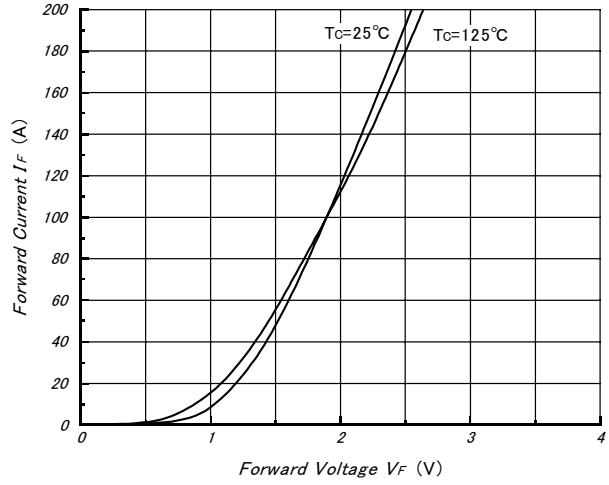

Fig.9- Reverse Recovery Characteristics (Typical)

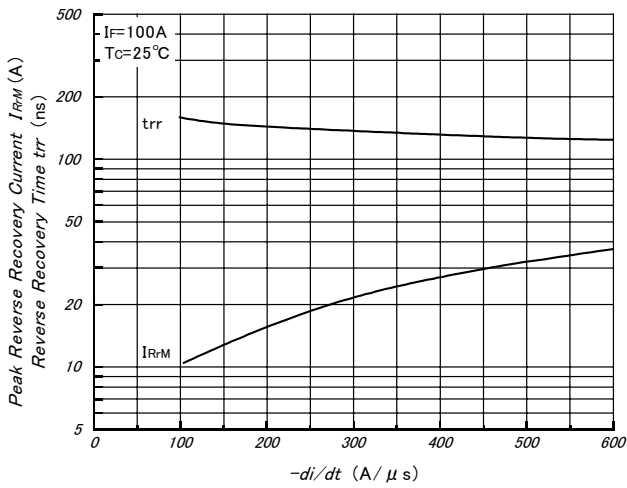

Fig.10- Reverse Bias Safe Operating Area (Typical)

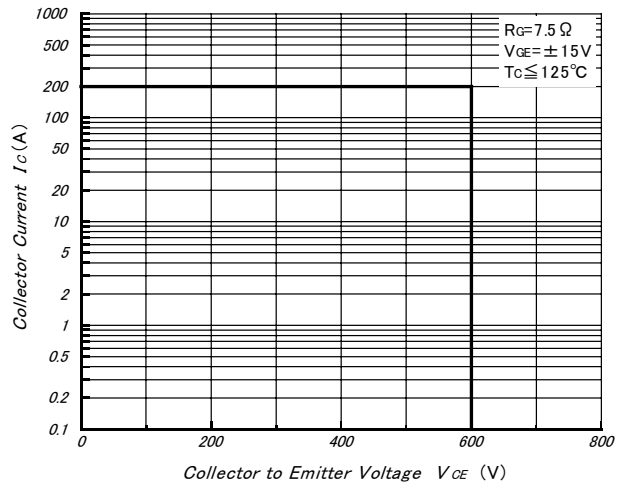

Fig.11- Transient Thermal Impedance

