

PTS1206

6-60 Volt DC surface mount resettable PTC devices

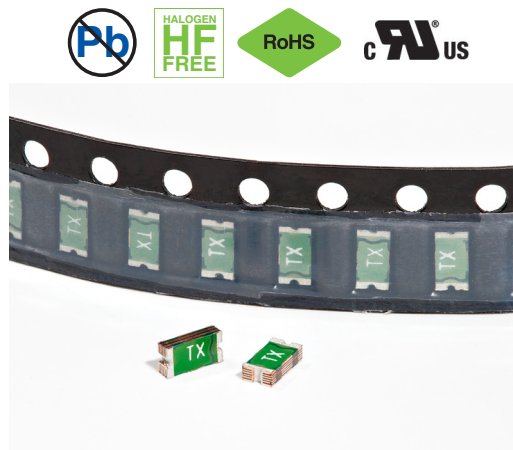

Applications

- USB peripherals
- Plug and play protection for motherboards and peripherals
- Power tools
- Battery and port protection for mobile/smart phones
- Game console port protection
- Set-top-boxes
- Tablets, notebooks, netbooks, laptops and desktops
- Rechargeable battery packs
- Digital cameras
- Appliances and white goods
- Consumer electronics

Product description

- Positive Temperature Coefficient (PTC)
- SMT resettable device
- Low resistance
- Fast time-to-trip
- Current range from 0.05A to 2.0A
- 1206 (3216 metric) compact footprint
- Halogen free, lead free, RoHS compliant

Agency information

- cURus Recognition file number: E343021
- TUV: R50192872

Product specifications

Part Number ⁷	V _{max} ¹	I _{max} ²	I _{hold} ³	I _{trip} ⁴	P _d ⁵	Time to trip (maximum)		Resistance ⁶		Agency information		
	(V _{DC})	(A)	(A)	(A)	typical (W)	(A)	(Seconds)	Initial (R _i) minimum (Ω)	Post trip (R _p) maximum (Ω)	Part marking	cURus	TUV
PTS120660V005	60	100	0.05	0.15	0.4	0.25	1.5	3.6	50	TH	x	x
PTS120660V010	60	100	0.10	0.25	0.4	0.5	1.0	1.6	15	TY	x	x
PTS120630V012	30	100	0.12	0.29	0.5	1	0.2	1.4	6	TJ	x	x
PTS120630V016	30	100	0.16	0.37	0.5	1	0.3	1.1	4.5	TK	x	x
PTS120624V020	24	100	0.20	0.42	0.6	8	0.1	0.65	2.6	TL	x	x
PTS120616V025	16	100	0.25	0.50	0.6	8	0.08	0.55	2.3	TN	x	x
PTS120616V035	16	100	0.35	0.75	0.6	8	0.1	0.3	1.2	TP	x	x
PTS12066V050	6	100	0.50	1.0	0.6	8	0.1	0.15	0.7	TQ	x	x
PTS120615V050	15	100	0.50	1.0	0.6	8	0.1	0.15	0.7	TQ1	x	x
PTS12066V075	6	100	0.75	1.5	0.6	8	0.2	0.1	0.29	TR	x	x
PTS12066V100	6	100	1.0	1.8	0.8	8	0.3	0.065	0.21	TS	x	x
PTS12066V110	6	100	1.1	2.2	0.8	8	0.3	0.07	0.2	TU	x	x
PTS12066V150	6	100	1.5	3.0	0.8	8	1	0.04	0.12	TV	x	x
PTS12066V200	6	100	2.0	3.5	1.0	8	1.5	0.02	0.08	TX	x	x

1. V_{max}: Maximum continuous voltage the device can withstand without damage at current
2. I_{max}: Maximum fault current the device can withstand without damage at rated voltage
3. I_{hold}: Maximum current the device will pass without interruption at 23°C still air
4. I_{trip}: Minimum current that will transition the device from low resistance to high resistance at 23°C still air
5. P_d: Power dissipated from the device when in tripped state at 23°C still air

6. R_i: Minimum resistance of the device at 23°C
R_p: Maximum resistance of the device when measured one hour post reflow at 23°C
7. Part Number Definition: PTS1206xVxxx
PTS1206 = Product code and size
xV = Voltage rating (V_{max})
xxx = Ampere rating (I_{hold})

Dimensions—mm (in)

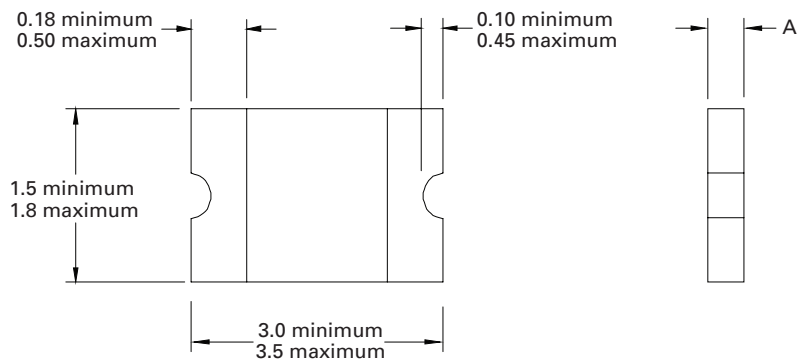

Part number	A minimum	A maximum
PTS120660V005	0.50	0.90
PTS120660V010	0.50	0.90
PTS120630V012	0.35	0.90
PTS120630V016	0.28	0.68
PTS120624V020	0.28	0.68
PTS120616V025	0.28	0.68
PTS120616V035	0.28	0.68
PTS12066V050	0.28	0.68
PTS120615V050	0.28	1.06
PTS12066V075	0.28	0.85
PTS12066V100	0.40	0.88
PTS12066V110	0.40	0.88
PTS12066V150	0.55	1.15
PTS12066V200	0.55	1.15

Recommended pad layout—mm (in)

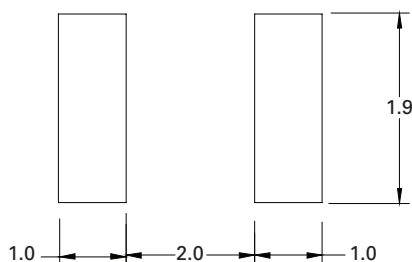

Time to trip curves at 23°C

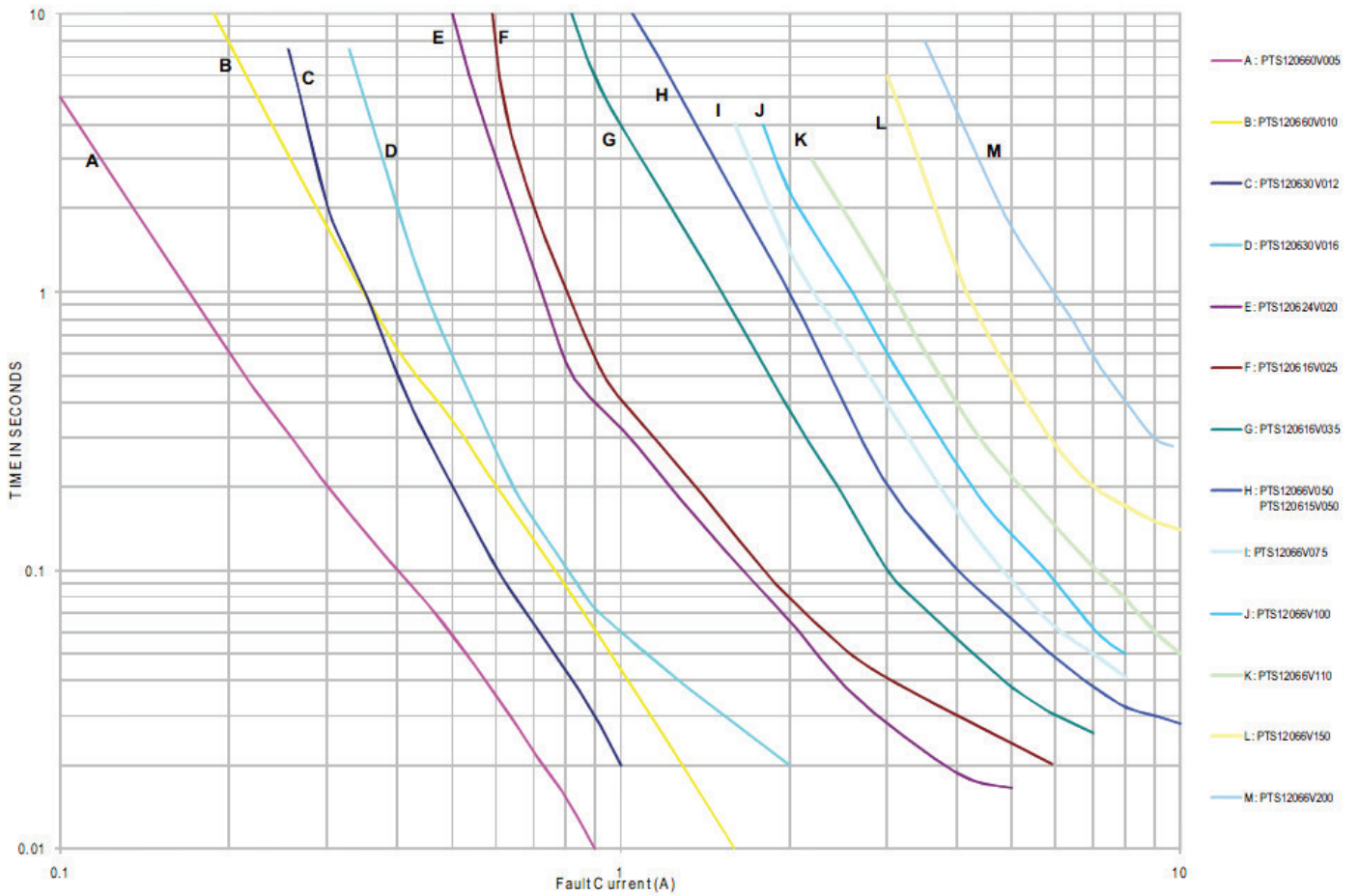

Temperature derating curve

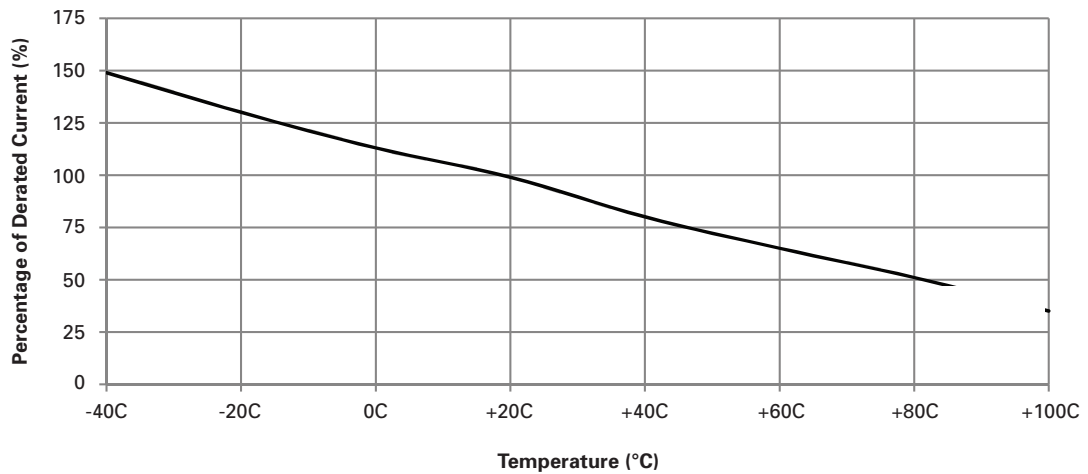

Environmental data

Operating temperature: -40°C to +85°C (with derating)
Storage temperature: -10°C to +40°C
Storage relative humidity: 75%
Storage condition: Keep away from corrosive atmosphere and sunlight
Storage duration: 1 year
Thermal shock: (20 cycles - 40°C to +85°C) -33% typical resistance change
Humidity: +85°C, 85% relative humidity, 1000 hours ±5% typical resistance change
Resistance to solvents: MIL-STD- 202 Method 215

Packaging information-mm

Supplied in tape and reel packaging, 5000 parts per 7.0" diameter reel

PTS120630V012, PTS120630V016, PTS120624V020, PTS120616V025, PTS120616V035, PTS12066V050, PTS12066V075

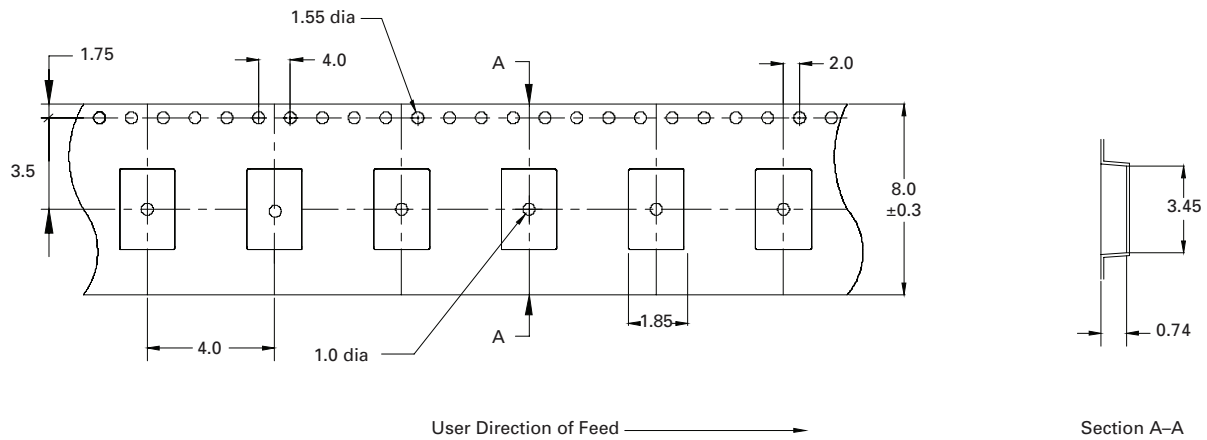

Supplied in tape and reel packaging, 2500 parts per 7.0" diameter reel

PTS120660V005, PTS120660V010, PTS120615V050, PTS12066V100, PTS12066V110, PTS12066V150, PTS12066V200

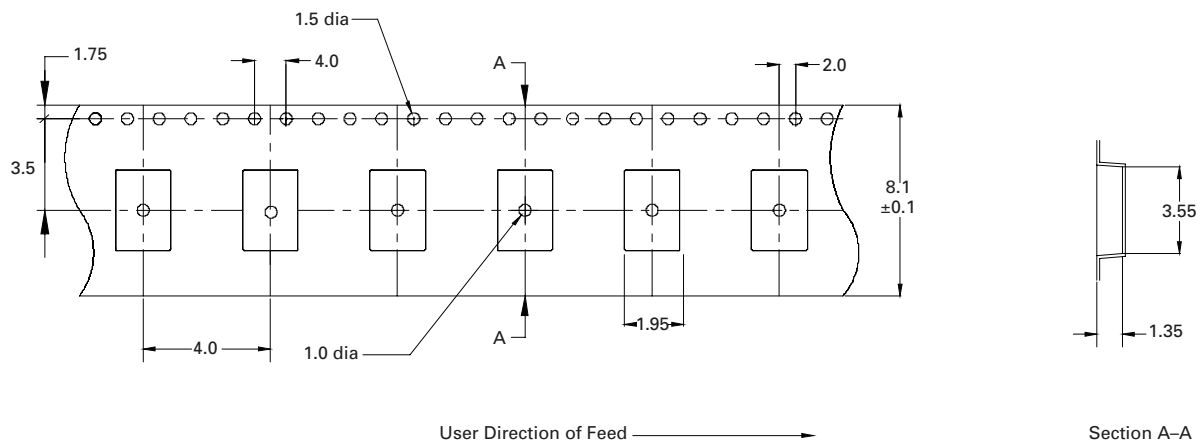

Solder reflow profile

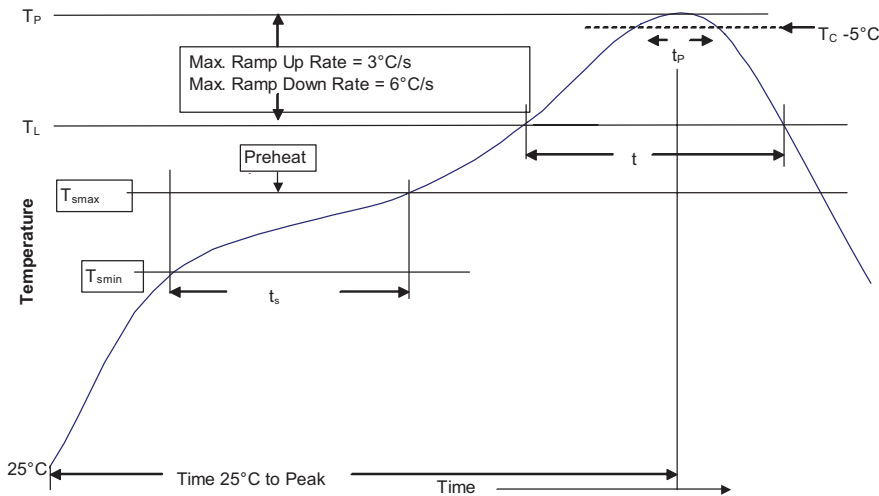

Table 1 - Standard SnPb Solder (T_C)

Package Thickness	Volume mm ³ <350	Volume mm ³ ≥350
<2.5mm)	235°C	220°C
≥2.5mm	220°C	220°C

Table 2 - Lead (Pb) Free Solder (T_C)

Package Thickness	Volume mm ³ <350	Volume mm ³ 350 - 2000	Volume mm ³ >2000
<1.6mm	260°C	260°C	260°C
1.6 - 2.5mm	260°C	250°C	245°C
>2.5mm	250°C	245°C	245°C

Reference JDEC J-STD-020D

Profile Feature	Standard SnPb Solder	Lead (Pb) Free Solder
Preheat and Soak		
• Temperature min. (T_{smin})	100°C	150°C
• Temperature max. (T_{smax})	150°C	200°C
• Time (T_{smin} to T_{smax}) (t_s)	60-120 Seconds	60-120 Seconds
Average ramp up rate T_{smax} to T_p	3°C/ Second Max.	3°C/ Second Max.
Liquidous temperature (T_L)	183°C	217°C
Time at liquidous (t_L)	60-150 Seconds	60-150 Seconds
Peak package body temperature (T_p)*	Table 1	Table 2
Time (t_p)** within 5 °C of the specified classification temperature (T_C)	20 Seconds**	30 Seconds**
Average ramp-down rate (T_p to T_{smax})	6°C/ Second Max.	6°C/ Second Max.
Time 25°C to Peak Temperature	6 Minutes Max.	8 Minutes Max.

* Tolerance for peak profile temperature (T_p) is defined as a supplier minimum and a user maximum.
** Tolerance for time at peak profile temperature (t_p) is defined as a supplier minimum and a user maximum.

Wave solder

Reservoir temperature: 260°C
Time in reservoir: 10 seconds maximum

Life Support Policy: Eaton does not authorize the use of any of its products for use in life support devices or systems without the express written approval of an officer of the Company. Life support systems are devices which support or sustain life, and whose failure to perform, when properly used in accordance with instructions for use provided in the labeling, can be reasonably expected to result in significant injury to the user.

Eaton reserves the right, without notice, to change design or construction of any products and to discontinue or limit distribution of any products. Eaton also reserves the right to change or update, without notice, any technical information contained in this bulletin.

Eaton
Electronics Division
1000 Eaton Boulevard
Cleveland, OH 44122
United States
www.eaton.com/elx

© 2015 Eaton
All Rights Reserved
Printed in USA
Publication No. 4397 BU-MC15016
October 2015

Eaton is a registered trademark.
All other trademarks are property of their respective owners.