

Thermally-Enhanced High Power RF LDMOS FET 250 W, 50 V, 470 – 806 MHz

Description

The PTVA042502EC and PTVA042502FC LDMOS FETs are designed for use in power amplifier applications in the 470 MHz to 806 MHz frequency band. Features include high gain and thermally-enhanced package with bolt-down or earless flanges. Manufactured with Infineon's advanced LDMOS process, these devices provide excellent thermal performance and superior reliability.

PTVA042502EC
Package H-36248-4



PTVA042502FC
Package H-37248-4

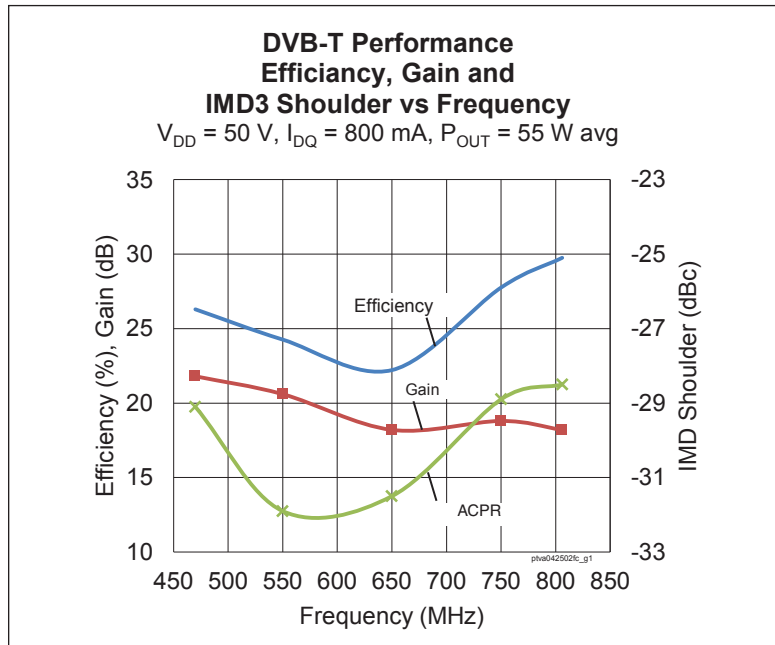

Features

- Input matched
- Integrated ESD protection
- Human Body Model Class 1C (per ANSI/ESDA/JEDEC JS-001)
- Low thermal resistance
- RoHS compliant
- Capable of withstanding a 10:1 VSWR at 55W average power under DVB-T signal condition

RF Characteristics

DVB-T (8K OFDM, 64QAM) Characteristics (tested in Infineon test fixture)

$V_{DD} = 50\text{ V}$, $I_{DQ} = 800\text{ mA}$, $f = 806\text{ MHz}$, input PAR = 10.5 dB (unclipped), output PAR = 7.8 dB @ 0.01% CCDF probability

Characteristic	Symbol	Min	Typ	Max	Unit
Average Output Power	P_{OUT}	—	55	—	W
Gain	G_{ps}	17.5	19	—	dB
Drain Efficiency	η_D	23	25.5	—	%
Adjacent Channel Power Ratio (ACPR integrated over 200 KHz BW at + 4.3 MHz offset from center frequency)	ACPR	—	-29.5	-25	dBc

All published data at $T_{CASE} = 25^\circ\text{C}$ unless otherwise indicated

ESD: Electrostatic discharge sensitive device—observe handling precautions!

DC Characteristics

Characteristic	Conditions	Symbol	Min	Typ	Max	Unit
Drain-Source Breakdown Voltage	$V_{GS} = 0\text{ V}, I_{DS} = 10\text{ mA}$	$V_{(BR)DSS}$	105	—	—	V
Drain Leakage Current	$V_{DS} = 50\text{ V}, V_{GS} = 0\text{ V}$	I_{DSS}	—	—	1.0	μA
	$V_{DS} = 105\text{ V}, V_{GS} = 0\text{ V}$	I_{DSS}	—	—	10.0	μA
On-State Resistance	$V_{GS} = 10\text{ V}, V_{DS} = 0.1\text{ V}$	$R_{DS(on)}$	—	0.1	—	Ω
Operating Gate Voltage	$V_{DS} = 50\text{ V}, I_{DQ} = 800\text{ mA}$	V_{GS}	3.0	3.7	4.0	V
Gate Leakage Current	$V_{GS} = 10\text{ V}, V_{DS} = 0\text{ V}$	I_{GSS}	—	—	1.0	μA

Maximum Ratings

Parameter	Symbol	Value	Unit
Drain-Source Voltage	V_{DSS}	105	V
Gate-Source Voltage	V_{GS}	-6 to +12	V
Junction Temperature	T_J	200	$^{\circ}\text{C}$
Storage Temperature Range	T_{STG}	-65 to +150	$^{\circ}\text{C}$
Thermal Resistance ($T_{CASE} = 70^{\circ}\text{C}, 55\text{ W CW}$)	$R_{\theta JC}$	0.4	$^{\circ}\text{C/W}$

Ordering Information

Type and Version	Order Code	Package and Description	Shipping
PTVA042502EC V1 R0	PTVA042502ECV1R0XTMA1	H-36248-4, push-pull, bolt-down	Tape & Reel, 50pcs
PTVA042502EC V1 R250	PTVA042502ECV1R250XTMA1	H-36248-4, push-pull, bolt-down	Tape & Reel, 250pcs
PTVA042502FC V1 R0	PTVA042502FCV1R0XTMA1	H-37248-4, push-pull, earless	Tape & Reel, 50pcs
PTVA042502FC V1 R250	PTVA042502FCV1R250XTMA1	H-37248-4, push-pull, earless	Tape & Reel, 250pcs

Typical Performance

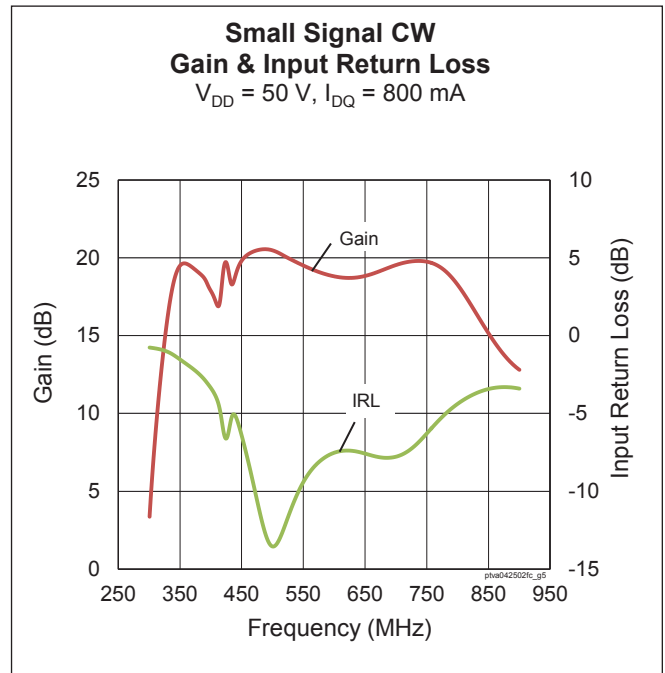
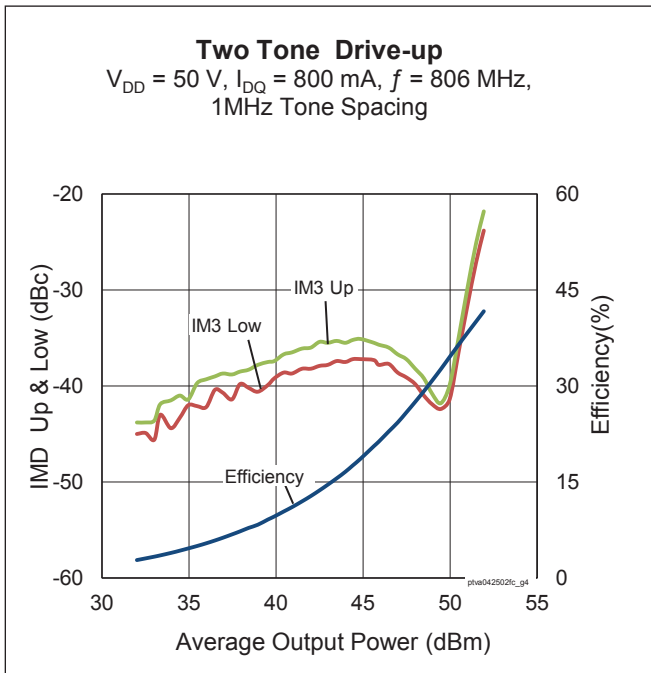
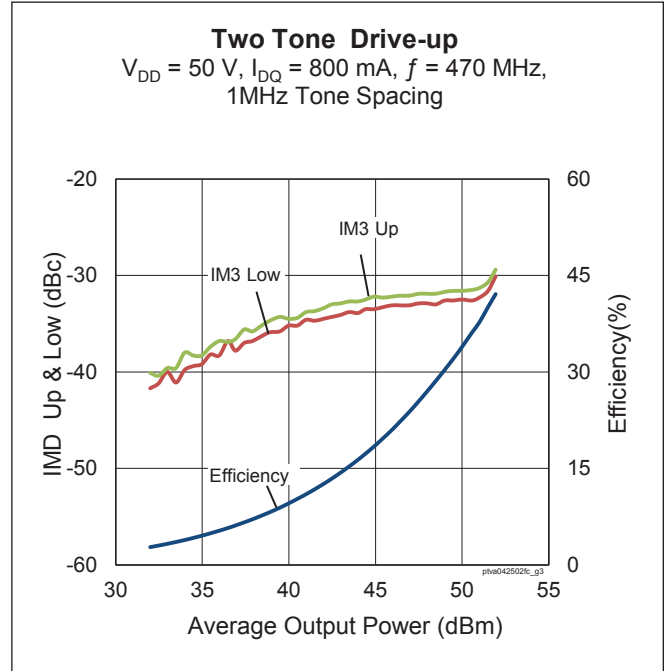
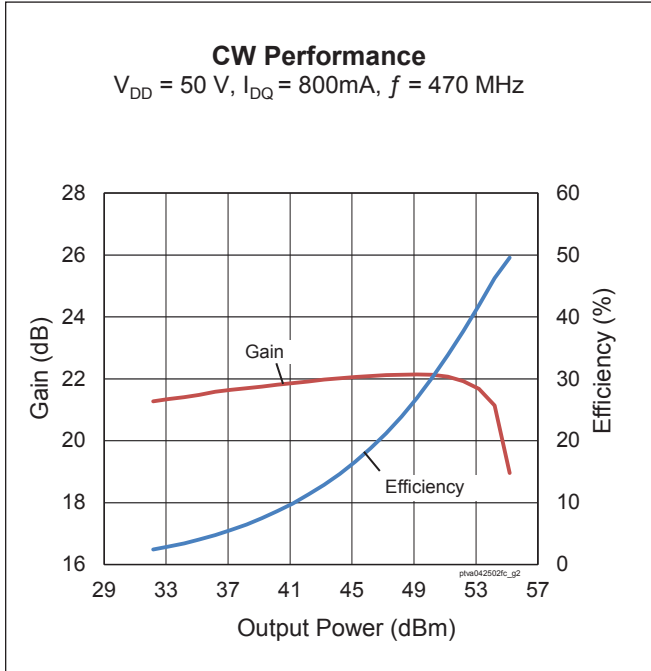

Load Pull Performance

Pulsed CW signal: 16 μ s, 10% duty cycle, 50 V, 100 mA

		P _{1dB}									
		Max Output Power					Max PAE				
Freq [MHz]	Z _s [Ω]	ZI [Ω]	Gain [dB]	P _{OUT} [dBm]	P _{OUT} [W]	PAE [%]	ZI [Ω]	Gain [dB]	P _{OUT} [dBm]	P _{OUT} [W]	PAE [%]
500	0.9 – j1.4	2.9 + j0.8	22.4	54.05	254	71.2	2.5 + j4.5	24.6	50.59	115	79.5
600	0.7 – j2.0	2.2 + j0.8	21.1	52.15	164	61.8	2.2 + j3.6	23.4	49.27	85	76.3
700	1.4 – j2.8	2.1 + j0.8	20.5	52.64	184	59.6	1.9 + j3.4	22.9	49.97	99	75.3
859	3.7 – j4.9	2.0 + j0.2	19.1	52.38	173	62.2	1.8 + j1.9	21.2	50.44	111	74.1

Pulsed CW signal: 16 μ s, 10% duty cycle, 50 V, 100 mA

		P _{3dB}									
		Max Output Power					Max PAE				
Freq [MHz]	Z _s [Ω]	ZI [Ω]	Gain [dB]	P _{OUT} [dBm]	P _{OUT} [W]	PAE [%]	ZI [Ω]	Gain [dB]	P _{OUT} [dBm]	P _{OUT} [W]	PAE [%]
500	0.9 – j1.4	2.9 + j0.6	20.3	54.58	287	74.1	2.6 + j4.1	22.4	51.49	141	80.0
600	0.7 – j2.0	2.3 + j0.7	19.0	52.77	189	62.2	2.3 + j3.2	21.1	50.39	109	76.9
700	1.4 – j2.8	2.2 + j0.7	18.4	53.34	216	60.2	1.8 + j3.2	20.7	50.60	115	75.8
859	3.7 – j4.5	2.0 + j0.1	17.0	53.11	205	63.9	1.8 + j1.8	19.1	51.08	128	73.6

All published data at $T_{CASE} = 25^{\circ}C$ unless otherwise indicated

ESD: Electrostatic discharge sensitive device—observe handling precautions!

Reference Circuit , 470 – 806 MHz

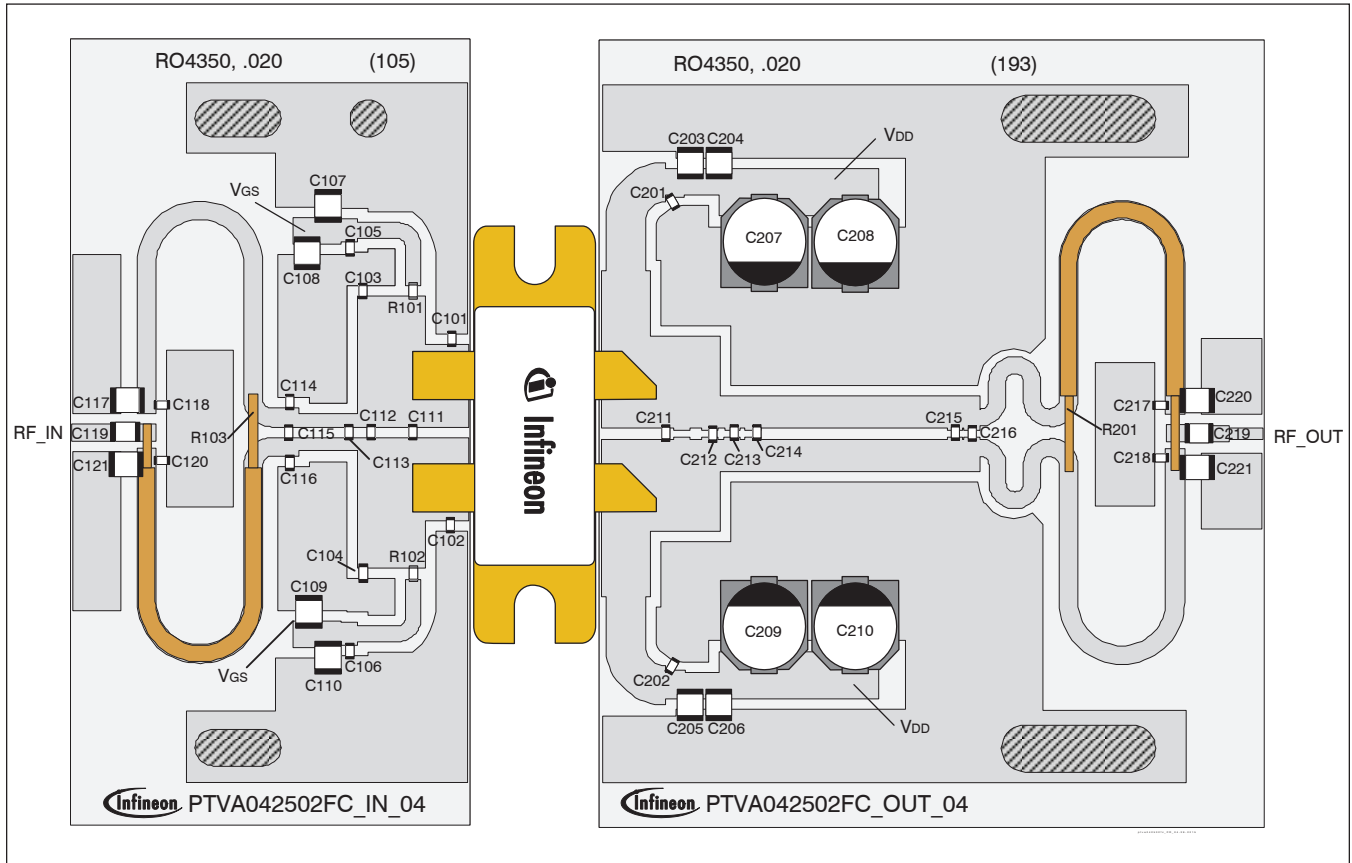

Reference circuit assembly diagram (not to scale)

Reference Circuit (cont.)

Reference Circuit Assembly

DUT	PTVA042502EC or PTVA042502FC
Test Fixture Part No.	LTN/PTVA042502EC V1 or LTN/PTVA042502FC V1
PCB	Rogers 4350, 0.508 mm [0.020"] thick, 2 oz. copper, $\epsilon_r = 3.66$, $f = 470 - 806$ MHz
Find Gerber files for this test fixture on the Infineon Web site at www.infineon.com/rfpower	

Components Information

Component	Description	Manufacturer	P/N
Input			
C101, C102	Capacitor, 20 pF	ATC	ATC100A200JW150XB
C103, C104, C112, C115	Capacitor, 8.2 pF	ATC	ATC100A8R2JW150XB
C105, C106	Capacitor, 120 pF	ATC	ATC700A120KP150XB
C107, C108, C109, C110, C117, C121	Capacitor, 4.7 μ F	Murata Electronics North America	GRM32ER71H475KA88L
C111, C113	Capacitor, 10 pF	ATC	ATC100A100JW150XB
C114, C116	Capacitor, 6.8 pF	ATC	ATC100A6R8JW150XB
C118, C120	Capacitor, 100 pF	ATC	ATC100A101JW150XB
C119	Capacitor, 91 pF	ATC	ATC100A910JW150XB
R101, R102	Resistor, 1K Ω	Panasonic Electronic Components	ERJ-8GEYJ102V
R103	Coax, 25 Ω	AMWAYE	UT-090C-25
Output			
C201, C202	Capacitor, 270 pF	ATC	ATC700A271KP150XB
C203, C204, C205, C206, C220, C221	Capacitor, 4.7 μ F	Murata Electronics North America	GRM32ER71H475KA88L
C207, C208, C209, C210	Capacitor, 100 μ F	Panasonic Electronic Components	EEE-FP1V101AP
C211	Capacitor, 3.9 pF	ATC	ATC100A3R9CW150XB
C212	Capacitor, 6.8 pF	ATC	ATC100A6R8JW150XB
C213, C215	Capacitor, 8.2 pF	ATC	ATC100A8R2JW150XB
C214	Capacitor, 5.6 pF	ATC	ATC100A5R6CW150XB
C216	Capacitor, 3.3 pF	ATC	ATC100A3R3CW150XB
C217, C218	Capacitor, 100 pF	ATC	ATC100A101JW150XB
C219	Capacitor, 91 pF	ATC	ATC100A910JW150XB
R201	Coax, 25 Ω	AMWAYE	UT-090C-25

Pinout Diagram (top view)

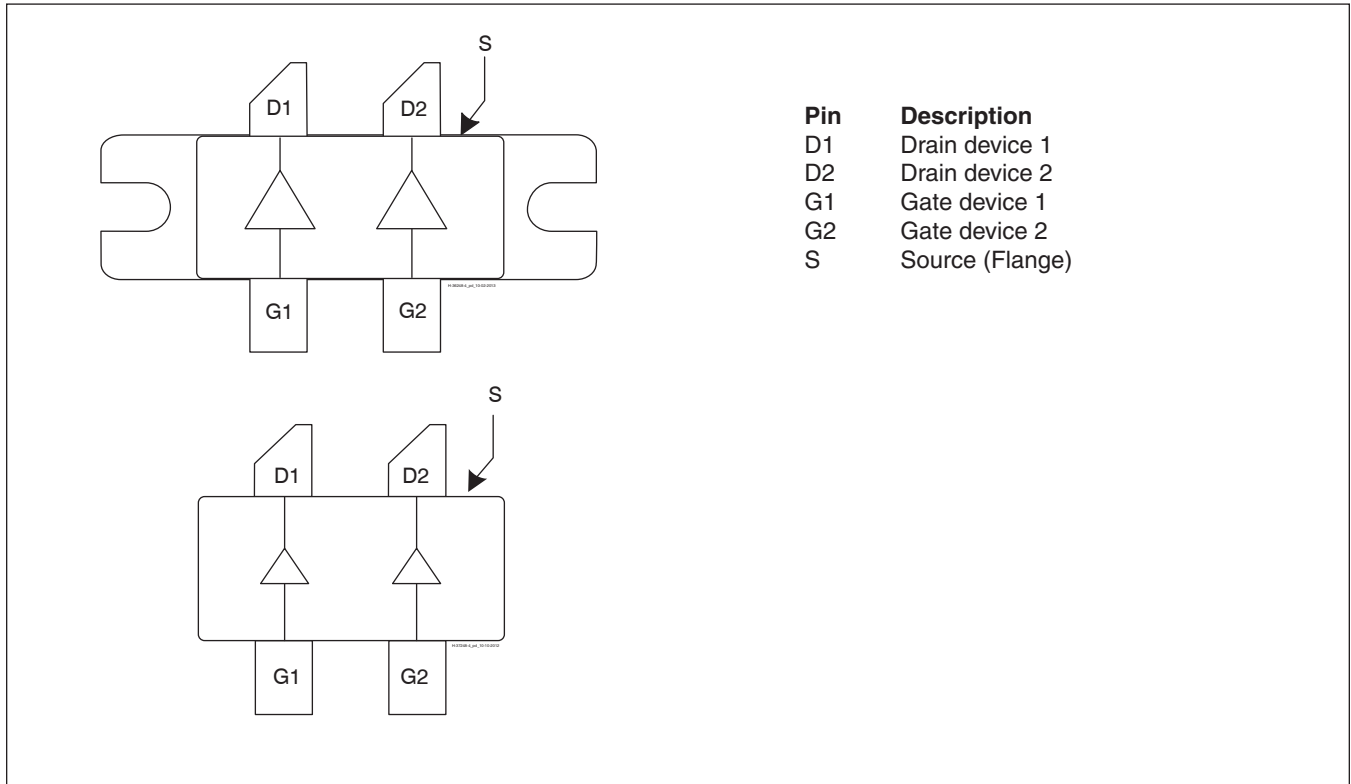

Lead connections for PTVA042502EC and PTVA042502FC

Package Outline Specifications

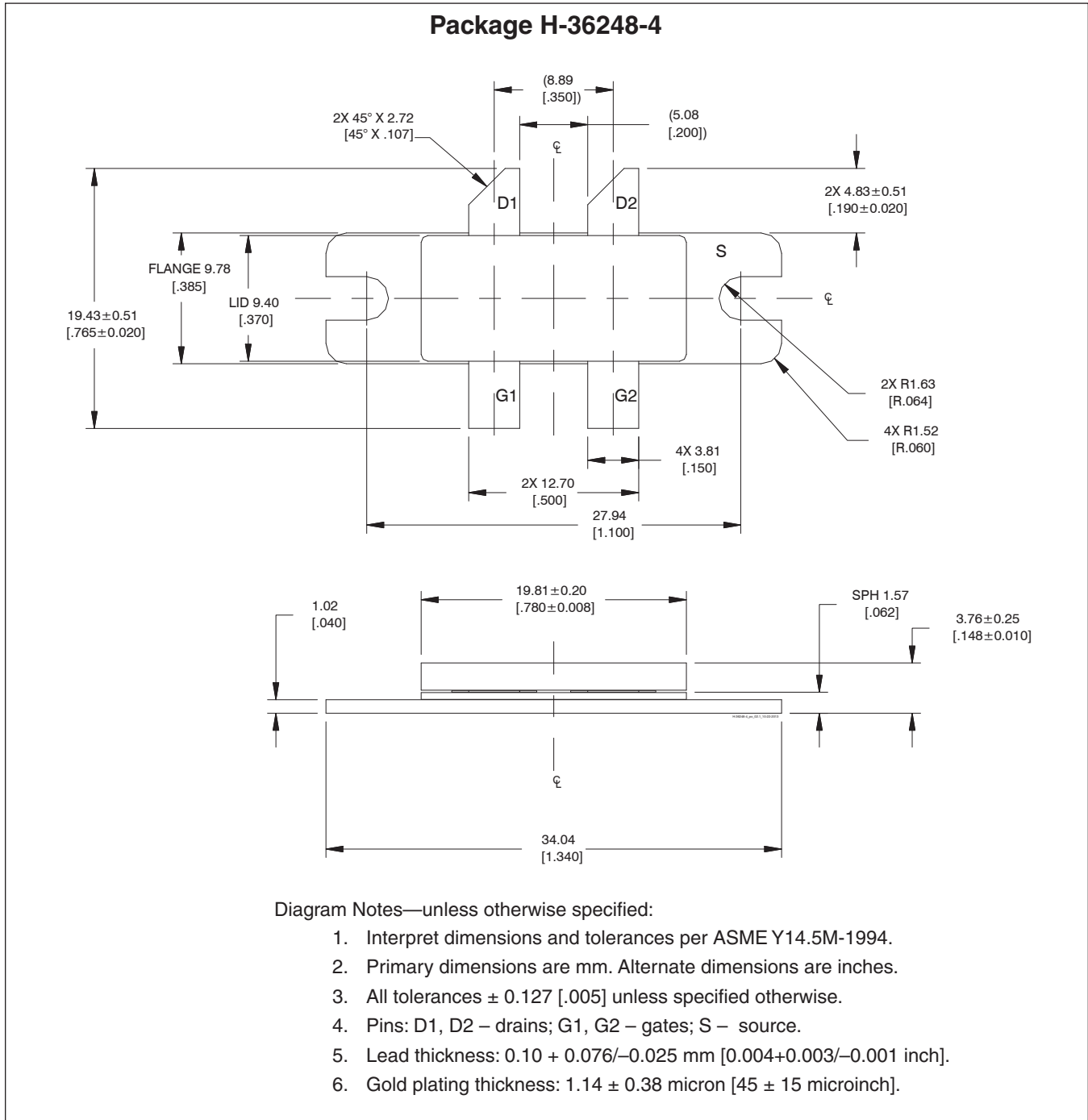

Package Outline Specifications (cont.)

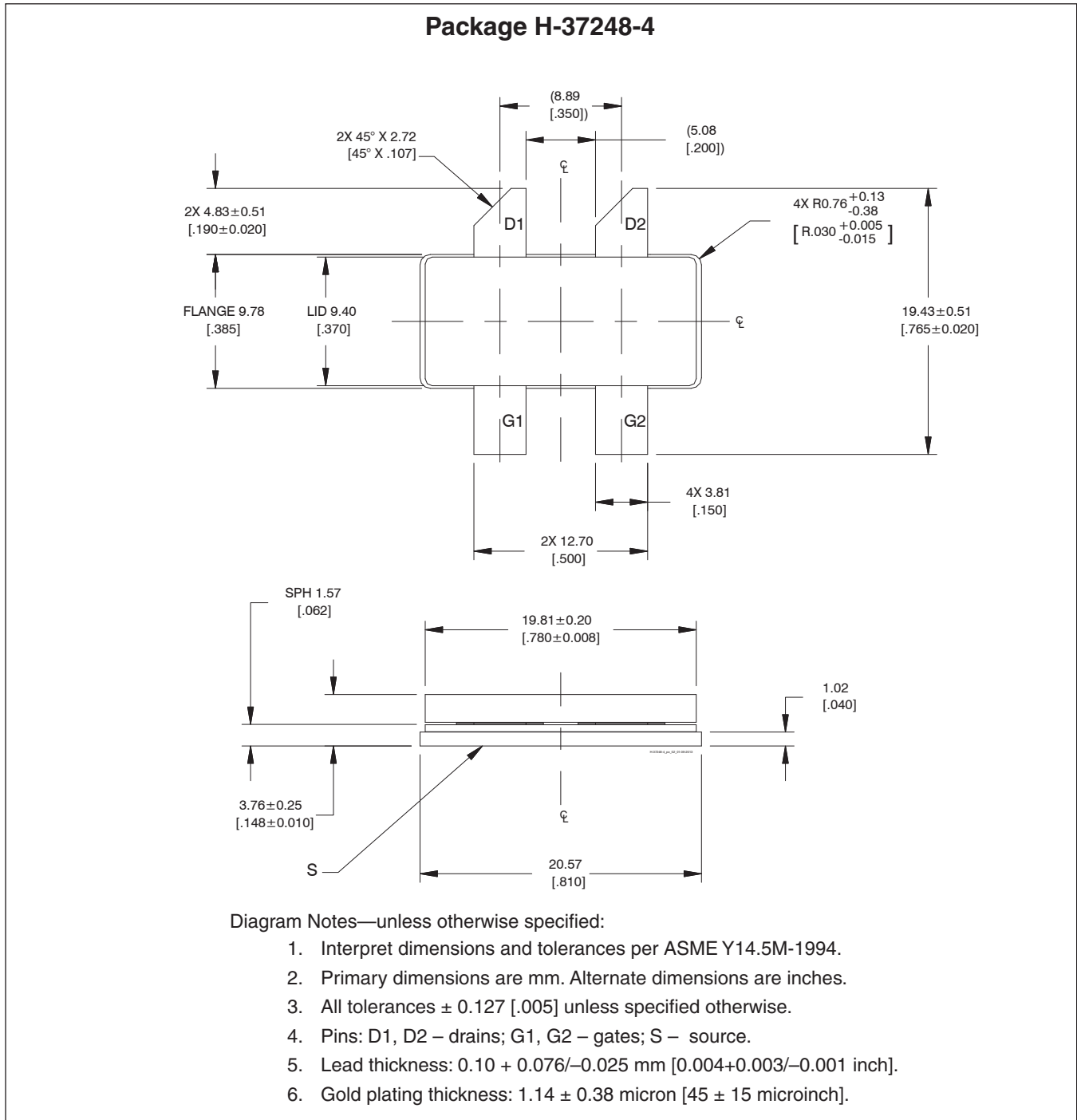

Find the latest and most complete information about products and packaging at the Infineon Internet page
<http://www.infineon.com/rfpower>

Revision History

Revision	Date	Data Sheet Type	Page	Subjects (major changes since last revision)
01	2012-09-19	Preliminary	All	Data Sheet reflects preliminary specification
02	2013-10-01	Preliminary	1 3 1, 2, 4, 5 6	Updated DVB-T characteristics, updated frequency range Updated DVB-T performance graphs Added H-36248-4 package information, pinout diagram and package outline Updated package outline specification
02.1	2013-10-20	Preliminary	1, 2	Removed obsolete Pulsed Characteristics from Features, Removed Obsolete Pulsed CW table
03	2014-05-26	Production	All 1, 2 3, 4	Data Sheet reflects released product specification Updated Features, DVB-T Characteristics table, thermal resistance Updated all graphs, added loadpull information
03.1	2016-04-19	Production	1, 2	Added ESD rating, updated ordering information

We Listen to Your Comments

Any information within this document that you feel is wrong, unclear or missing at all?
Your feedback will help us to continuously improve the quality of this document.
Please send your proposal (including a reference to this document) to:

highpowerRF@infineon.com

To request other information, contact us at:
+1 877 465 3667 (1-877-GO-LDMOS) USA
or +1 408 776 0600 International

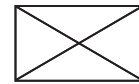

Edition 2016-04-19

Published by
Infineon Technologies AG
85579 Neubiberg, Germany

© 2012 Infineon Technologies AG
All Rights Reserved.

Legal Disclaimer

The information given in this document shall in no event be regarded as a guarantee of conditions or characteristics. With respect to any examples or hints given herein, any typical values stated herein and/or any information regarding the application of the device, Infineon Technologies hereby disclaims any and all warranties and liabilities of any kind, including without limitation, warranties of non-infringement of intellectual property rights of any third party.

Information

For further information on technology, delivery terms and conditions and prices, please contact the nearest Infineon Technologies Office (www.infineon.com/rfpower).

Warnings

Due to technical requirements, components may contain dangerous substances. For information on the types in question, please contact the nearest Infineon Technologies Office.

Infineon Technologies components may be used in life-support devices or systems only with the express written approval of Infineon Technologies, if a failure of such components can reasonably be expected to cause the failure of that life-support device or system or to affect the safety or effectiveness of that device or system. Life support devices or systems are intended to be implanted in the human body or to support and/or maintain and sustain and/or protect human life. If they fail, it is reasonable to assume that the health of the user or other persons may be endangered.