

## Thermally-Enhanced High Power RF LDMOS FET 240 W, 28 V, 1805 – 1880 MHz

### Description

The PXAC182908FV is a 240-watt LDMOS FET with an asymmetrical design intended for use in multi-standard cellular power amplifier applications in the 1805 to 1880 MHz frequency band. Features include dual-path design, input and output matching, high gain and thermally-enhanced package with earless flanges. Manufactured with Infineon's advanced LDMOS process, this device provides excellent thermal performance and superior reliability.

PXAC182908FV  
Package H-37275G-6/2

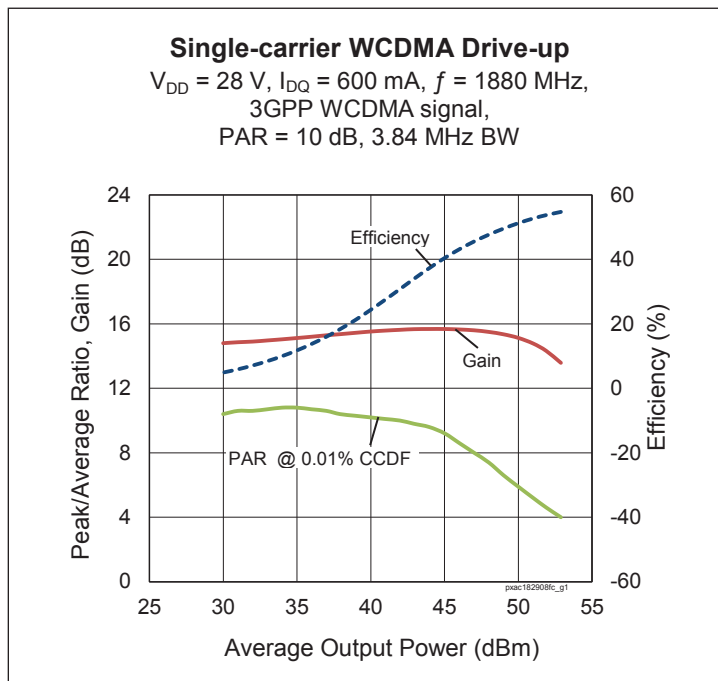

### Features

- Broadband internal input and output matching
- Asymmetrical Doherty design
  - Main :  $P_{1dB} = 120\text{ W Typ}$
  - Peak :  $P_{1dB} = 220\text{ W Typ}$
- Typical Pulsed CW performance, 1842.5 MHz, 28 V, combined outputs
  - Output power at  $P_{1dB} = 240\text{ W}$
  - Efficiency = 52.6%
  - Gain = 14.5 dB
- Capable of handling 10:1 VSWR @28 V, 240 W (CW) output power
- Human Body Model Class 2 (per ANSI/ESDA/ JEDEC JS-001)
- Integrated ESD protection
- Low thermal resistance
- Pb-free and RoHS compliant

### RF Characteristics

#### Single-carrier WCDMA Specifications (tested in Infineon Doherty test fixture)

$V_{DD} = 28\text{ V}$ ,  $I_{DQ} = 600\text{ mA}$ ,  $V_{GSPEAK} = 0.70\text{ V}$ ,  $P_{OUT} = 70\text{ W avg}$ ,  $f_1 = 1880\text{ MHz}$ , 3GPP signal, channel bandwidth = 3.84 MHz, peak/average = 10 dB @ 0.01% CCDF

Characteristic	Symbol	Min	Typ	Max	Unit
Gain	$G_{ps}$	14	15	—	dB
Drain Efficiency	$\eta_D$	49.5	51	—	%
Adjacent Channel Power Ratio	ACPR	—	-27.5	-25	dBc

All published data at  $T_{CASE} = 25^\circ\text{C}$  unless otherwise indicated

**ESD:** Electrostatic discharge sensitive device—observe handling precautions!

**DC Characteristics** (each side)

Characteristic	Conditions	Symbol	Min	Typ	Max	Unit
Drain-Source Breakdown Voltage	$V_{GS} = 0\text{ V}$ , $I_{DS} = 10\text{ mA}$	$V_{(BR)DSS}$	65	—	—	V
Drain Leakage Current	$V_{DS} = 28\text{ V}$ , $V_{GS} = 0\text{ V}$	$I_{DSS}$	—	—	1	$\mu\text{A}$
	$V_{DS} = 60\text{ V}$ , $V_{GS} = 0\text{ V}$	$I_{DSS}$	—	—	10	$\mu\text{A}$
On-State Resistance (main)	$V_{GS} = 10\text{ V}$ , $V_{DS} = 0.1\text{ V}$	$R_{DS(on)}$	—	0.11	—	$\Omega$
	(peak) $V_{GS} = 10\text{ V}$ , $V_{DS} = 0.1\text{ V}$	$R_{DS(on)}$	—	0.06	—	$\Omega$
Operating Gate Voltage (main)	$V_{DS} = 28\text{ V}$ , $I_{DQ} = 600\text{ mA}$	$V_{GS}$	2.45	2.70	2.95	V
	(peak) $V_{DS} = 28\text{ V}$ , $I_{DQ} = 0\text{ A}$	$V_{GS}$	0.45	0.60	0.80	V
Gate Leakage Current	$V_{GS} = 10\text{ V}$ , $V_{DS} = 0\text{ V}$	$I_{GSS}$	—	—	1	$\mu\text{A}$

**Maximum Ratings**

Parameter	Symbol	Value	Unit
Drain-Source Voltage	$V_{DSS}$	65	V
Gate-Source Voltage	$V_{GS}$	-6 to +10	V
Operating Voltage	$V_{DD}$	0 to +32	V
Junction Temperature	$T_J$	225	$^{\circ}\text{C}$
Storage Temperature Range	$T_{STG}$	-65 to +150	$^{\circ}\text{C}$
Thermal Resistance (main, $T_{CASE} = 70^{\circ}\text{C}$ , 56 W CW)	$R_{\theta JC}$	0.56	$^{\circ}\text{C/W}$
	(peak, $T_{CASE} = 70^{\circ}\text{C}$ , 200 W CW)	$R_{\theta JC}$	0.29

**Ordering Information**

Type and Version	Order Code	Package Description	Shipping
PXAC182908FV V1 R0	PXAC182908FVV1R0XTMA1	H-37275G-6/2, earless flange	Tape & Reel, 50 pcs
PXAC182908FV V1 R250	PXAC182908FVV1R250XTMA1	H-37275G-6/2, earless flange	Tape & Reel, 250 pcs

**Typical Performance** (data taken in a production test fixture)

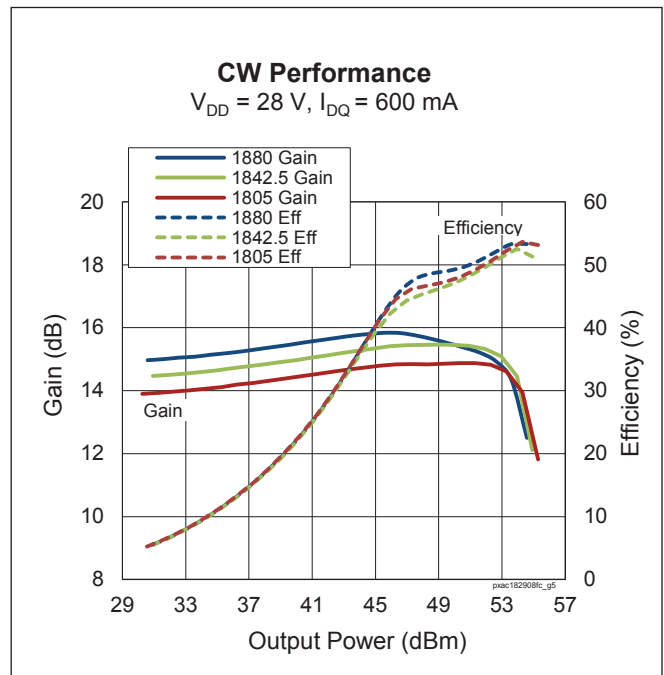
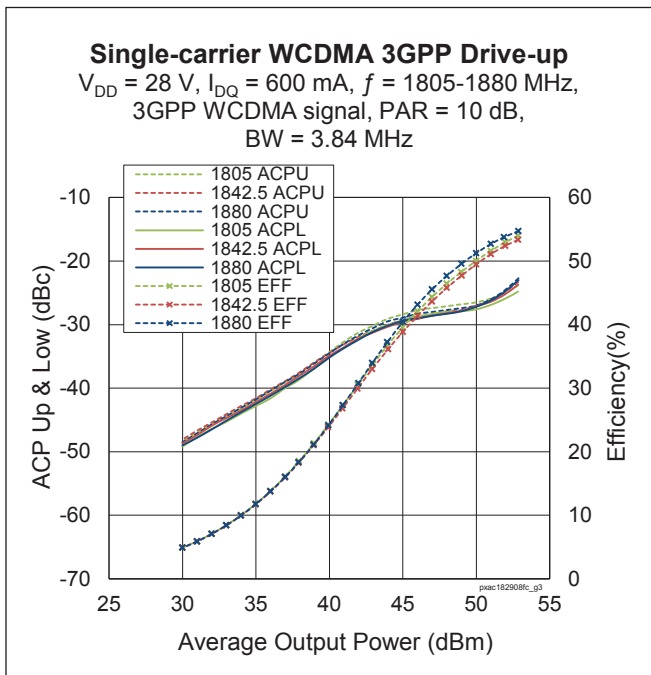
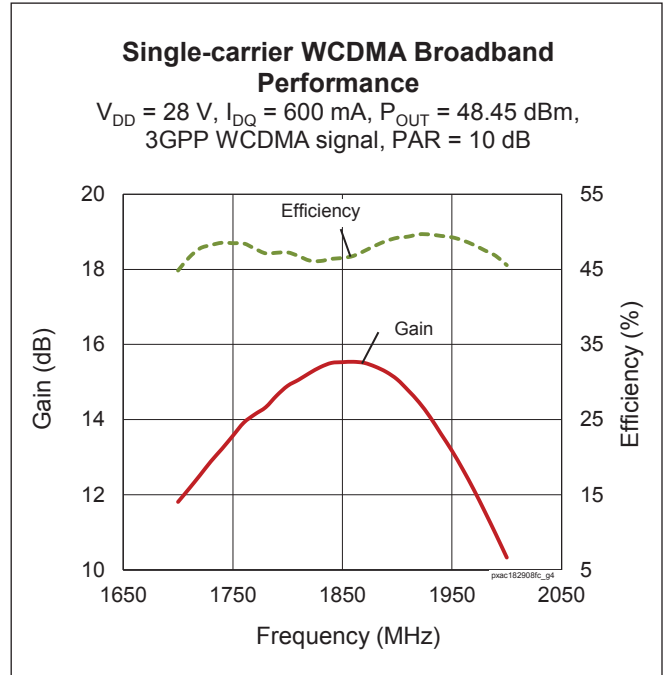
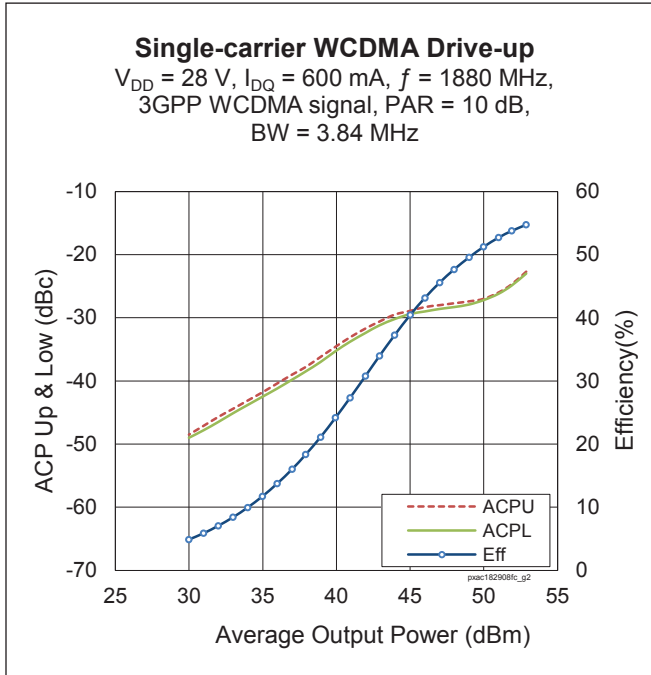

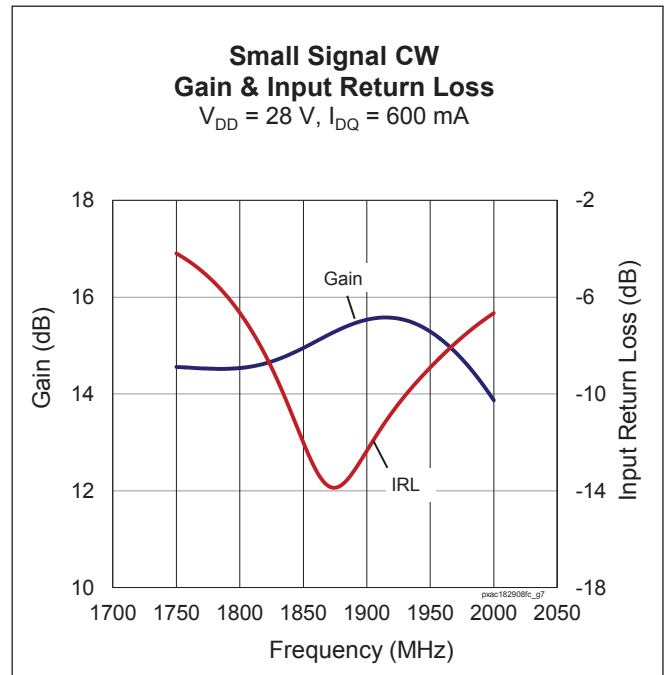
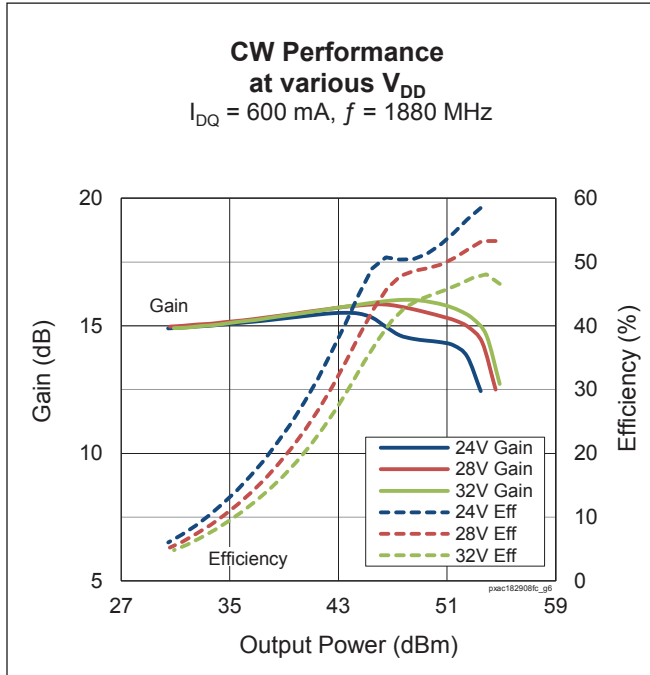
**Typical Performance (cont.)**

**Load Pull Performance**
**Main Side Load Pull Performance** – Pulsed CW signal: 10  $\mu\text{s}$ , 10% duty cycle, 28 V,  $I_{DQ} = 720 \text{ mA}$ 

Freq [MHz]	$Z_s$ [ $\Omega$ ]	$P_{1dB}$									
		Max Output Power					Max PAE				
		$Z_L$ [ $\Omega$ ]	Gain [dB]	$P_{OUT}$ [dBm]	$P_{OUT}$ [W]	$\eta_D$ [%]	$Z_L$ [ $\Omega$ ]	Gain [dB]	$P_{OUT}$ [dBm]	$P_{OUT}$ [W]	$\eta_D$ [%]
1805	4.98+j9.12	2.04-j3.48	19.6	51.3	133	55.3	3.50-j2.06	21.4	50.0	99	63.6
1842.5	2.98+j7.93	2.19-j3.56	19.0	51.3	136	55.9	3.48-j1.96	20.9	49.9	99	64.0
1880	1.98+j6.60	2.18-j3.52	20.0	51.2	132	55.7	3.36-j1.89	21.9	49.8	95	64.0

**Peak Side Load Pull Performance** – Pulsed CW signal: 10  $\mu\text{s}$ , 10% duty cycle, 28 V,  $I_{DQ} = 100 \text{ mA}$ 

Freq [MHz]	$Z_s$ [ $\Omega$ ]	$P_{1dB}$									
		Max Output Power					Max PAE				
		$Z_L$ [ $\Omega$ ]	Gain [dB]	$P_{OUT}$ [dBm]	$P_{OUT}$ [W]	$\eta_D$ [%]	$Z_L$ [ $\Omega$ ]	Gain [dB]	$P_{OUT}$ [dBm]	$P_{OUT}$ [W]	$\eta_D$ [%]
1805	0.68-j3.85	4.06-j3.83	18.6	54.2	261	55.4	3.01-j0.87	20.4	52.5	176	64.1
1842.5	0.60-j4.14	4.50-j3.68	18.9	54.1	258	55.3	3.02-j1.36	20.6	52.8	192	64.3
1880	0.87-j4.71	5.12-j3.69	18.8	54.0	249	54.0	3.01-j1.52	20.5	52.8	192	64.6

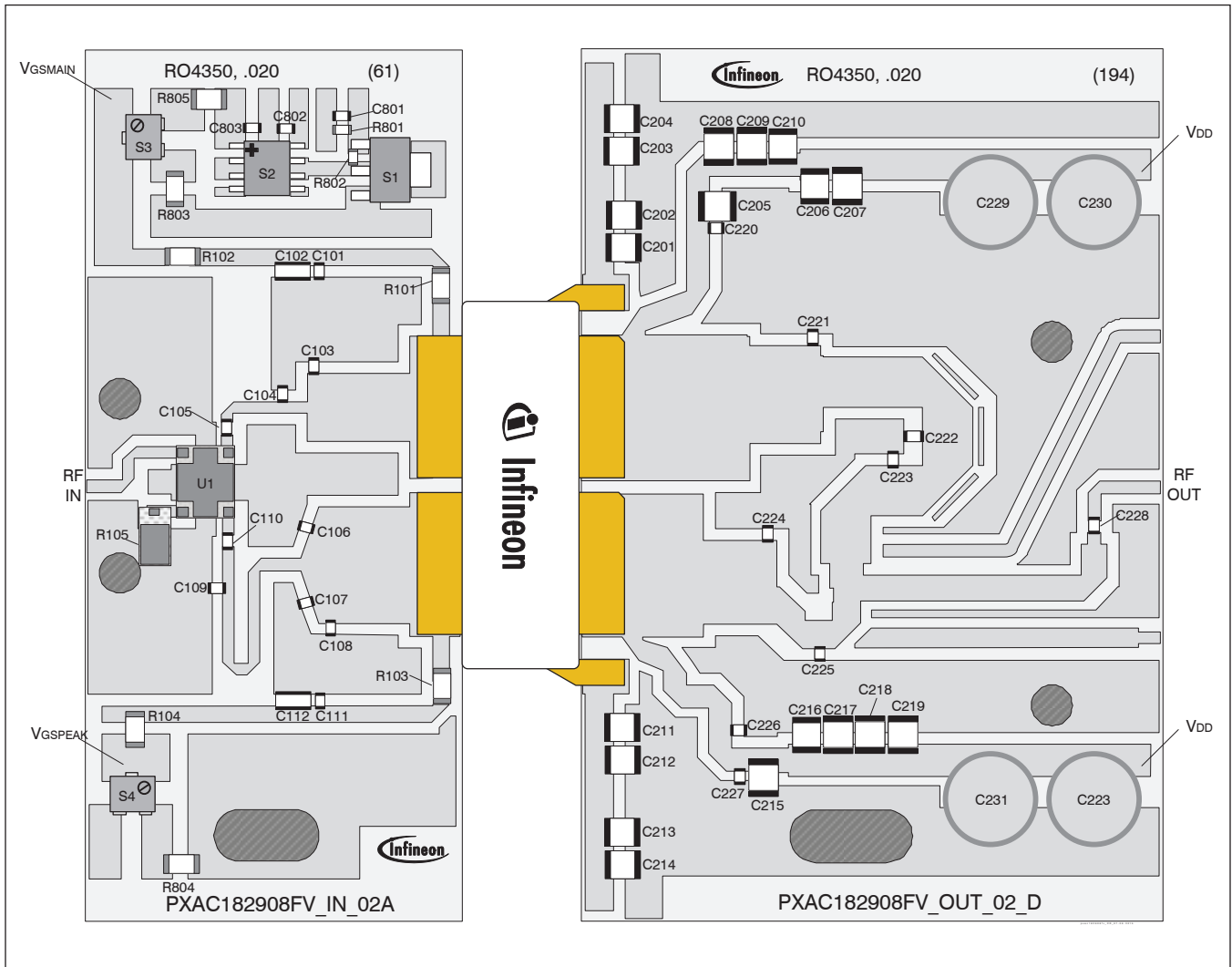
Reference Circuit , 1805 – 1880 MHz



Reference circuit assembly diagram (not to scale)

**Reference Circuit** (cont.)

**Reference Circuit Assembly**

DUT	PXAC182908FV V1
Test Fixture Part No.	LTA/PXAC182908FV V1
PCB	Rogers 4350, 0.508 mm [0.020"] thick, 2 oz. copper, $\epsilon_r = 3.66$ , $f = 1805 - 1880$ MHz
Find Gerber files for this test fixture on the Infineon Web site at <a href="http://www.infineon.com/rfpower">http://www.infineon.com/rfpower</a>	

**Components Information**

Component	Description	Manufacturer	P/N
<b>Input</b>			
C101, C105, C110, C111	Capacitor, 18 pF	ATC	ATC100A180JW150XB
C102, C112	Capacitor, 10 $\mu$ F	Murata	LLL31BC70G106MA01L
C103	Capacitor, 1.5 pF	ATC	ATC100A1R5CW150XB
C104	Capacitor, 3.0 pF	ATC	ATC100A3R0CW150XB
C106	Capacitor, 0.4 pF	ATC	ATC100A0R4CW150XB
C107	Capacitor, 1.0 pF	ATC	ATC100A1R0CW150XB
C108	Capacitor, 0.7 pF	ATC	ATC100A0R7CW150XB
C109	Capacitor, 0.5 pF	ATC	ATC100A0R5CW150XB
C801, C802, C803	Capacitor, 1000 pF	Panasonic Electronic Components	ECJ-1VB1H102K
R101, R103	Resistor, 5.1 $\Omega$	Panasonic Electronic Components	ERJ-8GEYJ5R1V
R102, R104	Resistor, 1K $\Omega$	Panasonic Electronic Components	ERJ-8GEYJ102V
R105	Resistor, 50 $\Omega$	Richardson	RICHARDSON
R801	Resistor, 1.3K $\Omega$	Panasonic Electronic Components	ERJ-3GEYJ132V
R802	Resistor 1.2K $\Omega$	Panasonic Electronic Components	ERJ-3GEYJ122V
R803, R804, R805	Resistor, 50 $\Omega$	Panasonic Electronic Components	ERJ-8GEYJ510V
S1	Transistor	Infineon Technologies	BCP56
S2	Voltage regulator	Texas Instruments	LM78L05ACM
S3, S4	Potentiometer, 2k $\Omega$	Bourns Inc.	3224W-1-202E
U1	Hybrid coupler	Anaren	X3C19P1-05S
<b>Output</b>			
C201, C202, C203, C204, C205, C206, C207, C208, C209, C210, C211, C212, C213, C214, C215, C216, C217, C218, C219	Capacitor, 10 $\mu$ F	Taiyo Yuden	UMK325C7106MM-T
C220, C226, C227, C228	Capacitor, 18 pF	ATC	ATC100A180JW150XB
C221	Capacitor, 2.2 pF	ATC	ATC100A2R2CW150XB
C222	Capacitor, 0.3 pF	ATC	ATC100A0R3CW150XB
C223	Capacitor, 1.2 pF	ATC	ATC100A1R2CW150XB
C224	Capacitor, 0.4 pF	ATC	ATC100A0R4CW150XB
C225	Capacitor, 1.1 pF	ATC	ATC100A1R1CW150XB
C229, C230, C231, C232	Capacitor, 220 $\mu$ F	Panasonic Electronic Components	EEE-FP1V221AP

**Pinout Diagram** (top view)

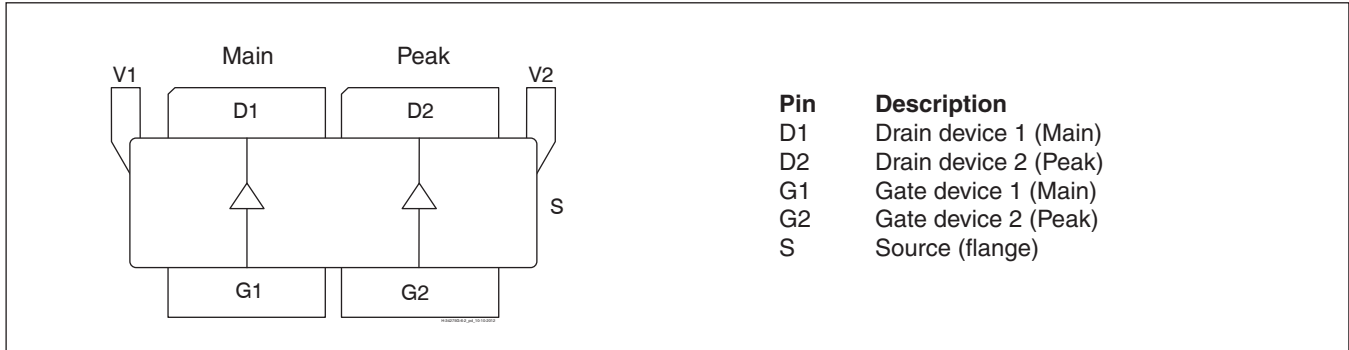

Lead connections for PXAC182908FV

Package Outline Specifications

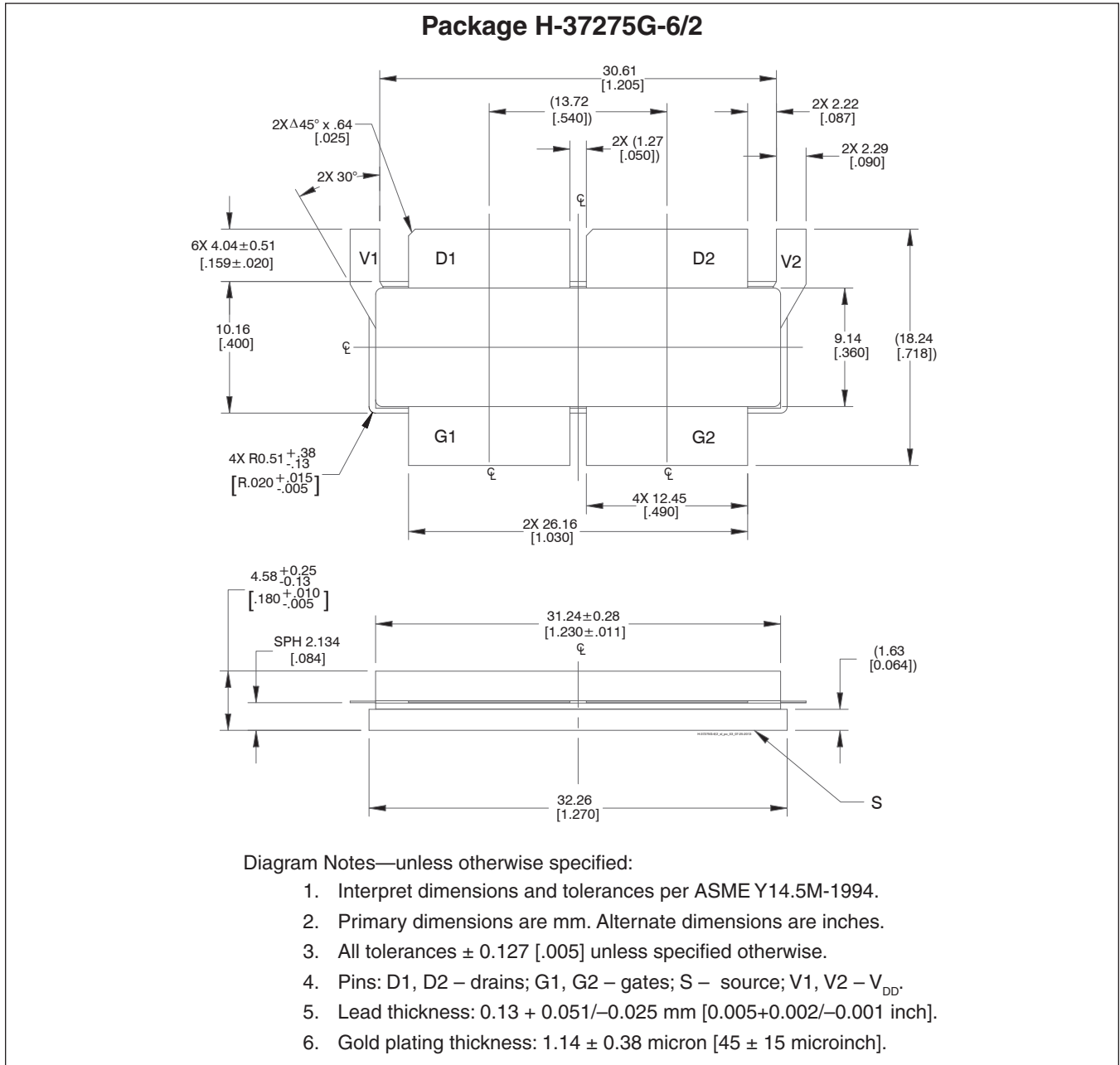

Find the latest and most complete information about products and packaging at the Infineon Internet page <http://www.infineon.com/rfpower>



## Revision History

Revision	Date	Data Sheet Type	Page	Subjects (major changes since last revision)
01	2015-01-08	Advance	All	Data Sheet reflects advance specification for product development
01.1	2015-01-29	Advance	2	Updated thermal resistance
02	2015-07-07	Production	All All	Data Sheet reflects released product specification Revised all data and includes updated final specs, typical performance graphs, loadpull, reference circuit, package outline
02.1	2015-07-29	Production	4	Corrected Drain Eff to PAE in Load Pull tablehead

### We Listen to Your Comments

Any information within this document that you feel is wrong, unclear or missing at all?  
Your feedback will help us to continuously improve the quality of this document.  
Please send your proposal (including a reference to this document) to:

[\(highpowerRF@infineon.com\)](mailto:highpowerRF@infineon.com)

To request other information, contact us at:  
+1 877 465 3667 (1-877-GO-LDMOS) USA  
or +1 408 776 0600 International



### Edition 2015-07-29

Published by  
**Infineon Technologies AG**  
85579 Neubiberg, Germany

© 2015 Infineon Technologies AG  
All Rights Reserved.

### Legal Disclaimer

The information given in this document shall in no event be regarded as a guarantee of conditions or characteristics. With respect to any examples or hints given herein, any typical values stated herein and/or any information regarding the application of the device, Infineon Technologies hereby disclaims any and all warranties and liabilities of any kind, including without limitation, warranties of non-infringement of intellectual property rights of any third party.

### Information

For further information on technology, delivery terms and conditions and prices, please contact the nearest Infineon Technologies Office ([www.infineon.com/rfpower](http://www.infineon.com/rfpower)).

### Warnings

Due to technical requirements, components may contain dangerous substances. For information on the types in question, please contact the nearest Infineon Technologies Office.

Infineon Technologies components may be used in life-support devices or systems only with the express written approval of Infineon Technologies, if a failure of such components can reasonably be expected to cause the failure of that life-support device or system or to affect the safety or effectiveness of that device or system. Life support devices or systems are intended to be implanted in the human body or to support and/or maintain and sustain and/or protect human life. If they fail, it is reasonable to assume that the health of the user or other persons may be endangered.