

Thermally-Enhanced High Power RF LDMOS FET 150 W, 28 V, 2300 – 2400 MHz

Description

The PXAC241702FC is a 28 V LDMOS FET with an asymmetrical design intended for use in multi-standard cellular power amplifier applications in the 2300 to 2400 MHz frequency band. Features include dual-path design, high gain and thermally-enhanced package with earless flange. Manufactured with Infineon's advanced LDMOS process, this device provides excellent thermal performance and superior reliability.



PXAC241702FC
Package H-37248-4

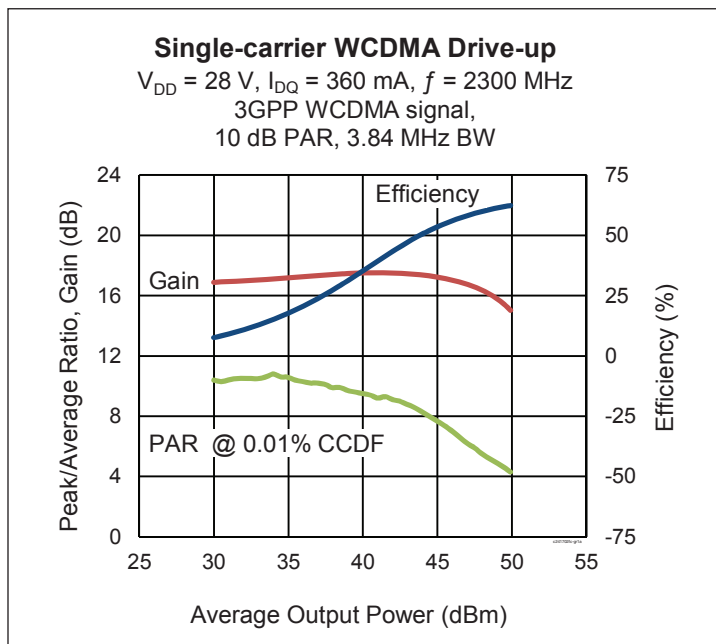

Features

- Asymmetrical Doherty design
 - Main: $P_{1dB} = 60\text{ W Typ}$
 - Peak: $P_{1dB} = 90\text{ W Typ}$
- Broadband internal input and output matching
- Typical pulsed CW performance, 2350 MHz, 28 V, Doherty configuration
 - Output power at $P_{1dB} = 100\text{ W}$
 - Efficiency = 49%
 - Gain = 17.5 dB
- Integrated ESD protection: Human Body Model, Class 1C (per JESD22-A114)
- Capable of handling 10:1 VSWR @ 28 V, 120 W (CW) output power
- Low thermal resistance
- Pb-free and RoHS compliant

RF Characteristics

Single-carrier WCDMA Specifications (tested in Infineon Doherty test fixture)

$V_{DD} = 28\text{ V}$, $I_{DQ(\text{main})} = 360\text{ mA}$, $V_{GS(\text{peak})} = 1.2\text{ V}$, $P_{OUT} = 28\text{ W avg}$, $f = 2400\text{ MHz}$. 3GPP signal, 3.84 MHz channel bandwidth, 10 dB peak/average @ 0.01% probability on CCDF.

Characteristic	Symbol	Min	Typ	Max	Unit
Gain	G_{ps}	15.5	16.5	—	dB
Drain Efficiency	η_D	46	52	—	%
Adjacent Channel Power Ratio	ACPR	—	-33.5	-28.0	dBc
Output PAR (at 0.01% probability on CCDF)	OPAR	6.5	7.5	—	dB

All published data at $T_{CASE} = 25^\circ\text{C}$ unless otherwise indicated

ESD: Electrostatic discharge sensitive device—observe handling precautions!

DC Characteristics (each side)

Characteristic	Conditions	Symbol	Min	Typ	Max	Unit
Drain-Source Breakdown Voltage	$V_{GS} = 0\text{ V}, I_{DS} = 10\text{ mA}$	$V_{(BR)DSS}$	65	—	—	V
Drain Leakage Current	$V_{DS} = 28\text{ V}, V_{GS} = 0\text{ V}$	I_{DSS}	—	—	1	μA
	$V_{DS} = 63\text{ V}, V_{GS} = 0\text{ V}$	I_{DSS}	—	—	10	μA
Gate Leakage Current	$V_{GS} = 10\text{ V}, V_{DS} = 0\text{ V}$	I_{GSS}	—	—	1	μA
On-State Resistance	(main) $V_{GS} = 10\text{ V}, V_{DS} = 0.1\text{ V}$	$R_{DS(on)}$	—	0.19	—	Ω
	(peak) $V_{GS} = 10\text{ V}, V_{DS} = 0.1\text{ V}$	$R_{DS(on)}$	—	0.16	—	Ω
Operating Gate Voltage	(main) $V_{DS} = 28\text{ V}, I_{DQ} = 360\text{ mA}$	V_{GS}	2.3	2.65	3.0	V
	(peak) $V_{DS} = 28\text{ V}, I_{DQ} = 0\text{ mA}$	V_{GS}	0.8	1.30	1.8	V

Maximum Ratings

Parameter	Symbol	Value	Unit
Drain-Source Voltage	V_{DSS}	65	V
Gate-Source Voltage	V_{GS}	-6 to +10	V
Operating Voltage	V_{DD}	0 to +32	V
Junction Temperature	T_J	225	$^{\circ}\text{C}$
Storage Temperature Range	T_{STG}	-65 to +150	$^{\circ}\text{C}$
Thermal Resistance ($T_{CASE} = 70^{\circ}\text{C}, 100\text{ W CW}$)	$R_{\theta JC}$	0.53	$^{\circ}\text{C/W}$

Ordering Information

Type and Version	Order Code	Package and Description	Shipping
PXAC241702FC V1 R0	PXAC241702FCV1R0XTMA1	H-37248-4, ceramic open-cavity, push-pull, earless	Tape & Reel, 50 pcs
PXAC241702FC V1 R250	PXAC241702FCV1R250XTMA1	H-37248-4, ceramic open-cavity, push-pull, earless	Tape & Reel, 250 pcs

Typical Performance (data taken in an Infineon production test fixture)

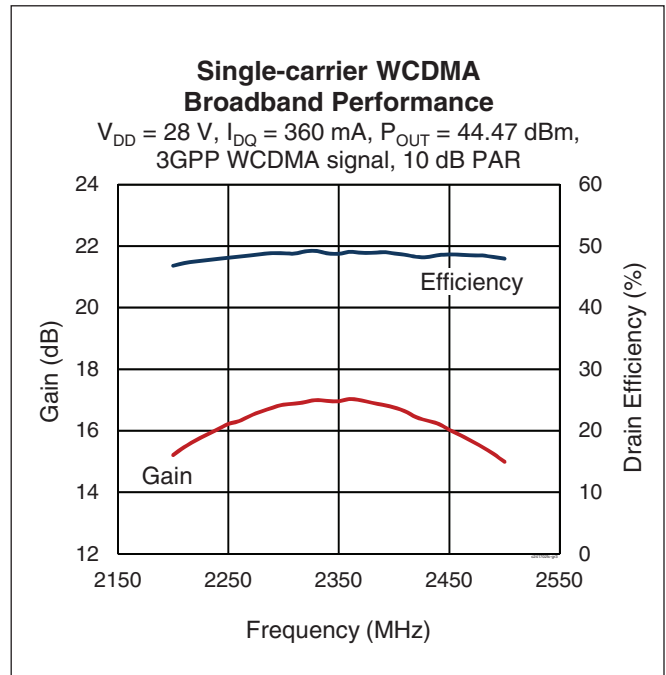
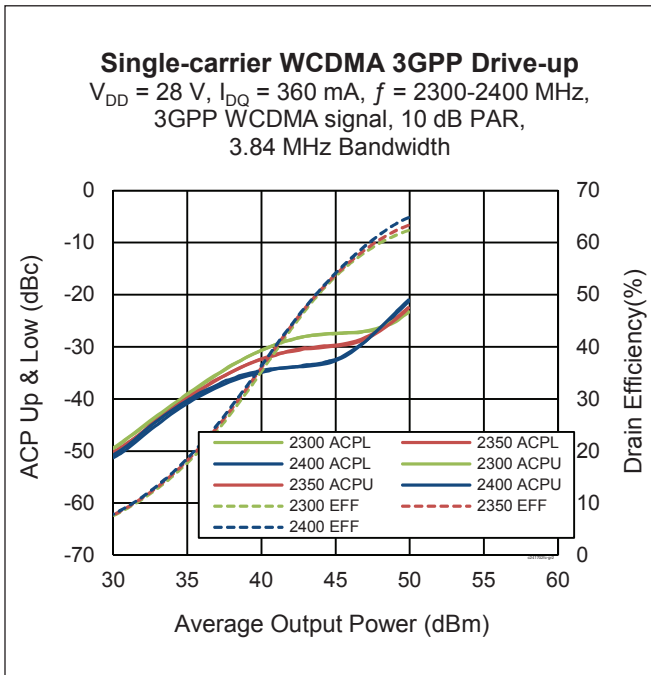
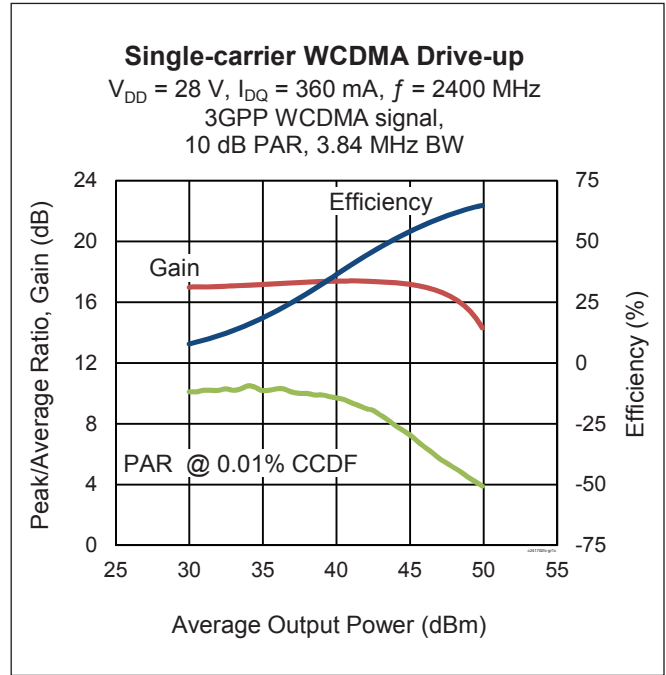
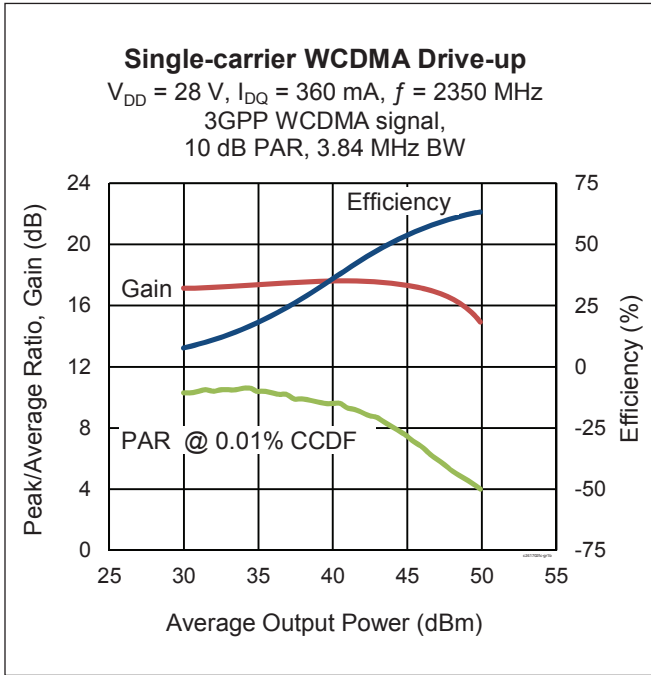

Typical Performance (cont.)

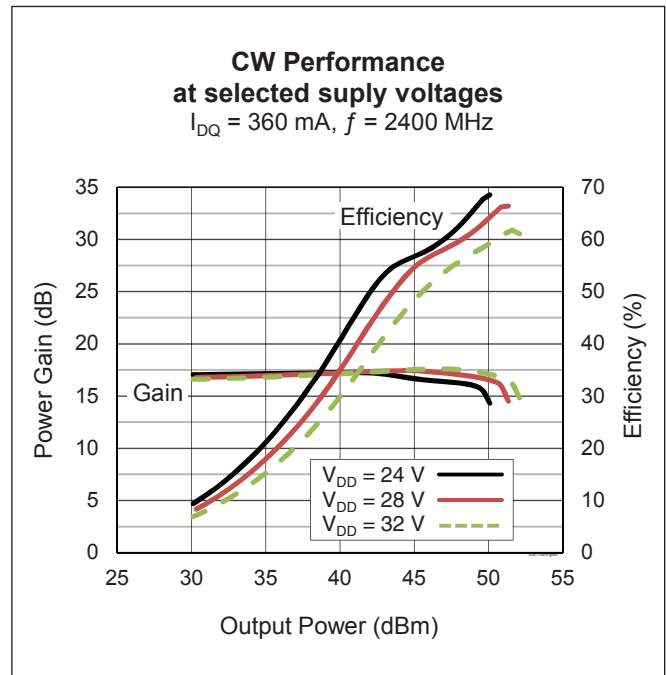
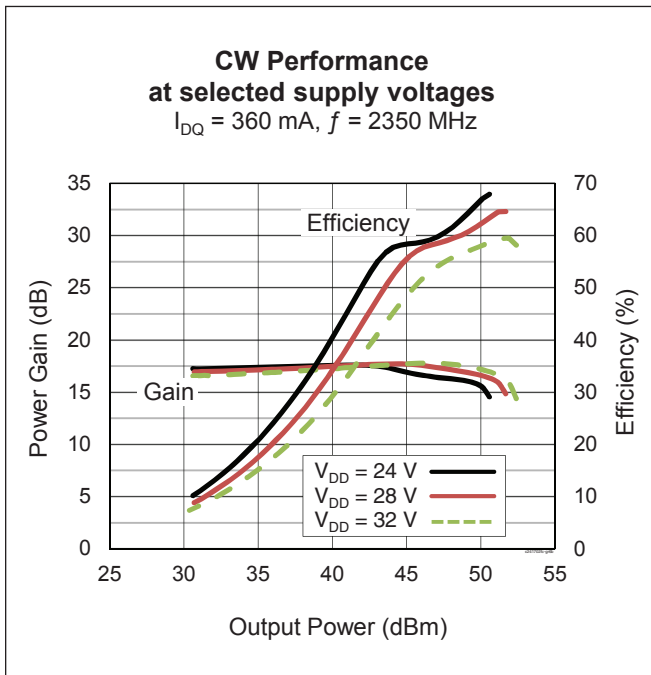
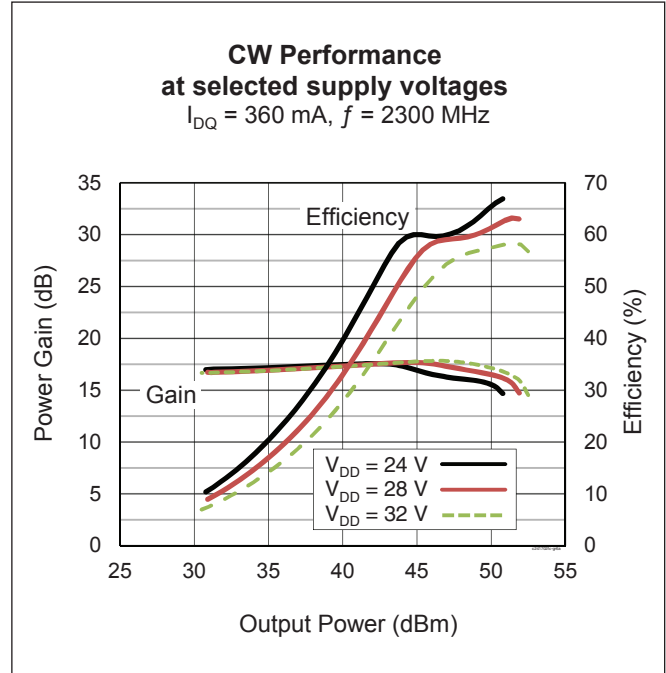
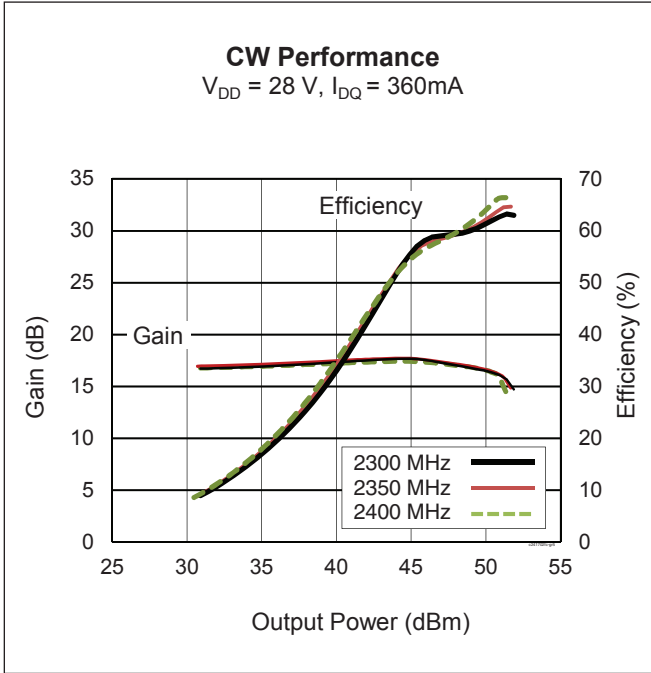

Typical Performance (cont.)

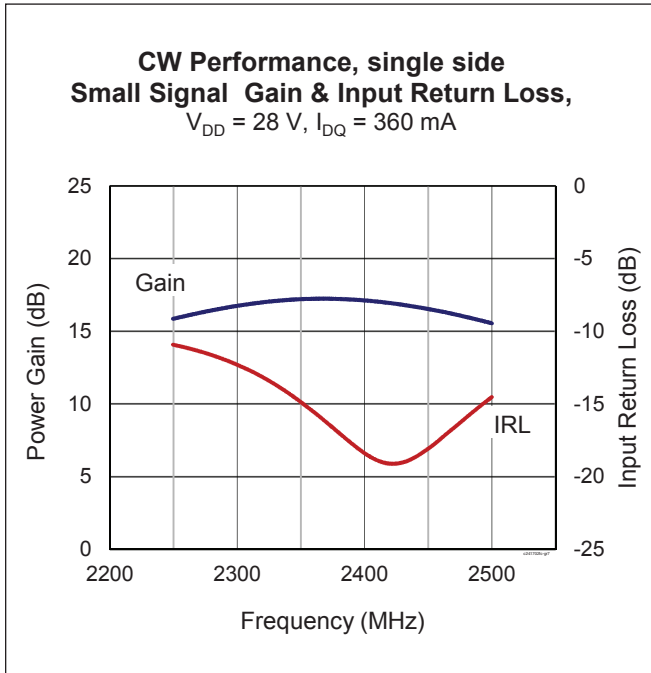

See next page for load pull performance

Load Pull Performance

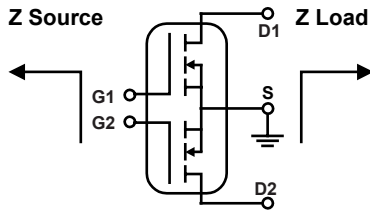

Main side pulsed CW signal: 160 μ sec, 10% duty cycle; 28 V, 360 mA

Class AB		P _{1dB}					P _{1dB}				
		Max Output Power					Max Efficiency				
Freq [MHz]	Z _{in} [Ω]	Gain [dB]	PAE [%]	P _{OUT} [dBm]	P _{OUT} [W]	Z _o [Ω]	Gain [dB]	PAE [%]	P _{OUT} [dBm]	P _{OUT} [W]	Z _o [Ω]
2300	7.02 – j16.25	18.46	48.25	48.26	66.99	3.70 – j5.99	21.09	60.29	46.10	40.78	7.31 – j2.51
2350	8.74 – j17.99	18.55	51.07	48.10	64.57	3.95 – j6.20	21.35	58.44	45.56	35.96	6.07 – j1.30
2400	12.84 – j19.05	18.51	49.06	47.87	61.24	4.07 – j6.49	21.28	58.55	45.90	38.91	5.53 – j1.93

Peak side pulsed CW signal: 160 μ sec, 10% duty cycle; 28 V, 540 mA

Class AB		P _{1dB}					P _{1dB}				
		Max Output Power					Max Efficiency				
Freq [MHz]	Z _{in} [Ω]	Gain [dB]	PAE [%]	P _{OUT} [dBm]	P _{OUT} [W]	Z _o [Ω]	Gain [dB]	PAE [%]	P _{OUT} [dBm]	P _{OUT} [W]	Z _o [Ω]
2300	6.20 – j13.36	17.67	52.03	50.03	100.69	2.61 – j6.18	19.73	59.11	48.52	71.07	4.52 – j4.62
2350	8.28 – j12.82	17.83	50.54	49.84	96.38	2.65 – j6.19	19.83	56.93	48.23	66.48	4.23 – j4.25
2400	10.47 – j14.25	17.66	49.75	49.77	94.84	2.52 – j6.34	20.75	56.70	47.17	52.14	4.10 – j2.69

Peak side pulsed CW signal: 160 μ sec, 10% duty cycle; 28 V, V_G = 1.5 V

Class C		P _{1dB}					P _{1dB}				
		Max Output Power					Max Efficiency				
Freq [MHz]	Z _{in} [Ω]	Gain [dB]	PAE [%]	P _{OUT} [dBm]	P _{OUT} [W]	Z _o [Ω]	Gain [dB]	PAE [%]	P _{OUT} [dBm]	P _{OUT} [W]	Z _o [Ω]
2300	6.20 – j13.36	14.18	58.22	50.38	109.14	2.47 – j5.92	15.13	64.64	48.83	76.42	4.33 – j4.75
2350	8.28 – j12.82	13.92	55.03	50.16	103.75	2.45 – j6.22	14.84	61.91	49.20	83.25	3.70 – j5.15
2400	10.47 – j14.25	14.08	53.80	50.08	101.86	2.31 – j6.36	15.19	60.42	47.54	56.77	4.17 – j3.00

Reference Circuit, 2300 MHz to 2400 MHz

DUT PXAC241702FC V1

Reference Circuit Part No. LTA/PXAC241702FC V1

PCB Rogers 4350, 0.508 mm [.020"] thick, 2 oz. copper, $\epsilon_r = 3.66$

Find Gerber files for this reference circuit on the Infineon Web site at www.infineon.com/rfpower

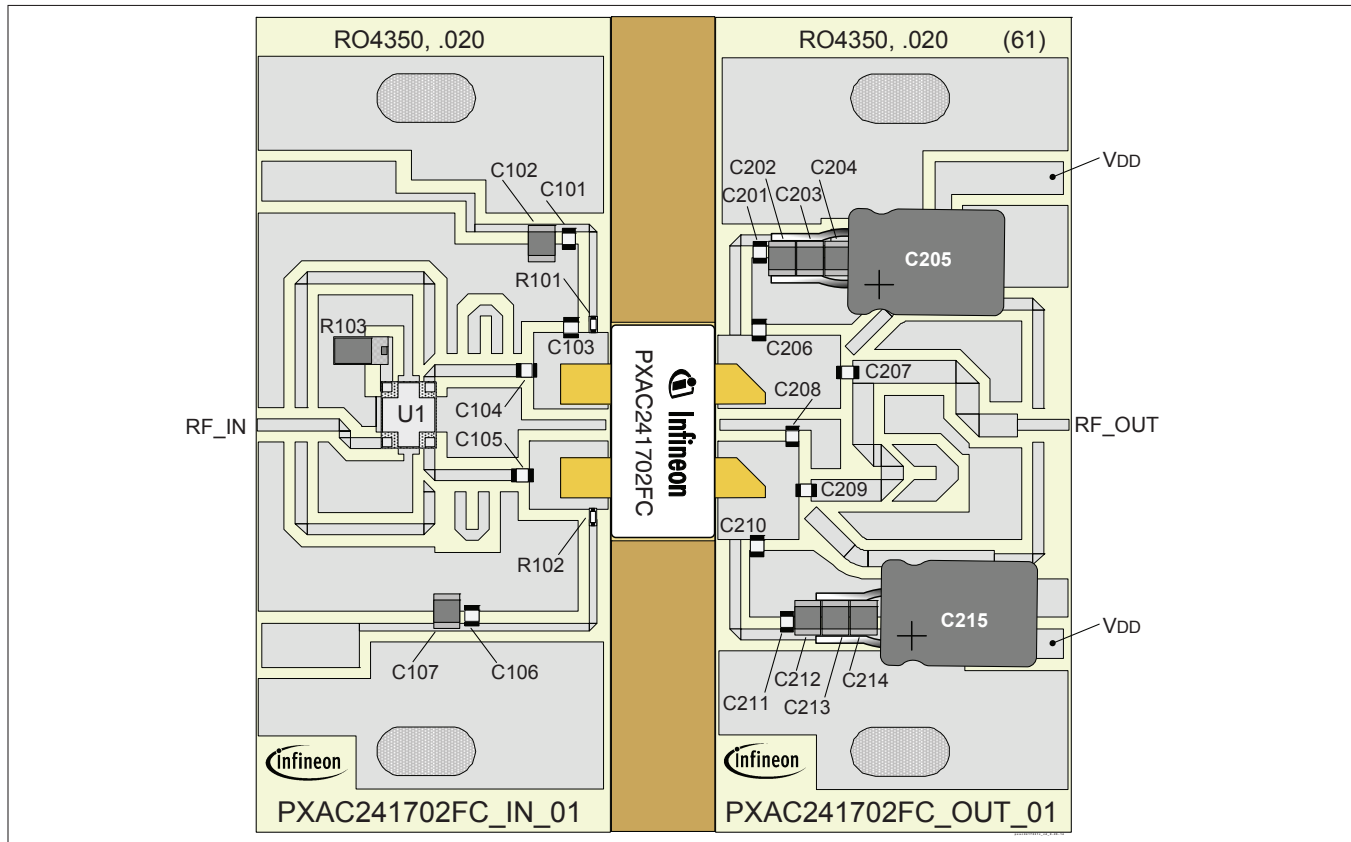
Reference Circuit (cont.)

Reference circuit assembly diagram (not to scale)
Component Information

Component	Description	Manufacturer	P/N
Input			
C101, C104, C105, C106	Capiacitor, 15 pF	ATC	600F150JT250
C102, C107	Capiacitor, 10 μ F	Taiyo Yuden	UMK325C7106MM-T
C103	Capiacitor, 0.3 pF	ATC	600F0R3BT250
R101, R102	Chip resistor, 10 ohms	Panasonic Electronic Components	ERJ-8GEYJ101V
R103	Chip resistor, 50 ohms	Anaren	C16A50Z4
U1	Coupler	Anaren	X3C25P1-02S
Output			
C201, C209, C211	Capiacitor, 15 pF	ATC	600F150JT250
C202, C203, C204, C212, C213, C214	Capiacitor, 10 μ F	Taiyo Yuden	UMK325C7106MM-T
C205, C215	Capiacitor, 220 μ F, 50 V	Cornell Dubilier Electronics (CDE)	SK221M050ST
C206	Capiacitor, 0.6 pF	ATC	600F0R6BT250
C207	Capiacitor, 4.7 pF	ATC	600F4R7BT250
C208, C210	Capiacitor, 1.2 pF	ATC	600F 1R2BT250

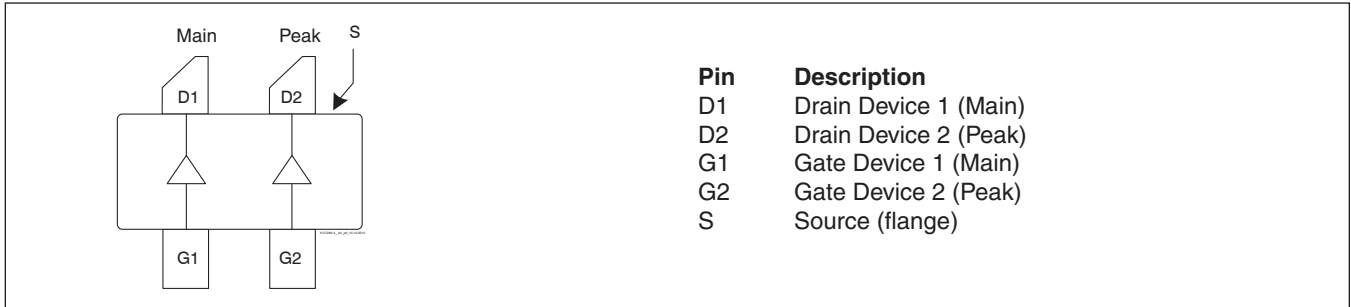
Pinout Diagram (top view)



Lead connections for PXAC241702FC

See next page for package mechanical specifications

Package Outline Specifications

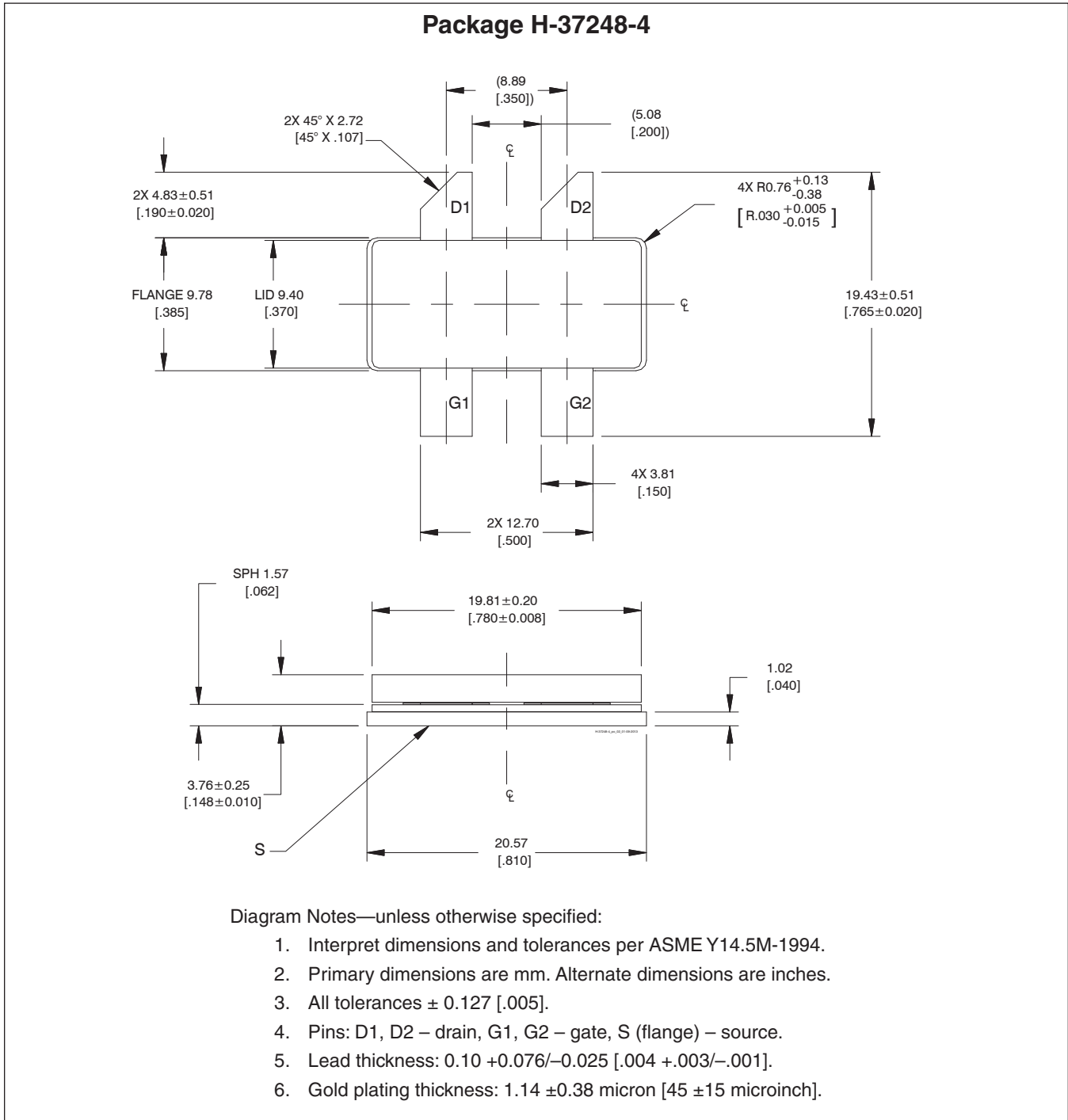

Find the latest and most complete information about products and packaging at the Infineon Internet page www.infineon.com/rfpower

Revision History

Revision	Date	Data Sheet	Page	Subjects (major changes since last revision)
01	2014-04-04	Advance	All	Data Sheet reflects advance specification for product development
02	2014-08-28	Production	All	Data Sheet represents released product specifications, including reference circuit and updated performance information.
02.1	2016-06-22	Production	2	Updated ordering information

We Listen to Your Comments

Any information within this document that you feel is wrong, unclear or missing at all?
Your feedback will help us to continuously improve the quality of this document.
Please send your proposal (including a reference to this document) to:

highpowerRF@infineon.com

To request other information, contact us at:
+1 877 465 3667 (1-877-GO-LDMOS) USA
or +1 408 776 0600 International

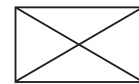

Edition 2016-06-22

**Published by
Infineon Technologies AG
85579 Neubiberg, Germany**

**© 2014 Infineon Technologies AG
All Rights Reserved.**

Legal Disclaimer

The information given in this document shall in no event be regarded as a guarantee of conditions or characteristics. With respect to any examples or hints given herein, any typical values stated herein and/or any information regarding the application of the device, Infineon Technologies hereby disclaims any and all warranties and liabilities of any kind, including without limitation, warranties of non-infringement of intellectual property rights of any third party.

Information

For further information on technology, delivery terms and conditions and prices, please contact the nearest Infineon Technologies Office (www.infineon.com/rfpower).

Warnings

Due to technical requirements, components may contain dangerous substances. For information on the types in question, please contact the nearest Infineon Technologies Office.

Infineon Technologies components may be used in life-support devices or systems only with the express written approval of Infineon Technologies, if a failure of such components can reasonably be expected to cause the failure of that life-support device or system or to affect the safety or effectiveness of that device or system. Life support devices or systems are intended to be implanted in the human body or to support and/or maintain and sustain and/or protect human life. If they fail, it is reasonable to assume that the health of the user or other persons may be endangered.