

High Power RF LDMOS Field Effect Transistor 350 W, 28 V, 2300 – 2400 MHz

Description

The PXAC243502FV LDMOS FET is a 350-watt LDMOS FET designed for use in power amplifier applications in the 2300 MHz to 2400 MHz frequency band. Features include an asymmetric design with high gain and a thermally-enhanced package with earless flange. Manufactured with Infineon's advanced LDMOS process, this device provides excellent thermal performance and superior reliability.



PXAC243502FV
Package H-37275-4

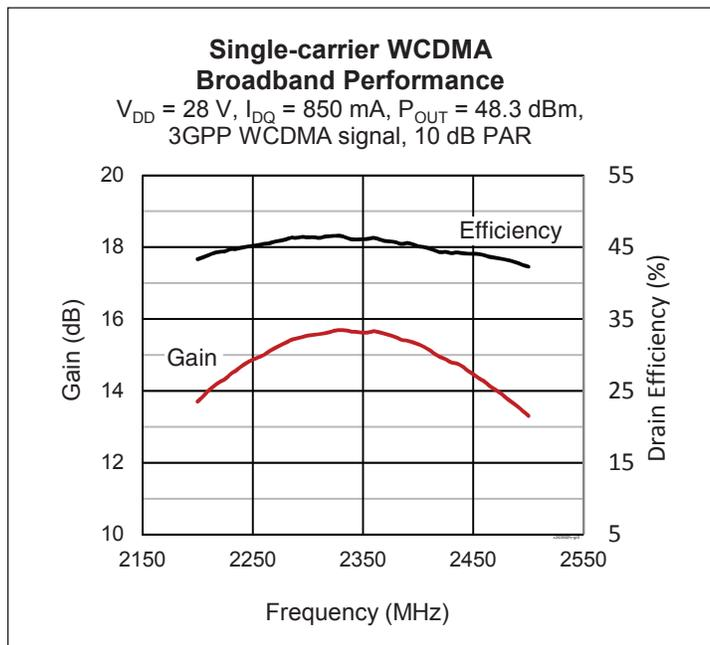

Features

- Asymmetric design
 - Main: 150 W P_{1dB}
 - Peak: 200 W P_{1dB}
- Broadband internal matching
- CW performance at 2350 MHz, 28 V
 - Output power = 250 W P_{1dB}
 - Efficiency = 46%
 - Gain = 16 dB
- Integrated ESD protection
- Human Body Model Class 2 (per ANSI/ESDA/ JEDEC JS-001)
- Low thermal resistance
- Pb-free and RoHS-compliant

RF Characteristics

Single-carrier WCDMA Specifications (tested in Infineon production test fixture in Doherty configuration)

$V_{DD} = 28\text{ V}$, $V_{GS(peak)} = 1.0\text{ V}$, $I_{DQ} = 850\text{ mA}$, $P_{OUT} = 68\text{ W avg}$, $f = 2400\text{ MHz}$
3GPP WCDMA signal, 3.84 MHz channel bandwidth, 10 dB peak/average @ 0.01% CCDF

Characteristic	Symbol	Min	Typ	Max	Unit
Gain	G_{ps}	14.0	15.0	—	dB
Drain Efficiency	η_D	42	45	—	%
Adjacent Channel Power Ratio	ACPR	—	-32	-26	dBc

All published data at $T_{CASE} = 25^\circ\text{C}$ unless otherwise indicated

ESD: Electrostatic discharge sensitive device—observe handling precautions!

DC Characteristics

Characteristic		Conditions	Symbol	Min	Typ	Max	Unit
Drain-Source Breakdown Voltage		$V_{GS} = 0\text{ V}, I_{DS} = 10\text{ mA}$	$V_{(BR)DSS}$	65	—	—	V
Drain Leakage Current		$V_{DS} = 28\text{ V}, V_{GS} = 0\text{ V}$	I_{DSS}	—	—	1	μA
		$V_{DS} = 63\text{ V}, V_{GS} = 0\text{ V}$	I_{DSS}	—	—	10	μA
Gate Leakage Current		$V_{GS} = 10\text{ V}, V_{DS} = 0\text{ V}$	I_{GSS}	—	—	1	μA
On-State Resistance	main	$V_{GS} = 10\text{ V}, V_{DS} = 0.1\text{ V}$	$R_{DS(on)}$	—	0.088	—	Ω
	peak	$V_{GS} = 10\text{ V}, V_{DS} = 0.1\text{ V}$	$R_{DS(on)}$	—	0.088	—	Ω
Operating Gate Voltage	main	$V_{DS} = 28\text{ V}, I_{DQ} = 850\text{ mA}$	V_{GS}	2.3	2.6	3.0	V
	peak	$V_{DS} = 28\text{ V}, I_{DQ} = 0\text{ mA}$	V_{GS}	0.8	1.2	1.6	V

Maximum Ratings

Parameter	Symbol	Value	Unit
Drain-Source Voltage	V_{DSS}	65	V
Gate-Source Voltage	V_{GS}	-6 to +10	V
Operating Voltage	V_{DD}	0 to +32	V
Junction Temperature	T_J	225	$^{\circ}\text{C}$
Storage Temperature Range	T_{STG}	-65 to +150	$^{\circ}\text{C}$
Thermal Resistance ($T_{CASE} = 70^{\circ}\text{C}, 250\text{ W CW}$)	$R_{\theta JC}$	0.22	$^{\circ}\text{C/W}$

Ordering Information

Type and Version	Order Code	Package and Description	Shipping
PXAC243502FV V1 R0	PXAC243502FVV1R0XTMA1	H-37275-4	Tape & Reel, 50 pcs
PXAC243502FV V1 R250	PXAC243502FVV1R250XTMA1	H-37275-4	Tape & Reel, 250 pcs

Typical RF Performance (data taken in production test fixture)

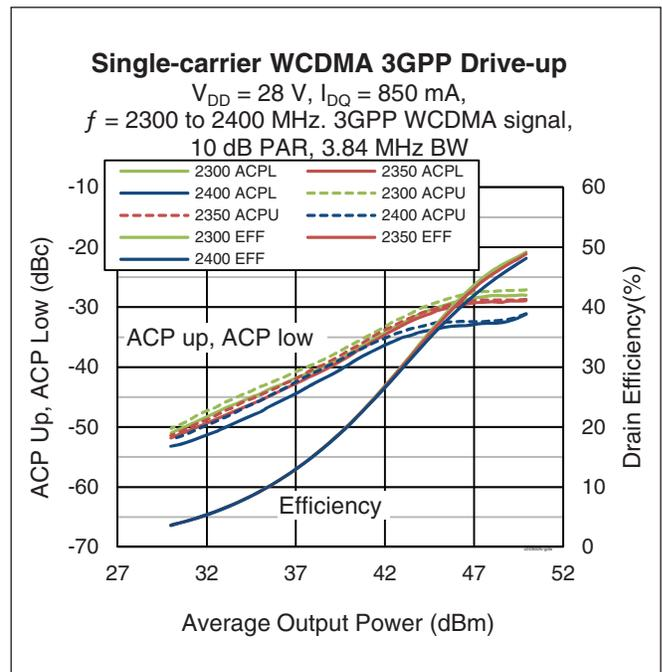
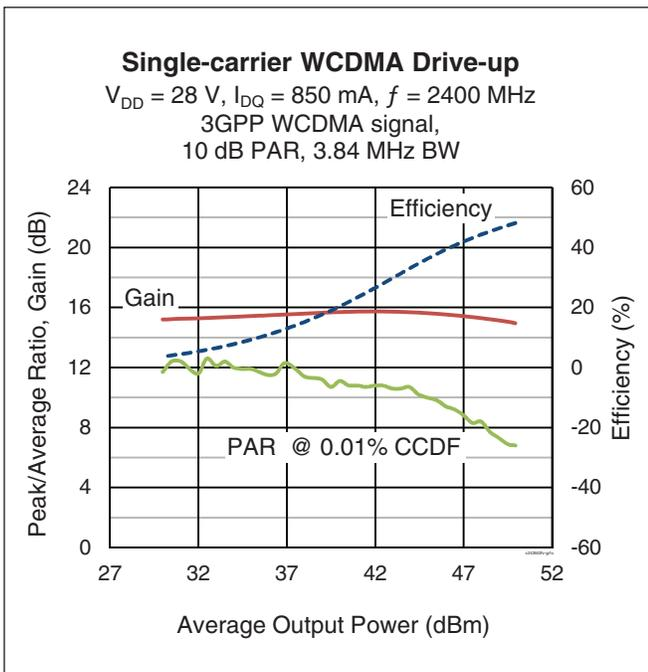
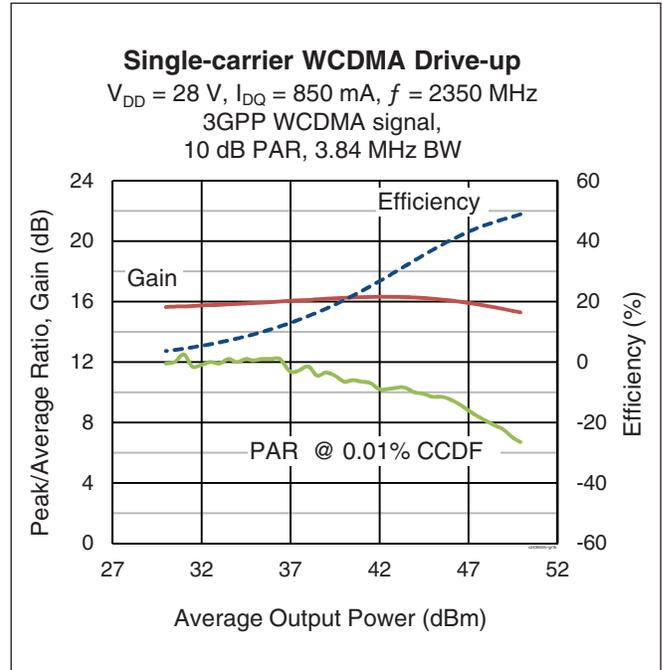
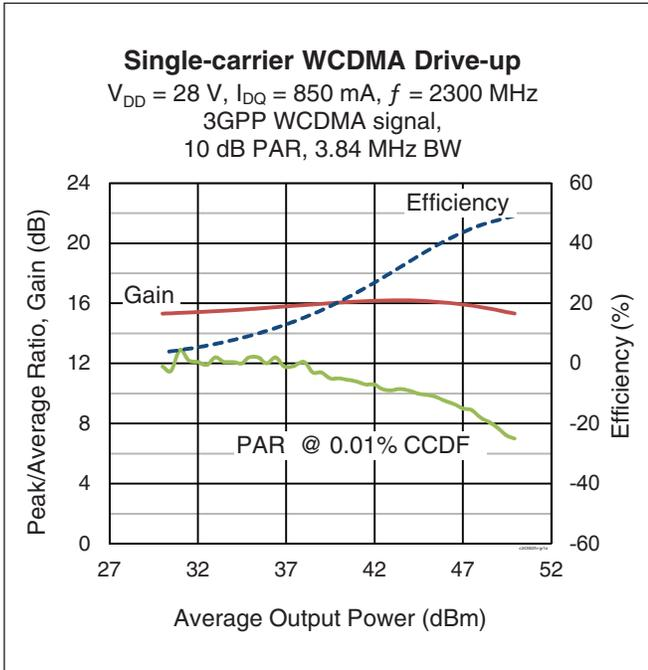

Typical RF Performance (cont.)

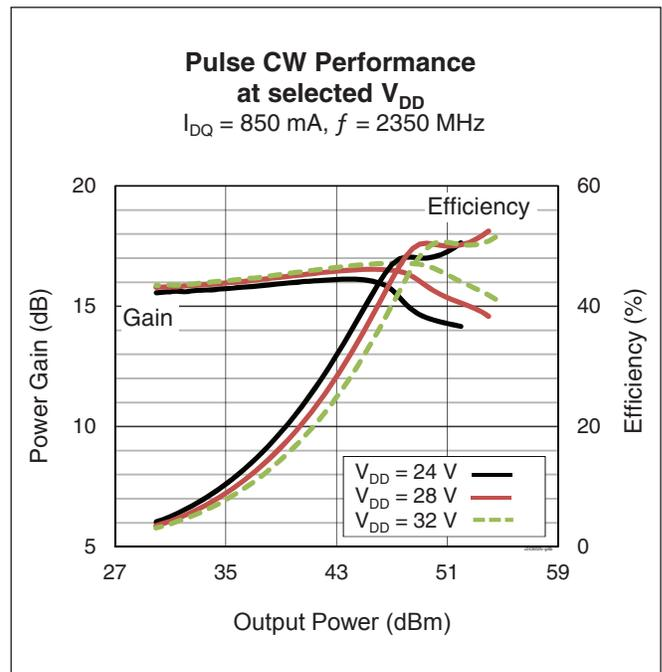
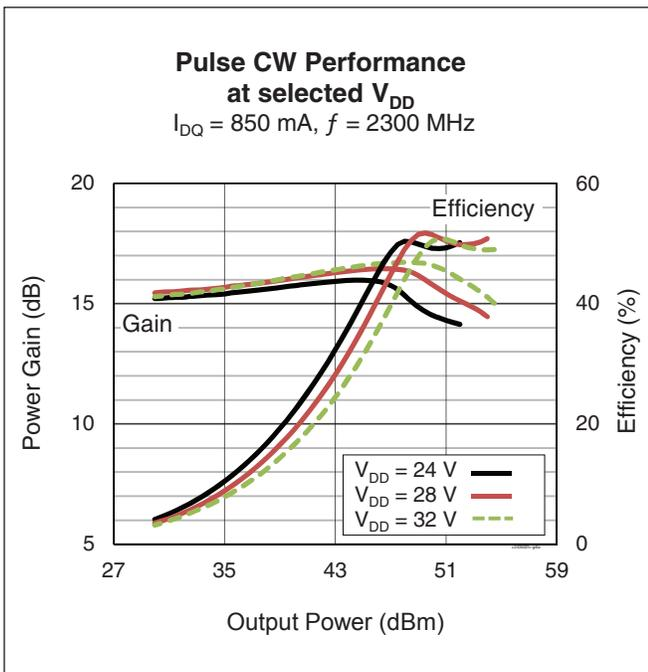
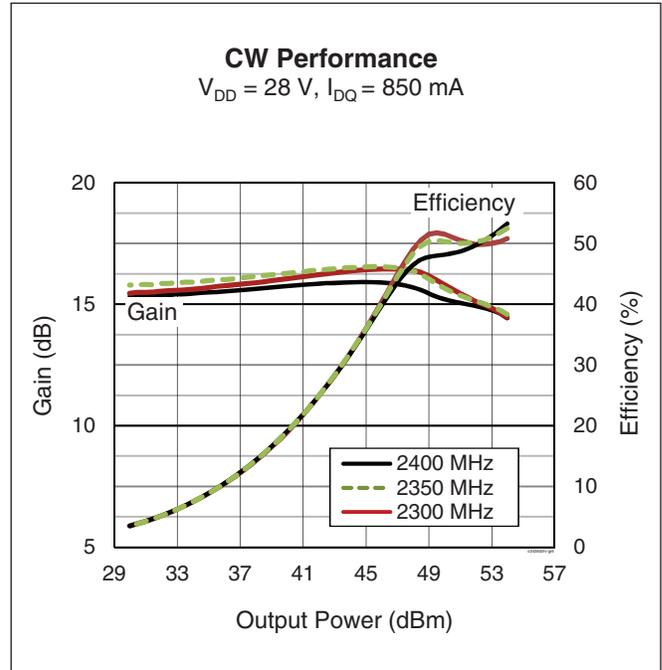
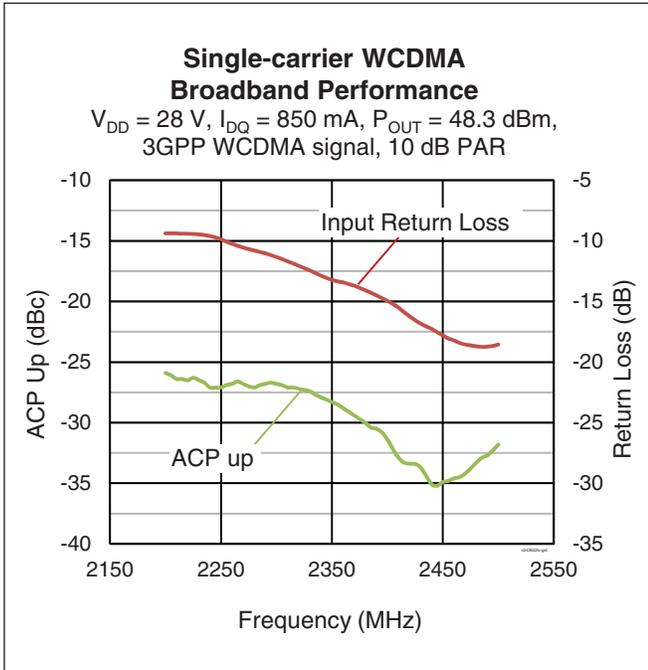

Typical RF Performance (cont.)

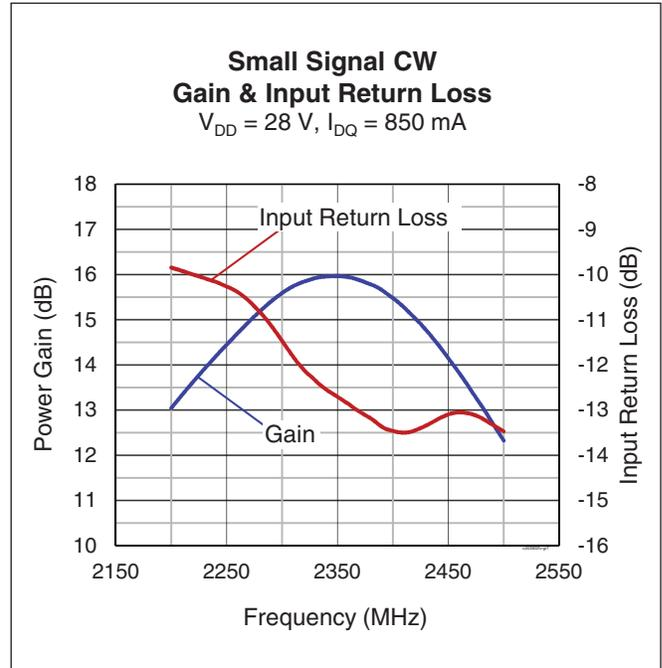
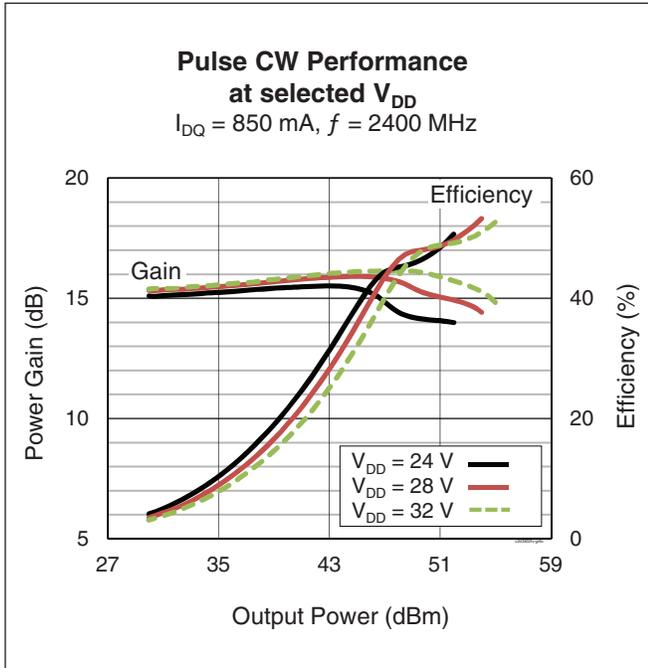

See next page for Load Pull Performance

Load Pull Performance

Main Side – Pulsed CW signal: 160 μ sec, 10% duty cycle; $V_{DD} = 28$ V, $I_{DQ} = 850$ mA

Class AB		P _{1dB}									
		Max Output Power					Max PAE				
Freq [MHz]	Z _s [Ω]	Z _l [Ω]	Gain [dB]	P _{OUT} [dBm]	P _{OUT} [W]	PAE [%]	Z _l [Ω]	Gain [dB]	P _{OUT} [dBm]	P _{OUT} [W]	PAE [%]
2300	6.82 – j9.56	1.28 – j3.64	16.16	52.39	173.38	49.67	2.37 – j2.28	18.79	50.39	109.47	59.01
2350	8.29 – j9.42	1.25 – j3.62	16.44	52.20	165.96	49.05	1.97 – j2.50	18.63	50.66	116.49	57.37
2400	10.06 – j7.29	1.30 – j3.61	16.46	51.82	152.05	45.61	1.99 – j2.24	18.90	50.15	103.49	54.87

Peak Side – Pulsed CW signal: 160 μ sec, 10% duty cycle; $V_{DD} = 28$ V, $I_{DQ} = 1350$ mA

Class AB		P _{1dB}									
		Max Output Power					Max PAE				
Freq [MHz]	Z _s [Ω]	Z _l [Ω]	Gain [dB]	P _{OUT} [dBm]	P _{OUT} [W]	PAE [%]	Z _l [Ω]	Gain [dB]	P _{OUT} [dBm]	P _{OUT} [W]	PAE [%]
2300	3.27 – j6.01	2.09 – j3.76	17.42	53.03	200.91	48.19	1.43 – j2.25	19.79	51.17	130.98	55.51
2350	4.08 – j6.00	2.03 – j3.86	17.54	52.77	189.23	45.76	1.33 – j2.63	19.82	51.31	135.33	53.60
2400	5.14 – j6.25	1.90 – j3.64	18.08	52.61	182.39	45.91	1.49 – j2.71	20.01	51.45	139.57	51.41

Peak Side – Pulsed CW signal: 160 μ sec, 10% duty cycle; $V_{DD} = 28$ V, $V_{GS(peak)} = 1.5$ V

Class C		P _{1dB}									
		Max Output Power					Max PAE				
Freq [MHz]	Z _s [Ω]	Z _l [Ω]	Gain [dB]	P _{OUT} [dBm]	P _{OUT} [W]	PAE [%]	Z _l [Ω]	Gain [dB]	P _{OUT} [dBm]	P _{OUT} [W]	PAE [%]
2300	3.27 – j6.01	1.67 – j4.02	12.90	53.71	234.96	50.13	1.42 – j2.66	14.27	52.51	178.28	59.99
2350	4.08 – j6.00	1.62 – j4.07	13.16	53.57	227.51	50.21	1.37 – j2.69	14.53	51.75	149.62	58.18
2400	5.14 – j6.25	1.96 – j4.15	13.39	53.43	220.29	48.66	1.47 – j2.71	14.74	51.79	150.83	56.64

Reference Circuit, 2300 to 2400 MHz

DUT	PXAC243502FV V1
Test Fixture Part No.	LTA/PXAC243502FV V1
PCB	Rogers 4350, 0.508 mm [.020"] thick, 2 oz. copper, $\epsilon_r = 3.66$
Find Gerber files for this reference fixture on the Infineon Web site at (http://www.infineon.com/rfpower)	

Reference Circuit (cont.)

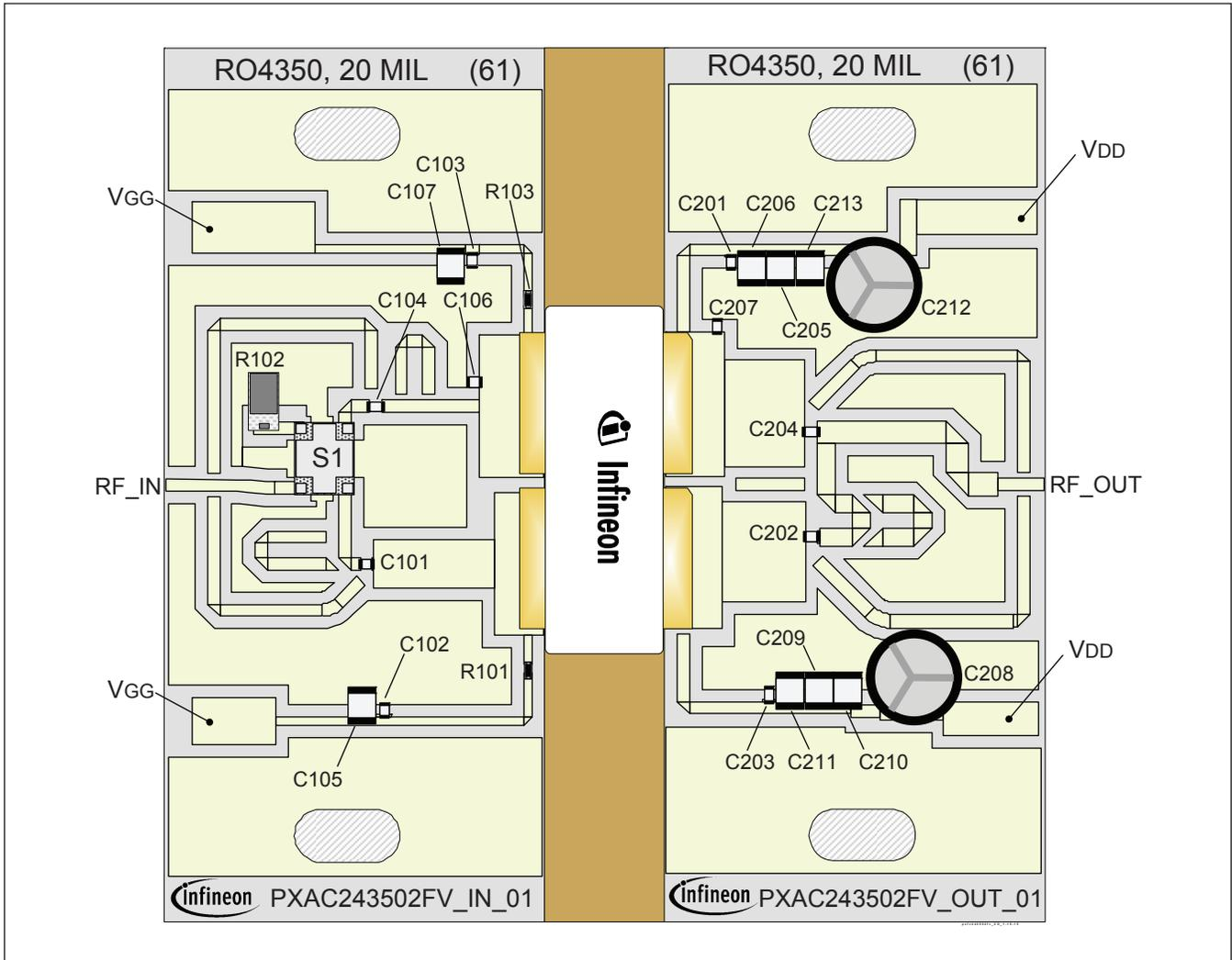

Reference circuit assembly diagram (not to scale)

Component Information

Component	Description	Manufacturer	Part Number
Input			
C101, C102, C103, C104	Capacitor, 15 pF	ATC	ATC600F150JT250XT
C105, C107	Capacitor, 10 μF	Taiyo Yuden	UMK325C7106MM-T
C106	Capacitor, 0.5 pF	ATC	ATC600F0R5BT250XT
R101, R103	Chip resistor, 10 ohms	Panasonic Electronic Components	ERJ-3GEYJ100V
R102	Chip resistor, 50 ohms	Anaren	C16A50Z4
S1	Hybrid coupler	Anaren	X3C25P1-02S

(table cont. next page)

Reference Circuit (cont.)

Component Information (cont.)

Component	Description	Manufacturer	Part Number
Output			
C201, C203	Capacitor, 15 pF	ATC	ATC600F150JT250XT
C207	Capacitor, 0.8 pF	ATC	ATC600F0R8BT250XT
C204	Capacitor, 3 pF	ATC	ATC600F3R0BT250XT
C202	Capacitor, 3.9 pF	ATC	ATC600F3R9BT250XT
C205, C206, C209, C210, C211, C213	Capacitor, 10 μ F	Taiyo Yuden	UMK325C7106MM-T
C212, C208	Capacitor, 220 μ F	Panasonic Electronic Components	EEE-FP1V221AP

Pinout Diagram (top view)

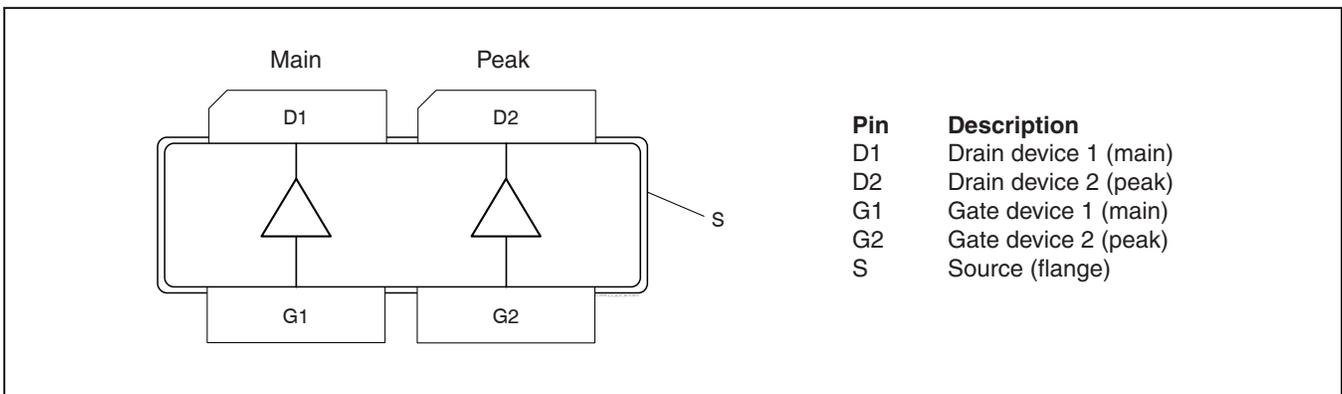

Package Outline Specifications

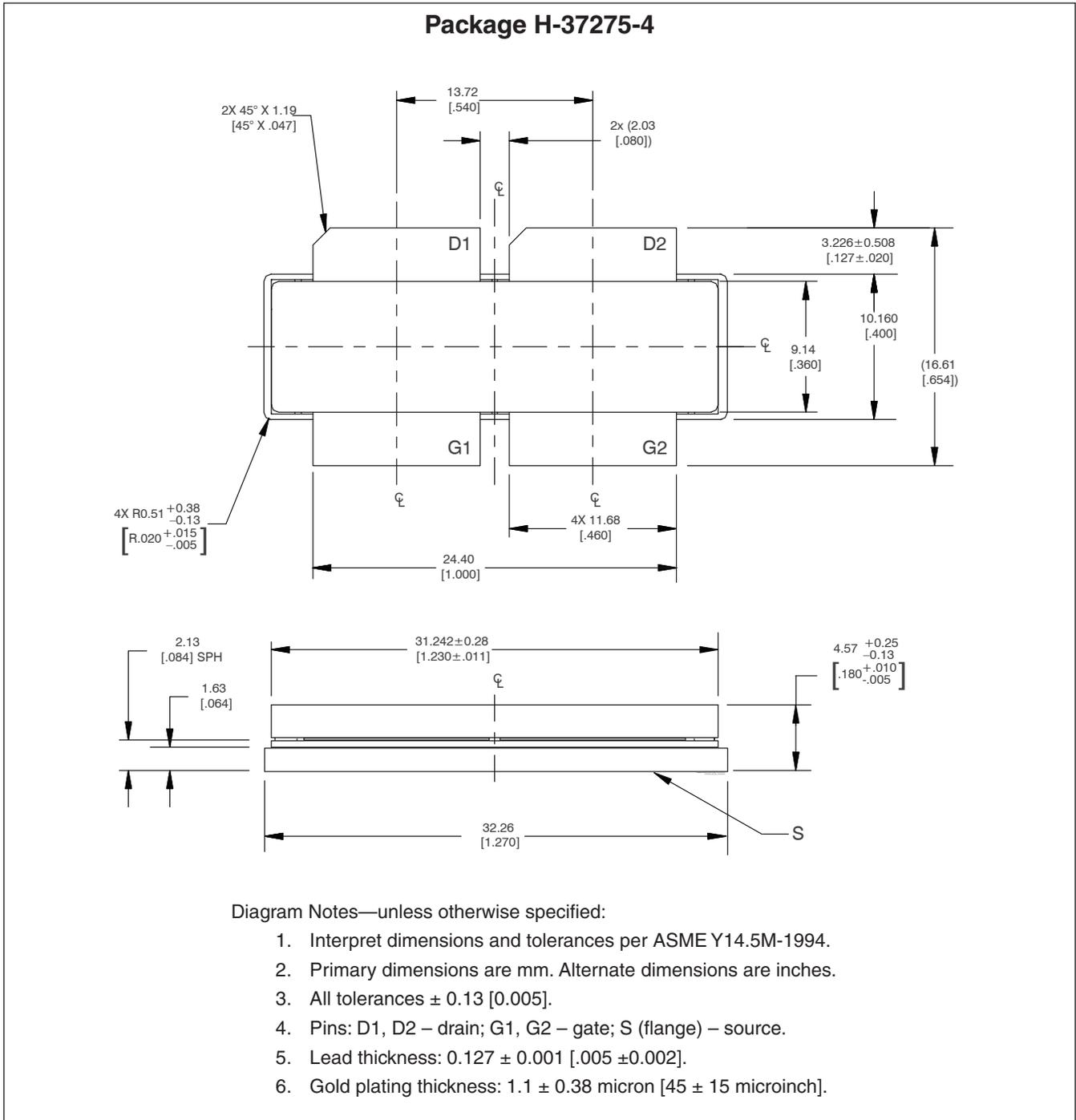

Find the latest and most complete information about products and packaging at the Infineon Internet page <http://www.infineon.com/rfpower>

Revision History

Revision	Date	Data Sheet	Page	Subjects (major changes at each revision)
01	2013-03-05	Advance	all	Proposed specification for new product development.
02	2014-12-24	Producton	all	Includes released-product specifications, including performance graphs and load pull data.
03	2015-01-16	Production	6 – 8	Include reference circuit information.
03.1	2015-04-13	Production	1, 2	Update RF and DC tables. Removed 1C WCDMA performance from Features, added HBM rating. Updated ordering table.
03.2	2016-06-22	Production	2	Updated ordering information

We Listen to Your Comments

Any information within this document that you feel is wrong, unclear or missing at all? Your feedback will help us to continuously improve the quality of this document. Please send your proposal (including a reference to this document) to:

highpowerRF@infineon.com

To request other information, contact us at:
 +1 877 465 3667 (1-877-GO-LDMOS) USA
 or +1 408 776 0600 International

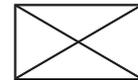

Edition 2016-06-22

**Published by
 Infineon Technologies AG
 85579 Neubiberg, Germany**

**© 2013 Infineon Technologies AG
 All Rights Reserved.**

Legal Disclaimer

The information given in this document shall in no event be regarded as a guarantee of conditions or characteristics. With respect to any examples or hints given herein, any typical values stated herein and/or any information regarding the application of the device, Infineon Technologies hereby disclaims any and all warranties and liabilities of any kind, including without limitation, warranties of non-infringement of intellectual property rights of any third party.

Information

For further information on technology, delivery terms and conditions and prices, please contact the nearest Infineon Technologies Office (www.infineon.com/rfpower).

Warnings

Due to technical requirements, components may contain dangerous substances. For information on the types in question, please contact the nearest Infineon Technologies Office.

Infineon Technologies components may be used in life-support devices or systems only with the express written approval of Infineon Technologies, if a failure of such components can reasonably be expected to cause the failure of that life-support device or system or to affect the safety or effectiveness of that device or system. Life support devices or systems are intended to be implanted in the human body or to support and/or maintain and sustain and/or protect human life. If they fail, it is reasonable to assume that the health of the user or other persons may be endangered.