

# Multilayer Chip Ferrite Bead – PZ Series

Operating Temp. : -55°C~+125°C

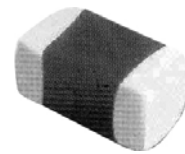

## FEATURES

- Internal silver printed layers and magnetic shielded structures to minimize crosstalk
- Large withstand current (allowable current: up to 6A)
- Can be used in a wide range of frequency to suppress EMI
- Three types material and wide range of impedance values for various applications

## APPLICATIONS

- Noise suppression for power line or large current signal of electric equipments such as computers and peripheral devices, DVD cameras, LCD TVs, communication equipments, OA equipments, etc.

## PRODUCT IDENTIFICATION

**PZ**

①  
①

Type	
PZ	Chip Ferrite Bead For Large Current

**1608**

②

**U**

③  
②

**121**

④

External Dimensions (L×W) (mm)	
0603 [0201]	0.6×0.3
1005 [0402]	1.0×0.5
1608 [0603]	1.6×0.8
2012 [0805]	2.0×1.25
3216 [1206]	3.2×1.6
4516 [1806]	4.5×1.6

**-1R0**

⑤

**T**

⑥

**F**

⑦

Material Code	
D, E, U	

⑤

Rated Current	
1R0	1.0A
2R5	2.5A
R60	0.6A

④

Nominal Impedance	
Example	Nominal Value
300	30Ω
121	120Ω
102	1000Ω

⑥

Packing	
T	Tape & Reel

⑦

Hazardous Substance Free Products	
F	

## SHAPE AND DIMENSIONS

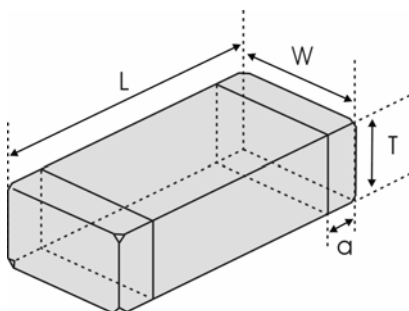

Unit: mm [inch]

Type	L	W	T	a
PZ0603 [0201]	0.6±0.05 [.024±.002]	0.3±0.05 [.012±.002]	0.3±0.05 [.012±.002]	0.15±0.05 [.006±.002]
PZ1005 [0402]	1.0±0.15 [.039±.006]	0.5±0.15 [.020±.006]	0.5±0.15 [.020±.006]	0.25±0.1 [.010±.004]
PZ1608 [0603]	1.6±0.15 [.063±.006]	0.8±0.15 [.031±.006]	0.8±0.15 [.031±.006]	0.3±0.2 [.012±.008]
PZ2012 [0805]	2.0 (+0.3, -0.1) [.079 (+.012, -.004)]	1.25±0.2 [.049±.008]	0.85±0.2 [.033±.008]	0.5±0.3 [.020±.012]
PZ3216 [1206]	3.2±0.2 [.126±.008]	1.6±0.2 [.063±.008]	0.85±0.2 [.033±.008]	0.5±0.3 [.020±.012]
			1.1±0.2 [.043±.008]	
PZ4516 [1806]	4.5±0.2 [.178±.008]	1.6±0.2 [.063±.008]	1.6±0.2 [.063±.008]	0.5±0.3 [.020±.012]

**Sunlord**

Specifications subject to change without notice. Please check our website for latest information. Released: 2011/03/15

Sunlord Industrial Park, Guangguang Road, Shenzhen, China Tel: 0755-29832660 Fax: 0755-82269029 Web: <http://www.sunlordinc.com> E-mail: [sunlord@sunlordinc.com](mailto:sunlord@sunlordinc.com)

## SPECIFICATIONS

### PZ0603 TYPE

Part Number	Impedance	Z Test Frequency	Max.DC Resistance	Max.Rated Current	Thickness
Units	$\Omega$	MHz	$\Omega$	mA	mm [inch]
Symbol	Z	Freq.	DCR	Ir	T
PZ0603D220-1R0TF	22±25%	100	0.065	1000	0.3±0.05
PZ0603D330-R75TF	33±25%	100	0.09	750	[.012±.002]

### PZ1005 TYPE

Part Number	Impedance	Z Test Frequency	Max.DC Resistance	Max.Rated Current	Thickness
Units	$\Omega$	MHz	$\Omega$	mA	mm [inch]
Symbol	Z	Freq.	DCR	Ir	T
PZ1005D100-1R0TF	0~30	100	0.05	1000	0.5±0.15 [.020±.006]
PZ1005E100-1R8TF	0~15	100	0.02	1800	
PZ1005E700-R80TF	70±25%	100	0.10	800	
PZ1005E121-R70TF	120±25%	100	0.13	700	
PZ1005E221-R60TF	220±25%	100	0.18	600	
PZ1005E601-R45TF	600±25%	100	0.34	450	
PZ1005U700-1R2TF	70±25%	100	0.10	1200	
PZ1005U121-1R0TF	120±25%	100	0.12	1000	
PZ1005U221-R80TF	220±25%	100	0.18	800	
PZ1005U601-R45TF	600±25%	100	0.34	450	

### PZ1608 TYPE

Part Number	Impedance	Z Test Frequency	Max. DC Resistance	Max. Rated Current	Thickness
Units	$\Omega$	MHz	$\Omega$	mA	mm [inch]
Symbol	Z	Freq.	DCR	Ir	T
PZ1608D300-3R0TF	30±25%	100	0.03	3000	0.8±0.15 [.031±.006]
PZ1608D600-2R0TF	60±25%	100	0.08	2000	
PZ1608D750-1R0TF	75±25%	100	0.15	1000	
PZ1608D121-1R0TF	120±25%	100	0.20	1000	
PZ1608D221-1R0TF	220±25%	100	0.20	1000	
PZ1608D601-R50TF	600±25%	100	0.35	500	
PZ1608E600-1R4TF	60±25%	100	0.10	1400	
PZ1608U100-3R0TF	0~15	100	0.02	3000	
PZ1608U300-3R0TF	30±25%	100	0.03	3000	
PZ1608U600-2R5TF	60±25%	100	0.04	2500	
PZ1608U121-2R0TF	120±25%	100	0.05	2000	
PZ1608U221-1R4TF	220±25%	100	0.10	1400	
PZ1608U331-1R2TF	330±25%	100	0.14	1200	
PZ1608U391-1R0TF	390±25%	100	0.14	1000	
PZ1608U471-1R0TF	470±25%	100	0.20	1000	

### PZ2012 TYPE

Part Number	Impedance	Z Test Frequency	Max. DC Resistance	Max. Rated Current	Thickness
Units	$\Omega$	MHz	$\Omega$	mA	mm [inch]
Symbol	Z	Freq.	DCR	Ir	T
PZ2012D390-4R0TF	39±25%	100	0.02	4000	0.85±0.2 [.033±.008]
PZ2012D800-3R0TF	80±25%	100	0.04	3000	
PZ2012D121-2R5TF	120±25%	100	0.06	2500	
PZ2012D221-1R5TF	220±25%	100	0.08	1500	
PZ2012D301-1R5TF	300±25%	100	0.12	1500	
PZ2012D471-R80TF	470±25%	100	0.25	800	

## SPECIFICATIONS

### PZ2012 TYPE

Part Number	Impedance	Z Test Frequency	Max. DC Resistance	Max. Rated Current	Thickness
Units	$\Omega$	MHz	$\Omega$	mA	mm [inch]
Symbol	Z	Freq.	DCR	Ir	T
PZ2012D601-R80TF	600±25%	100	0.25	800	0.85±0.2 [.033±.008]
PZ2012U300-3R0TF	30±25%	100	0.02	3000	
PZ2012U300-4R0TF	30±25%	100	0.015	4000	
PZ2012U600-3R0TF	60±25%	100	0.025	3000	
PZ2012U121-2R5TF	120±25%	100	0.04	2500	
PZ2012U221-2R0TF	220±25%	100	0.07	2000	
PZ2012U301-1R5TF	300±25%	100	0.10	1500	
PZ2012U421-1R0TF	420±25%	100	0.20	1000	
PZ2012U601-R80TF	600±25%	100	0.25	800	

### PZ3216 TYPE

Part Number	Impedance	Z Test Frequency	Max. DC Resistance	Max. Rated Current	Thickness
Units	$\Omega$	MHz	$\Omega$	mA	mm [inch]
Symbol	Z	Freq.	DCR	Ir	T
PZ3216D190-6R0TF	19±25%	100	0.010	6000	0.85±0.2 [.033±.008]
PZ3216D380-5R0TF	38±25%	100	0.015	5000	
PZ3216D600-4R0TF	60±25%	100	0.02	4000	
PZ3216D121-2R5TF	120±25%	100	0.04	2500	
PZ3216D501-2R0TF	500±25%	100	0.07	2000	
PZ3216D601-1R5TF	600±25%	100	0.10	1500	
PZ3216U300-6R0TF	30±25%	100	0.01	6000	
PZ3216U600-4R0TF	60±25%	100	0.025	4000	
PZ3216U121-3R0TF	120±25%	100	0.03	3000	
PZ3216U221-2R0TF	220±25%	100	0.08	2000	
PZ3216U301-2R0TF	300±25%	100	0.10	2000	
PZ3216U391-2R0TF	390±25%	100	0.07	2000	
PZ3216U601-1R5TF	600±25%	100	0.10	1500	
PZ3216U102-R50TF	1000±25%	100	0.30	500	

Note: The thickness of PZ3216 series may be increased to 1.1±0.2 mm when the Ir of product increased.

### PZ4516 TYPE

Part Number	Impedance	Z Test Frequency	Max. DC Resistance	Max. Rated Current	Thickness
Units	$\Omega$	MHz	$\Omega$	mA	mm [inch]
Symbol	Z	Freq.	DCR	Ir	T
PZ4516U600-6R0TF	60±25%	100	0.01	6000	1.6±0.2 [.063±.008]
PZ4516U720-6R0TF	72±25%	100	0.01	6000	
PZ4516U181-3R0TF	180±25%	100	0.025	3000	
PZ4516U471-2R0TF	470±25%	100	0.05	2000	

※: Products with other electrical characteristics can be provided upon customer's request. Please contact your local sales.

# TYPICAL ELECTRICAL CHARACTERISTICS

## D, E, U Material Comparison

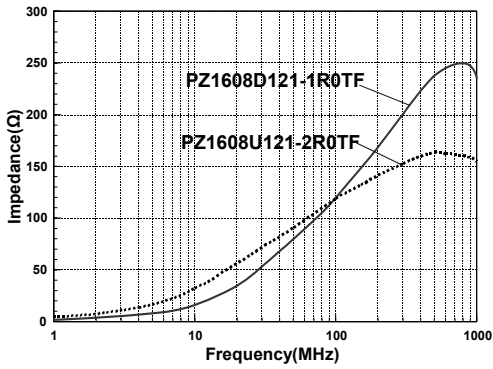

## Rated Current

When operating temperatures exceed +85°C, derating of current is necessary for chip ferrite beads for which rated current is 1000mA and over. Please apply the derating curve shown in chart according to the operating temperature.

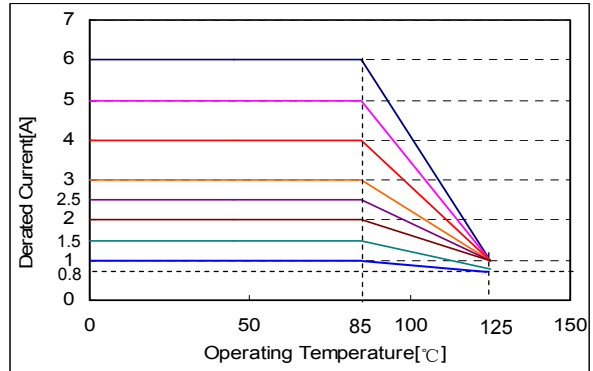

# DETAIL ELECTRICAL CHARACTERISTICS

## PZ0603 TYPE

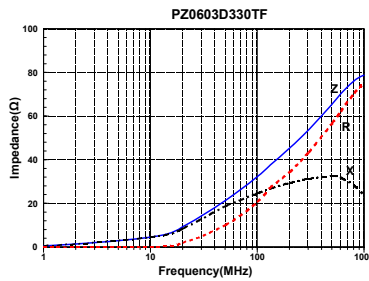
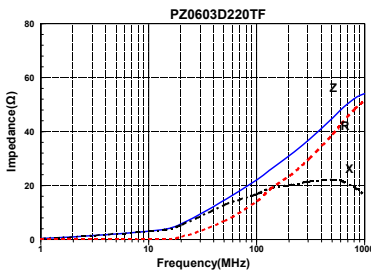

## PZ1005 TYPE

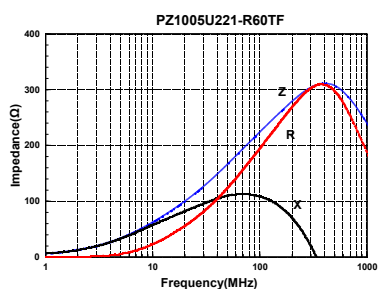
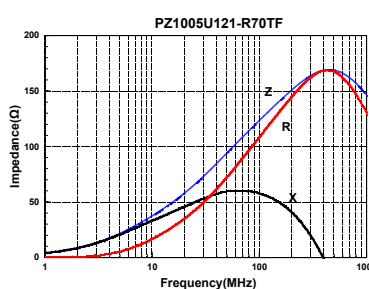
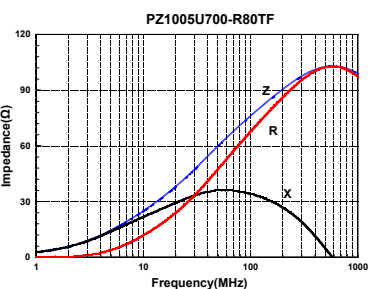
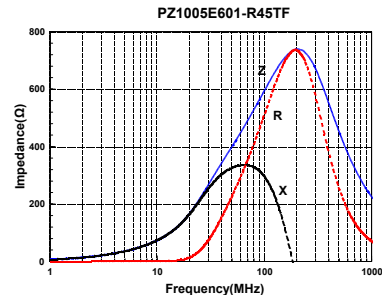
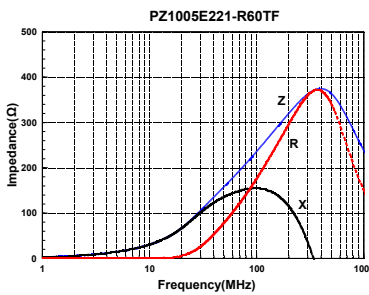
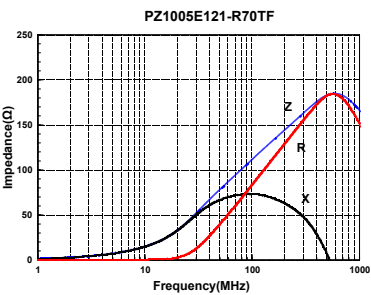
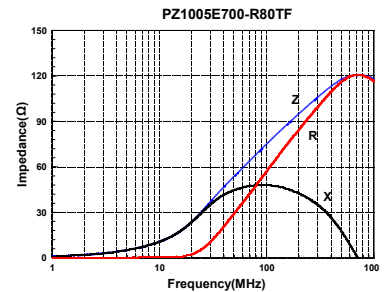
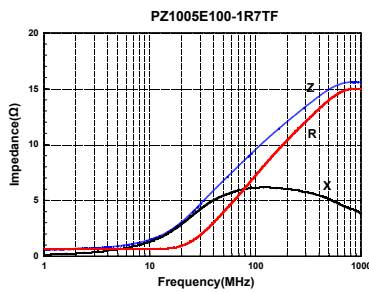
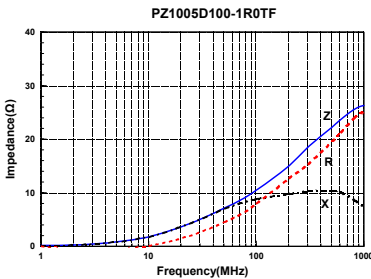

Specifications subject to change without notice. Please check our website for latest information. Released: 2011/03/15

# DETAIL ELECTRICAL CHARACTERISTICS

## PZ1005 TYPE

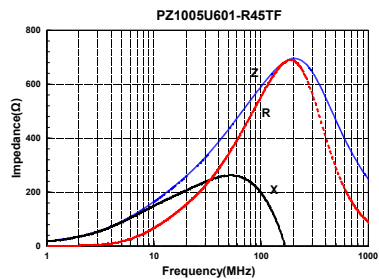

## PZ1608 TYPE

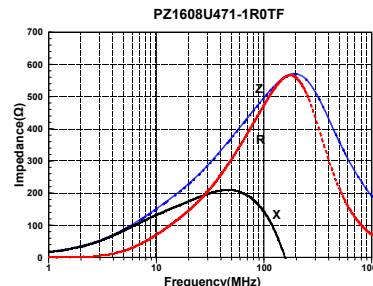
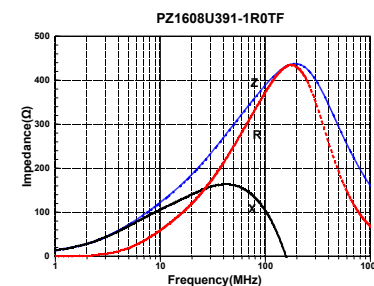
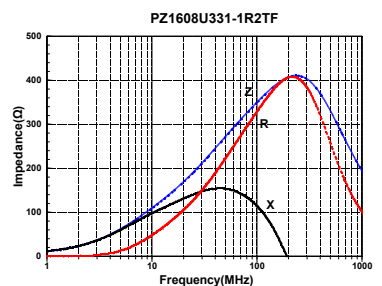
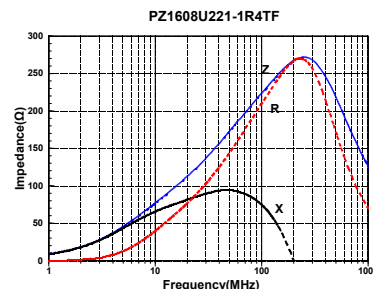
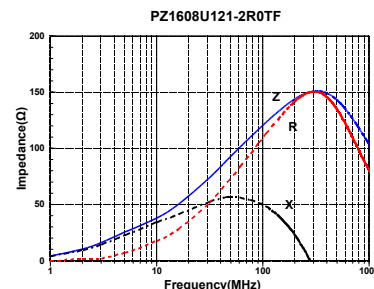
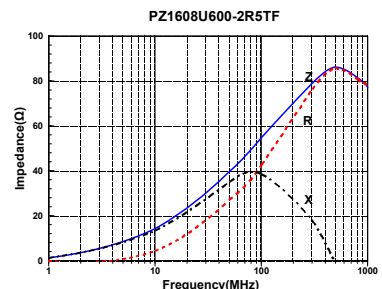
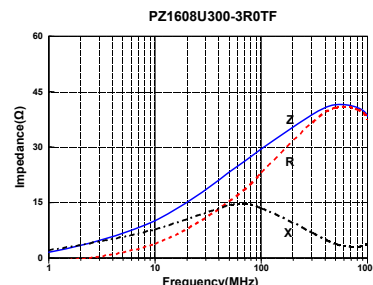
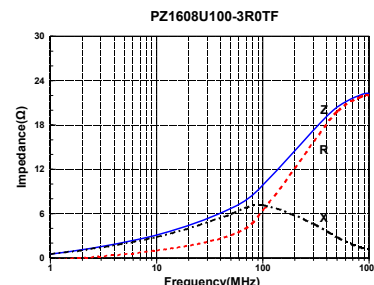
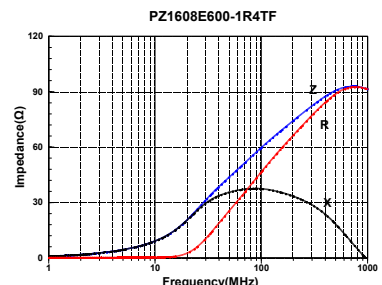
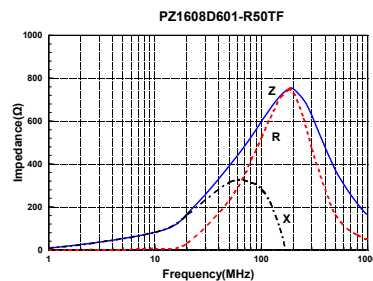
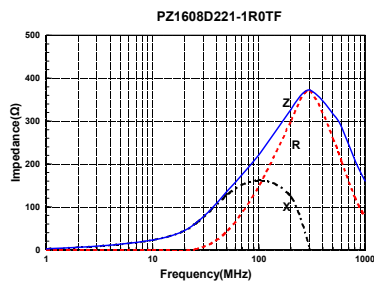
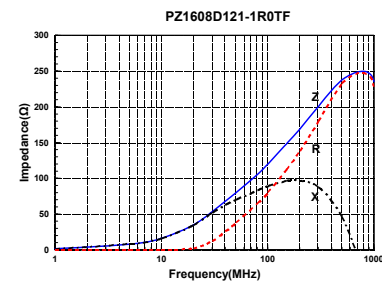
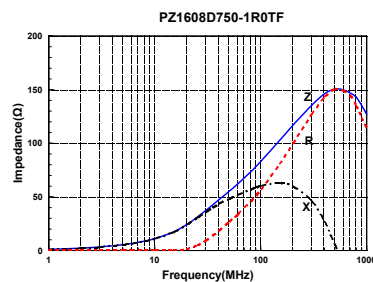
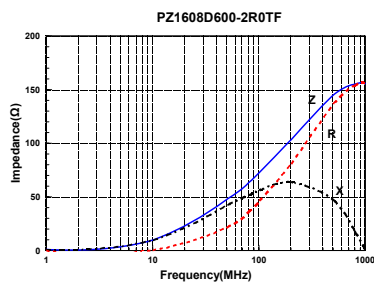
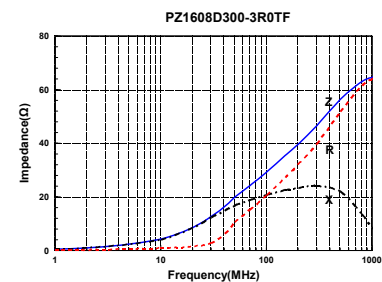

Specifications subject to change without notice. Please check our website for latest information. Released: 2011/03/15

# DETAIL ELECTRICAL CHARACTERISTICS

## PZ2012 TYPE

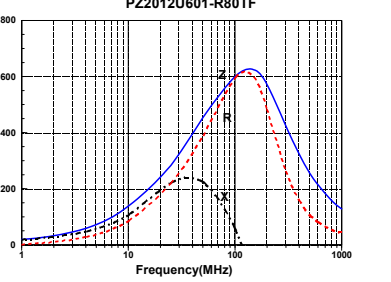
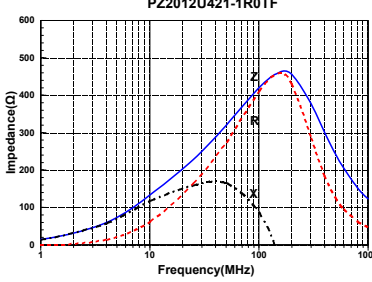
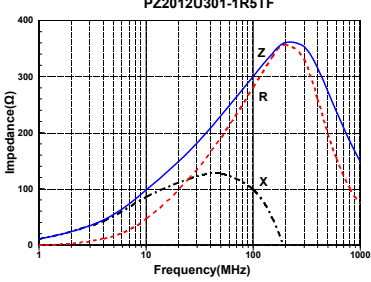
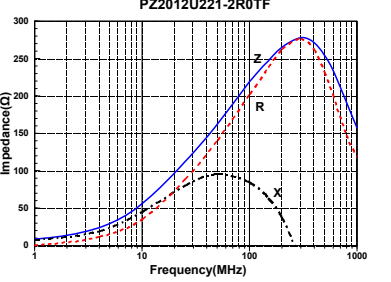
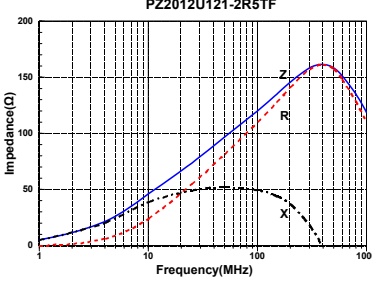
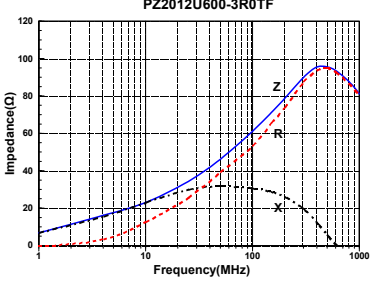
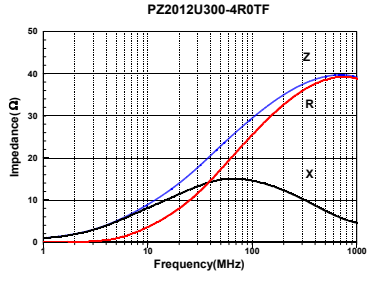
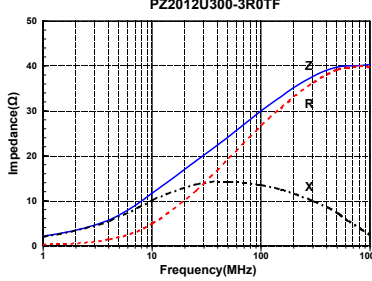
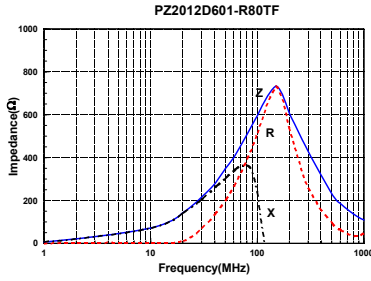
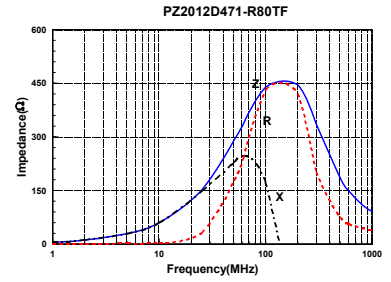
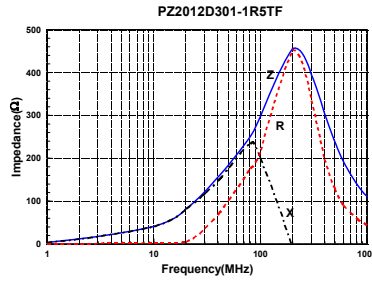
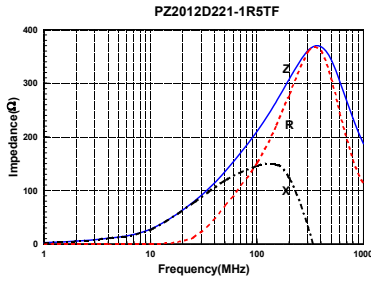
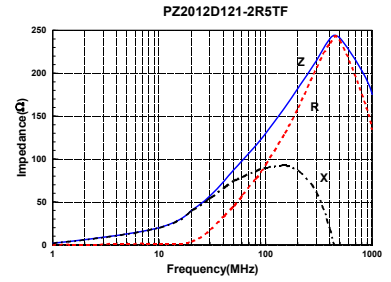
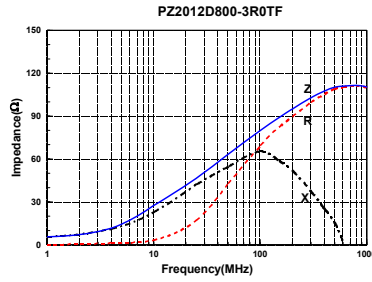
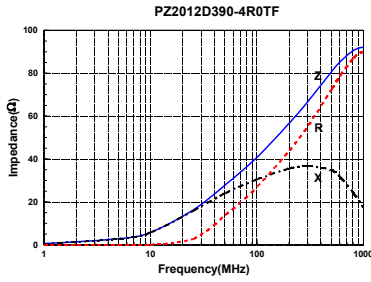

## PZ3216 TYPE

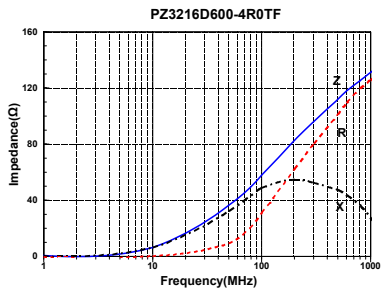
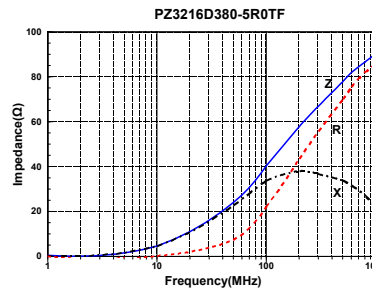
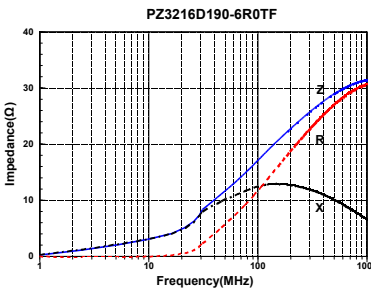

# DETAIL ELECTRICAL CHARACTERISTICS

## PZ3216 TYPE

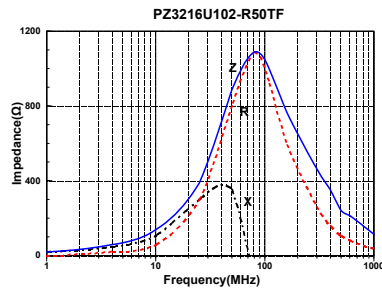
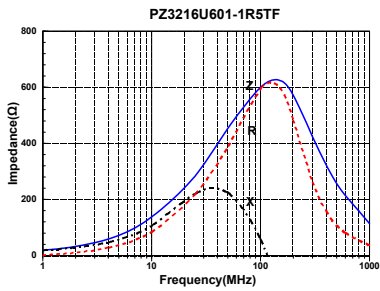
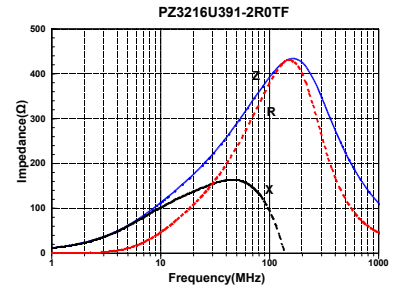
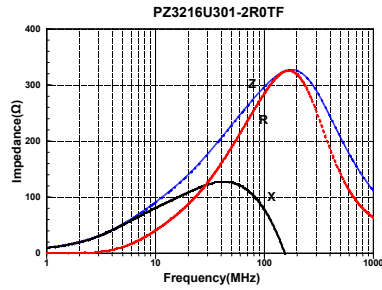
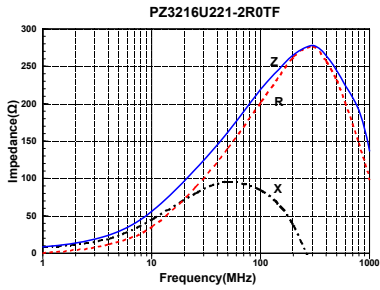
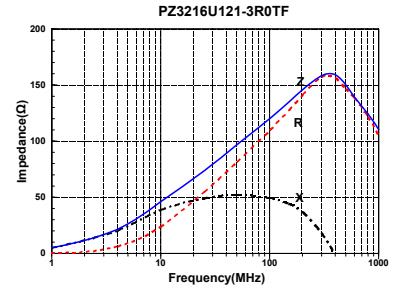
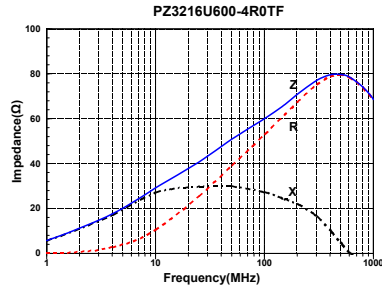
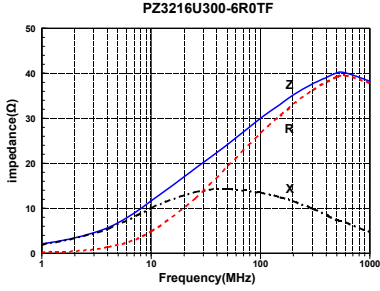
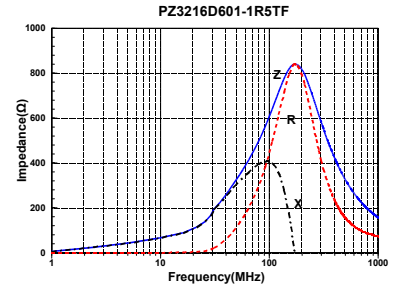
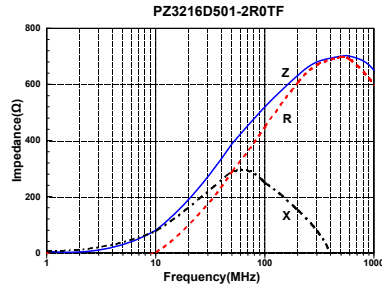
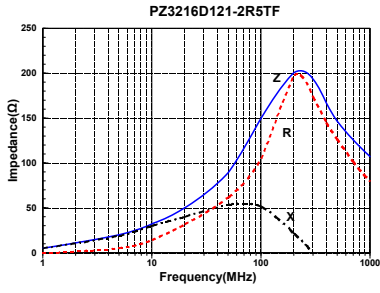

## PZ4516 TYPE

