

### PNP Silicon Planar Epitaxial Transistor

**(Pb)** Lead(Pb)-Free

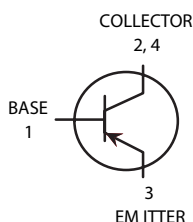

#### SOT-223

1.BASE  
2.COLLECTOR  
3.EMITTER  
4.COLLECTOR

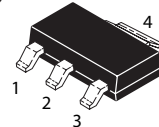

### ABSOLUTE MAXIMUM RATINGS (Ta=25°C)

Rating	Symbol	Value	Unit
Collector-Emitter Voltage	V <sub>CEO</sub>	-60	Vdc
Collector-Base Voltage	V <sub>CBO</sub>	-60	Vdc
Emitter-Base Voltage	V <sub>EBO</sub>	-5.0	Vdc
Collector Current (DC)	I <sub>C(DC)</sub>	-600	mAdc
Total Device Dissipation T <sub>A</sub> =25°C	P <sub>D</sub>	1.5	W
Junction Temperature	T <sub>j</sub>	150	°C
Storage, Temperature	T <sub>stg</sub>	-55 to +150	°C

### Device Marking

PZT2907A=2907A

### ELECTRICAL CHARACTERISTICS

Characteristics	Symbol	Min	Max	Unit
Collector-Emitter Breakdown Voltage (I <sub>C</sub> = -10 mAdc, I <sub>B</sub> =0)	V <sub>(BR)CEO</sub>	-60	-	Vdc
Collector-Base Breakdown Voltage (I <sub>C</sub> =-10 μAdc, I <sub>E</sub> =0)	V <sub>(BR)CBO</sub>	-60	-	Vdc
Emitter-Base Breakdown Voltage (I <sub>E</sub> = -10 μAdc, I <sub>C</sub> =0)	V <sub>(BR)EBO</sub>	-5.0	-	Vdc
Base-Emitter Cutoff Current (V <sub>CE</sub> = 60 Vdc, V <sub>BE</sub> =-3.0Vdc)	I <sub>BEX</sub>	-	20	nAdc
Collector-Emitter Cutoff Current (V <sub>CE</sub> = -30 Vdc, V <sub>BE</sub> =-0.5 Vdc)	I <sub>CEX</sub>	-	-50	nAdc
Emitter-Base Cutoff Current (V <sub>EB</sub> = 3.0Vdc, I <sub>C</sub> =0)	I <sub>EBO</sub>	-	100	nAdc

NOTE: 1.Device mounted on an epoxy printed circuit board 1.575 inches×1.575 inches×0.059 inches; mounting pad for the collector lead min. 0.93 inches<sup>2</sup>

**ELECTRICAL CHARACTERISTICS— Continued** ( $T_A = 25^\circ\text{C}$  unless otherwise noted)

Characteristic	Symbol	Min	TYP	Max	Unit
----------------	--------	-----	-----	-----	------

**ON CHARACTERISTICS**

DC Current Gain ( $I_C = -100\text{ mAdc}$ , $V_{CE} = -10\text{ Vdc}$ ) ( $I_C = -1.0\text{ mAdc}$ , $V_{CE} = -10\text{ Vdc}$ ) ( $I_C = -10\text{ mAdc}$ , $V_{CE} = -10\text{ Vdc}$ ) ( $I_C = -150\text{ mAdc}$ , $V_{CE} = -10\text{ Vdc}$ ) ( $I_C = -500\text{ mAdc}$ , $V_{CE} = -10\text{ Vdc}$ )	$h_{FE1}$ $h_{FE2}$ $h_{FE3}$ $h_{FE4}$ $h_{FE5}$	75 100 100 100 50	- - - 180 -	- - - 300 -	-
Collector-Emitter Saturation Voltages ( $I_C = -150\text{ mAdc}$ , $I_B = -15\text{ mAdc}$ ) ( $I_C = -500\text{ mAdc}$ , $I_B = -50\text{ mAdc}$ )	$V_{CE(sat)}$	- -	-0.2 -0.5	-0.4 -1.6	Vdc
Base-Emitter Saturation Voltages ( $I_C = -150\text{ mAdc}$ , $I_B = -15\text{ mAdc}$ ) ( $I_C = -500\text{ mAdc}$ , $I_B = -50\text{ mAdc}$ )	$V_{BE(sat)}$	- -	- -	-1.3 -2.6	Vdc

**DYNAMIC CHARACTERISTICS**

Current-Gain—Bandwidth Product ( $I_C = -50\text{ mAdc}$ , $V_{CE} = -20\text{ Vdc}$ , $f = 100\text{ MHz}$ )	$f_T$	200	-	-	MHz
Output Capacitance ( $V_{CB} = -10\text{ Vdc}$ , $I_E = 0$ , $f = 1.0\text{ MHz}$ )	$C_c$	-	-	8.0	pF
Input Capacitance ( $V_{EB} = -2.0\text{ Vdc}$ , $I_C = 0$ , $f = 1.0\text{ MHz}$ )	$C_e$	-	-	30	pF

**SWITCHING TIMES** ( $T_A = 25^\circ\text{C}$ )

Turn-On Time	$(V_{CC} = -30\text{ Vdc}$ , $I_C = -150\text{ mAdc}$ , $I_{B1} = -15\text{ mAdc}$ )	$t_{on}$	-	-	45	ns
Delay Time		$t_d$	-	-	10	
Rise Time		$t_r$	-	-	40	
Turn-Off Time	$(V_{CC} = -6.0\text{ Vdc}$ , $I_C = -150\text{ mAdc}$ , $I_{B1} = I_{B2} = -15\text{ mAdc}$ )	$t_{off}$	-	-	100	ns
Storage Time		$t_s$	-	-	80	
Fall Time		$t_f$	-	-	30	

 2. Pulse Test: Pulse Width  $\leq 300\mu\text{s}$ , Duty Cycle  $\leq 2.0\%$

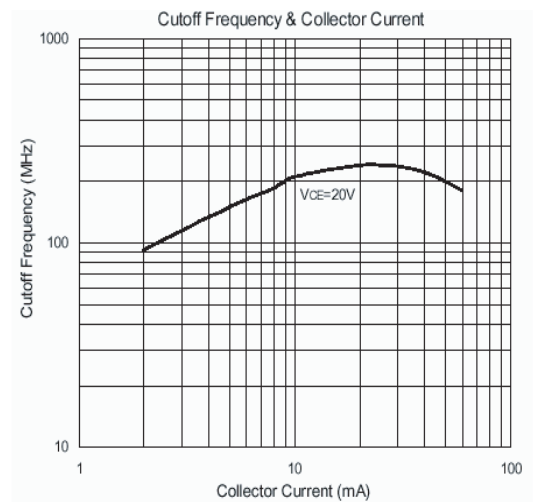
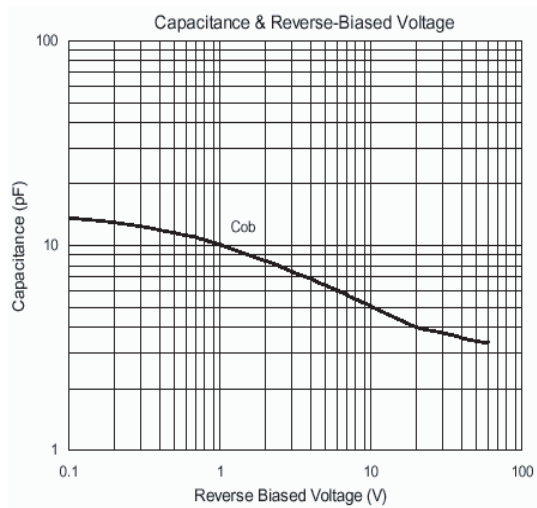
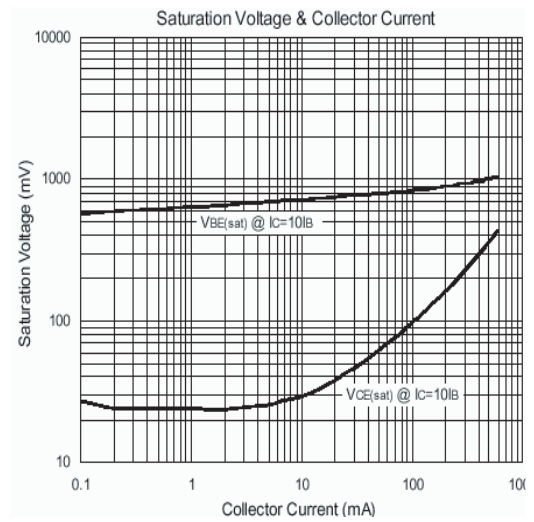
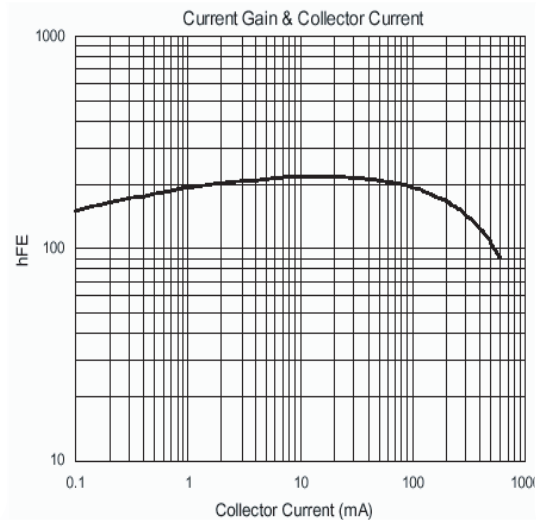

## SOT-223 Outline Dimensions

unit:mm

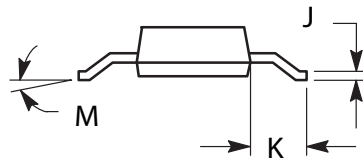
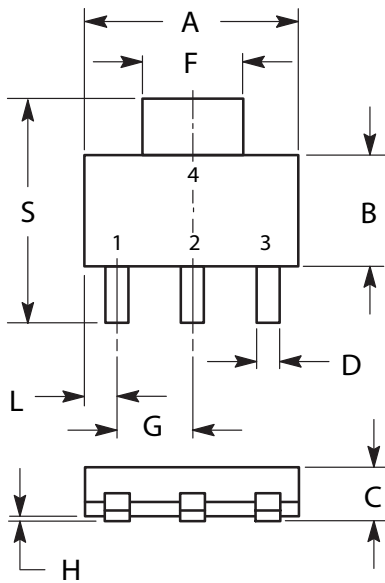

DIM	MILLIMETERS	
	MIN	MAX
A	6.30	6.70
B	3.30	3.70
C	1.50	1.75
D	0.60	0.89
F	2.90	3.20
G	2.20	2.40
H	0.020	0.100
J	0.24	0.35
K	1.50	2.00
L	0.85	1.05
M	0°	10°
S	6.70	7.30