

UTCPZTA44/45 NPN EPITAXIAL SILICON TRANSISTOR

HIGH VOLTAGE TRANSISTOR

FEATURES

- *Collector-Emitter voltage:
 V_{CEO}=400V(PZTA44)
 V_{CEO}=350V(PZTA45)
- *Collector current up to 300mA
- *Complement to PZTA94/93
- *Collector Dissipation:
 P_{c(max)}=2W

APPLICATION

- *Telephone switching
- *High voltage switch

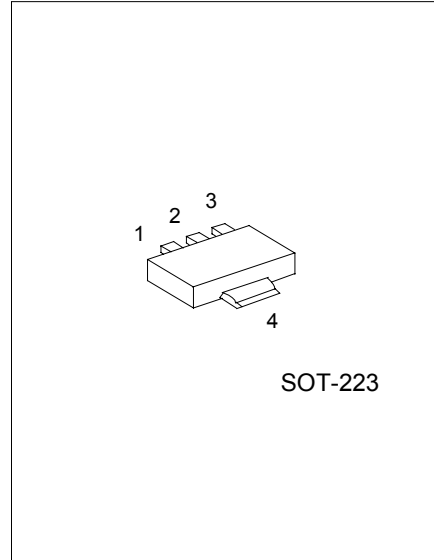

1:EMITTER 2,4:COLLECTOR 3:BASE

ABSOLUTE MAXIMUM RATINGS (Operating temperature range applies unless otherwise specified)

PARAMETER	SYMBOL	RATING	UNIT
Collector-base voltage PZTA44 PZTA45	V _{CB0}	500 400	V
Collector-emitter voltage PZTA44 PZTA45	V _{CEO}	400 350	V
Emitter-base voltage	V _{EB0}	6	V
Collector dissipation(T _a =25°C)	P _c	625	mW
Collector dissipation(T _c =25°C)	P _c	2	W
Collector current	I _c	300	mA
Junction Temperature	T _j	150	°C
Storage Temperature	T _{STG}	-55 ~ +150	°C

UTCPZTA44/45 NPN EPITAXIAL SILICON TRANSISTOR

ELECTRICAL CHARACTERISTICS (T_j=25°C, unless otherwise specified)

PARAMETER	SYMBOL	TEST CONDITIONS	MIN	TYP	MAX	UNIT
Collector-base breakdown voltage PZTA44 PZTA45	BVCBO	I _c =100μA, I _B =0	500 400			V
Collector-emitter breakdown voltage PZTA44 PZTA45	BVCEO	I _c =1mA, I _B =0	400 350			V
Emitter-base breakdown voltage	BVEBO	I _E =100μA, I _C =0	6			V
Collector cut-off current PZTA44 PZTA45	I _{CBO}	V _{CB} =400V, I _E =0 V _{CB} =320V, I _E =0			0.1 0.1	μA
Collector cut-off current PZTA44 PZTA45	I _{CES}	V _{CE} =400V, I _B =0 V _{CE} =320V, I _B =0			0.5 0.5	μA
Emitter cut-off current	I _{EBO}	V _{EB} =4V, I _C =0			0.1	μA
DC current gain(note)	h _{FE}	V _{CE} =10V, I _C =1mA V _{CE} =10V, I _C =10mA V _{CE} =10V, I _C =50mA V _{CE} =10V, I _C =100mA	40 50 45 40		240	
Collector-emitter saturation voltage	V _{CE(sat)}	I _c =1mA, I _B =0.1mA I _c =10mA, I _B =1mA I _c =50mA, I _B =5mA			0.4 0.5 0.75	V
Base-emitter saturation voltage	V _{BE(sat)}	I _c =10mA, I _B =1mA			0.75	V
Current gain bandwidth product	f _T	V _{CE} =20V, I _C =10mA, f=100MHz	50			MHz
Output capacitance	C _{ob}	V _{CB} =20V, I _E =0 f=1MHz			7	pF

Note: Pulse test: PW<300μs, Duty Cycle<2%

UTCPZTA44/45 NPN EPITAXIAL SILICON TRANSISTOR

TYPICAL CHARACTERISTIC CURVES

Fig.1 DC current gain

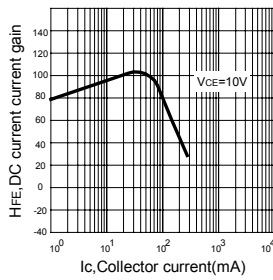

Fig.2 Turn-on switching times

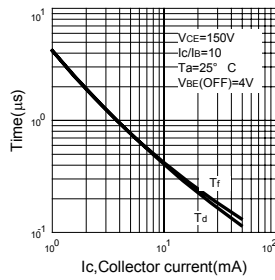

Fig.3 Turn-off switching times

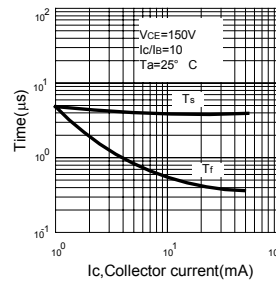

Fig.4 Capacitance

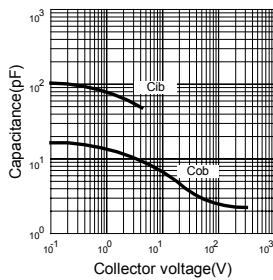

Fig.5 ON Voltage

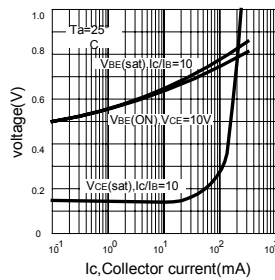

Fig.6 Collector saturation region

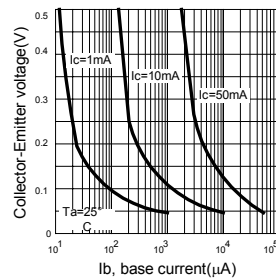

Fig.7 High Frequency current gain

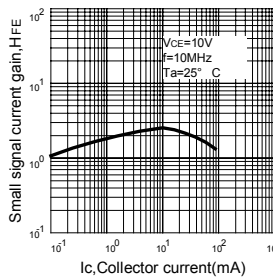
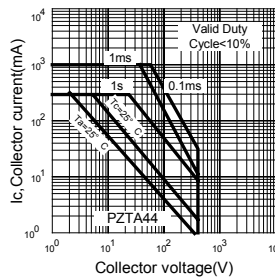

Fig.8 Safe operating area



UTC PZTA44/45 NPN EPITAXIAL SILICON TRANSISTOR

UTC assumes no responsibility for equipment failures that result from using products at values that exceed, even momentarily, rated values (such as maximum ratings, operating condition ranges, or other parameters) listed in products specifications of any and all UTC products described or contained herein. UTC products are not designed for use in life support appliances, devices or systems where malfunction of these products can be reasonably expected to result in personal injury. Reproduction in whole or in part is prohibited without the prior written consent of the copyright owner. The information presented in this document does not form part of any quotation or contract, is believed to be accurate and reliable and may be changed without notice.