

High-Voltage PNP Transistor Surface Mount

 Lead(Pb)-Free

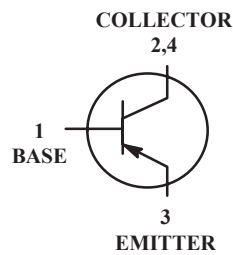

1.BASE
2.COLLECTOR
3.EMITTER
4.COLLECTOR

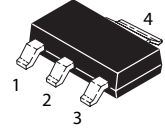

SOT-223

Maximum Ratings

Rating	Symbol	Value	Unit
Collector-Emitter Voltage	V_{CEO}	-300	Vdc
Collector-Base Voltage	V_{CBO}	-300	Vdc
Emitter-Base Voltage	V_{EBO}	-5.0	Vdc
Collector Current-Continuous	I_C	-500	mAdc
Total Device Dissipation	P_D	2.0	W
Junction and Storage, Temperature	T_J, T_{stg}	-55 to +150	°C

Device Marking

PZTA92 = A92

Electrical Characteristics ($T_A=25^\circ\text{C}$ Unless Otherwise noted)

Characteristics	Symbol	Min	Max	Unit
-----------------	--------	-----	-----	------

Off Characteristics

Collector-Emitter Breakdown Voltage ($I_C=-1.0\text{mAdc}$, $I_B=0$)	$V_{(BR)CEO}$	-300	-	Vdc
Collector-Base Breakdown Voltage ($I_C=-100\mu\text{Adc}$, $I_E=0$)	$V_{(BR)CBO}$	-300	-	Vdc
Emitter-Base Breakdown Voltage ($I_E=-100\mu\text{Adc}$, $I_C=0$)	$V_{(BR)EBO}$	-5.0	-	Vdc
Collect Cutoff Current ($V_{CB}=-200\text{Vdc}$, $I_E=0$)	I_{CBO}	-	-0.25	μAdc
Emitte Cutoff Current ($V_{EB}=-3\text{V}$, $I_C=0$)	I_{EBO}	-	-0.1	μAdc

Electrical Characteristics ($T_A=25^\circ\text{C}$ unless otherwise noted) (Continued)

Characteristics	Symbol	Min	Max	Unit
-----------------	--------	-----	-----	------

On Characteristics

DC Current Gain ($I_C = -1.0\text{ mAdc}, V_{CE} = -10\text{Vdc}$) ($I_C = -10\text{ mAdc}, V_{CE} = -10\text{Vdc}$) ($I_C = -30\text{ mAdc}, V_{CE} = -10\text{Vdc}$)	$H_{FE}(1)$ $H_{FE}(2)$ $H_{FE}(3)$	25 40 25	- - -	-
Collector-Emitter Saturation Voltage ($I_C = -20\text{ mAdc}, I_B = -2.0\text{mAdc}$)	$V_{CE(sat)}$	-	0.5	Vdc
Base-Emitter Saturation Voltage ($I_C = -20\text{ mAdc}, I_B = -2.0\text{ mAdc}$)	$V_{BE(sat)}$	-	0.9	Vdc
Current-Gain-Bandwidth Product ($I_C = -10\text{ mAdc}, V_{CE} = -20\text{Vdc}, f = 100\text{MHz}$)	f_T	50	-	MHz

Characteristics Curve

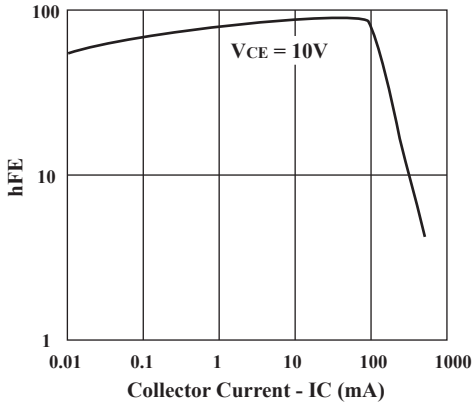

Fig.1 Current Gain & Collector Current

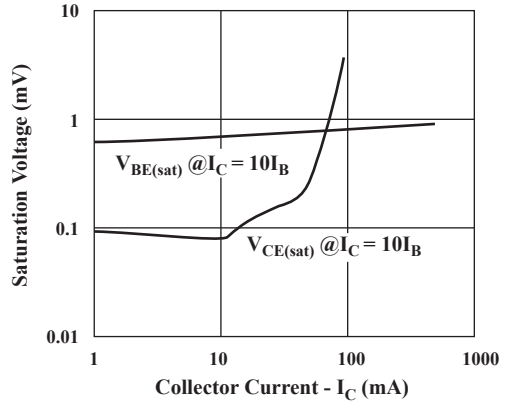

Fig.2 Saturation Voltage & Collector Current

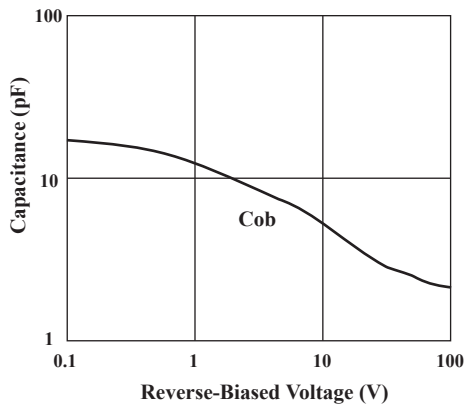

Fig.3 Capacitance & Reverse-Biased Voltage

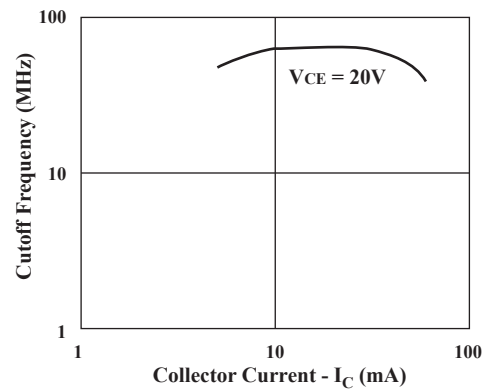

Fig.4 Cutoff Frequency & Collector Current

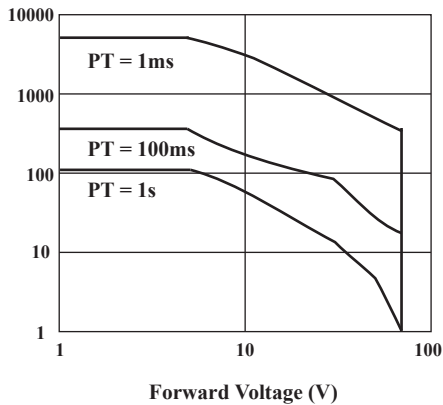
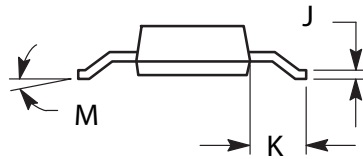
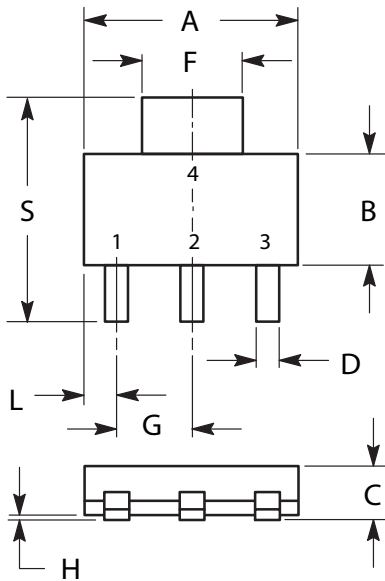

Fig.5 Safe Operating Area

SOT-223 Outline Dimensions

unit:mm



DIM	MILLIMETERS	
	MIN	MAX
A	6.30	6.70
B	3.30	3.70
C	1.50	1.75
D	0.60	0.89
F	2.90	3.20
G	2.20	2.40
H	0.020	0.100
J	0.24	0.35
K	1.50	2.00
L	0.85	1.05
M	0°	10°
S	6.70	7.30