

GaAs MMIC

- Tri mode power amplifier for AMPS/ CDMA /TDMA portable cellular phones
- 31 dBm saturated output power @ **PAE**=55% typ.
29 dBm linear output power @ **PAE**=40% typ.
- Fully integrated 2 stage amplifier
- Power ramp control
- Input matched to 50 ohms, simple output match

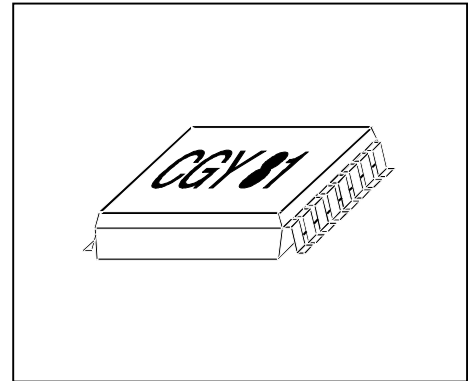

ESD: **E**lectrostatic **d**ischarge sensitive device, observe handling precautions!

Type	Marking	Ordering code (taped)	Package
CGY 81	CGY 81	Q627002G0078	MW 16

Maximum Ratings

Characteristics	Symbol	max. Value	Unit
Positive supply voltage	V_D	9	V
Supply current	I_D	4	A
Channel temperature	T_{Ch}	150	°C
Storage temperature	T_{stg}	-55...+150	°C
Pulse peak power dissipation	$PPulse$	tbd	W
Total power dissipation ($T_s \leq 80\text{ °C}$) <i>T_s: Temperature at soldering point</i>	P_{tot}	Tbd	W

Thermal Resistance

Characteristics	Symbol	max. Value	Unit
Channel-soldering point	R_{thChS}	11	K/W

Functional Block Diagram:

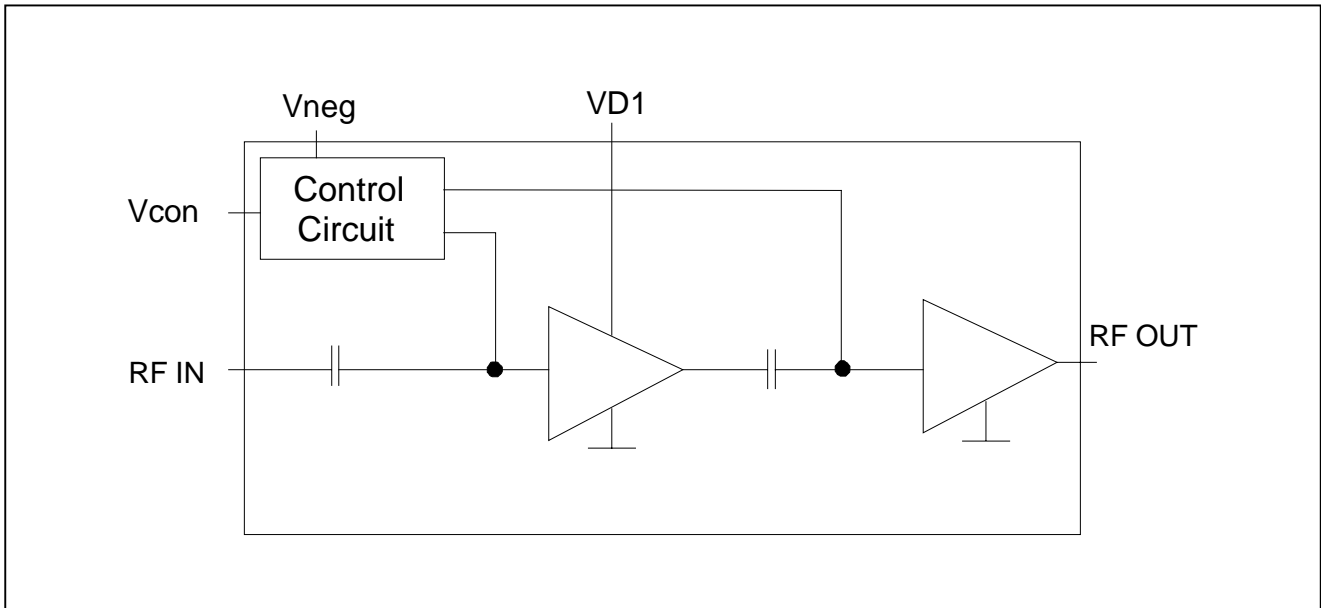

Pin Configuration:

Pin #	Name	Configuration
1	VD Cell	Drain voltage preamplifier stage
2	n. c.	
3	RF IN Cell	RF IN
4	n. c.	
5	Vneg	Negative voltage
6	Vcon	Control voltage
7	n. c.	
8	n. c.	
9	n. c.	
10	n. c.	
11	RF out	RF out / drain voltage final stage
12	RF out	RF out / drain voltage final stage
13	RF out	RF out / drain voltage final stage
14	RF out	RF out / drain voltage final stage
15	n. c.	
16	n. c.	

Electrical Characteristics

($T_A = 25^\circ\text{C}$, $Z_S=Z_L=50\ \Omega$, $V_D=3.5\text{V}$, $I_{DQ}=300\text{mA}$, unless otherwise specified)

Characteristics	Symbol	min	typ	max	Unit
Frequency range	f	824		849	MHz
Duty cycle	t_{ON}/t_{OFF}			100	%
AMPS output power	P		31,5		dBm
TDMA output power	P		30		dBm
AMPS gain at max. output	G		24		dB
TDMA gain at max. output	G		27		dB
CDMA output power	P		28		dBm
CDMA gain at max. output	G		28		dB
Power ramping characteristic Full output power Pinch off	V_{contr}		2.5 0.5		V
Adjacent Channel Power CDMA 900kHz offset 1.98 MHz offset	P_{adj}/P_{main}			-45 -54	dBc @ 30kHz
Adjacent channel power TDMA adjacent alternate 2nd alternate	P_{adj}/P_{main}			-28 -45 -45	dBc @ 30kHz
AMPS efficiency	PAE		55		%
TDMA DC to RF efficiency @ $P_{adj}=-26\text{dBc}$ at max. output	PAE		40		%
CDMA DC to RF efficiency @ $P_{adj}=-42\text{dBc}$ at max. output at $P_{out}=10\ \text{dBm}$ (I_Q set to 100mA)	PAE		35 8		%
Receive band noise power density (869 to 894 MHz)	P_{RX}			-137	dBm/Hz
Drain supply voltage range	V_D	2.7	3.5	4.0	V
Negative supply voltage range	V_{neg}	-5.0		-7	V
Standby current @ $V_{con}=0\text{V}$	$I_{pwr\ dwn}$		500		μA
Quiescent current	I_Q		300		mA
Current consumption at V_{Contr}	$I_{Control}$		2		mA
Current consumption at V_{NEG}	I_{NEG}		2		mA
Operating temperature range	ν	-30		+85	$^\circ\text{C}$

Power on sequence:

1. connect negative voltage to PA
2. connect control voltage to PA
3. turn on Vd
4. turn on Pin

To switch off the device please use reverse sequence.

Application Circuit:

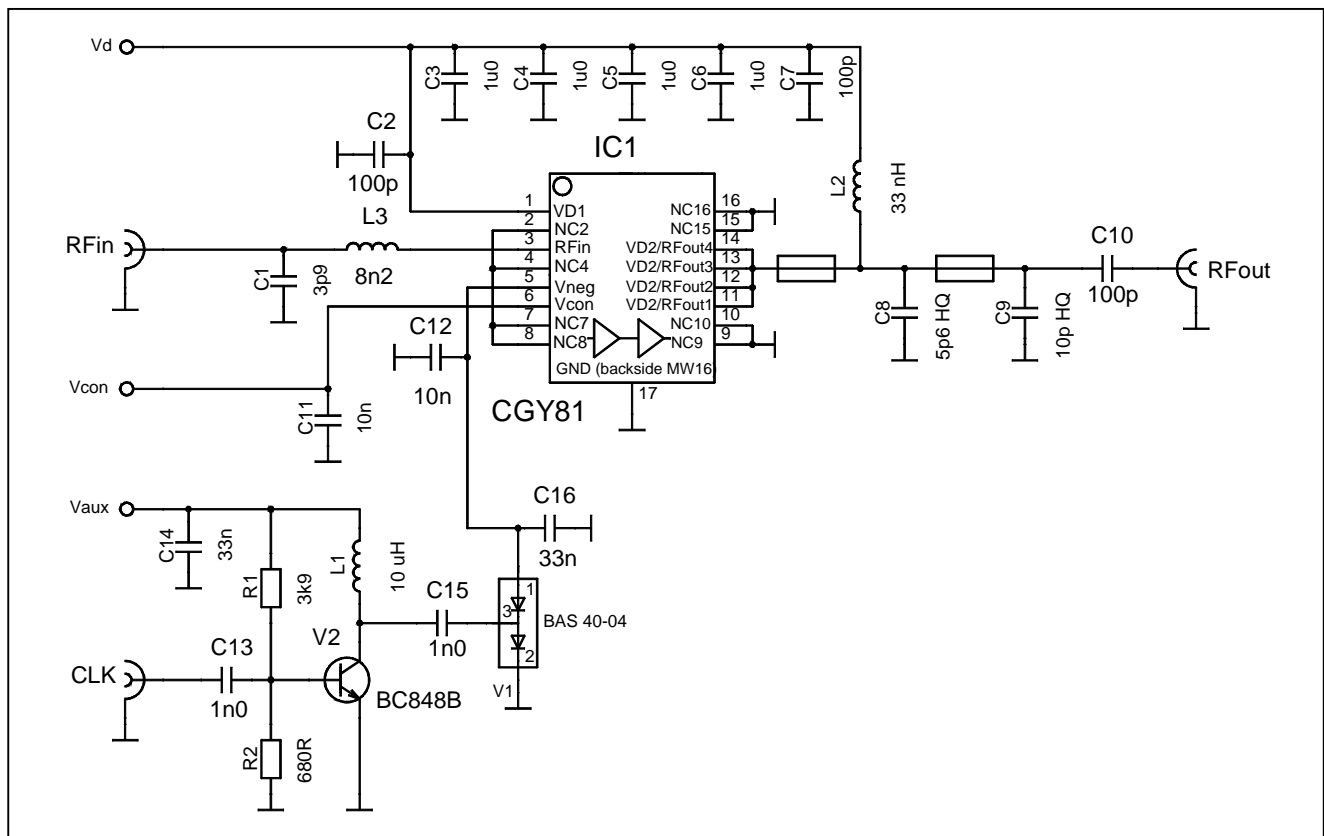

Evaluation Board Parts List

Part Type	Position	Description	Manufacturer	Part Number
Capacitor	C1	3.9pF 0402	Siemens	
Capacitor	C2, C7, C10	100pF 0402	Siemens	
Capacitor	C3, C4, C5, C6	1uF 1206	Siemens	
Capacitor	C8	5.6pF 0603 HQ	AVX	06035J5R6GBT
Capacitor	C9	10pF 0603 HQ	AVX	06035J100GBT
Capacitor	C11, C12	10 nF 0402	Siemens	
Capacitor	C13, C15	1 nF 0402	Siemens	

Part Type	Position	Description	Manufacturer	Part Number
Capacitor	C14, C16	33nF 0402	Siemens	
Inductor	L1	10uH	Siemens	
Inductor	L2	33nH Air Coil	H. David GmbH	PN/BV 1250
Inductor	L3	8.2nH 0603		
Resistor	R1	3.9k 0402		
Resistor	R2	680 Ohm 0402		
Diode	V1	BAS40-04W	Siemens	
Transistor	V2	BC848B	Siemens	
Substrate		FR4, h=0.2mm, $\epsilon_r=4.5$	Siemens	

Evaluation Board:

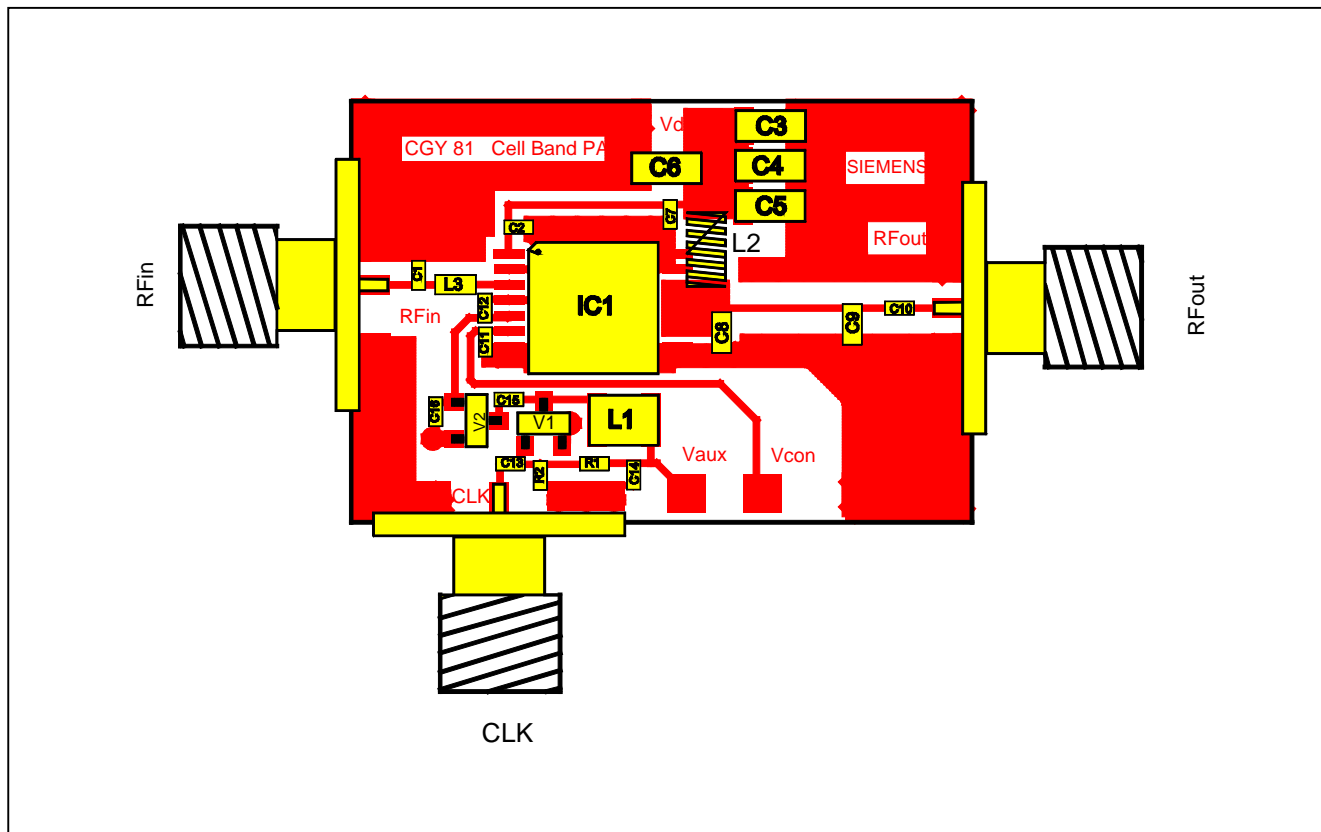

Typical Performance in AMPS Operation Mode

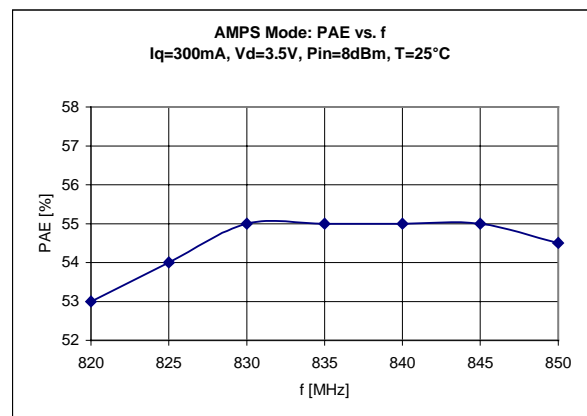
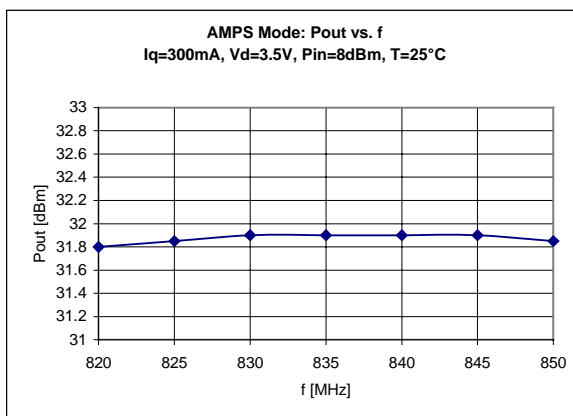
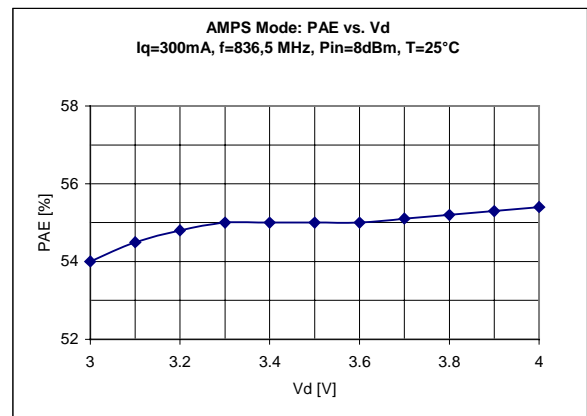
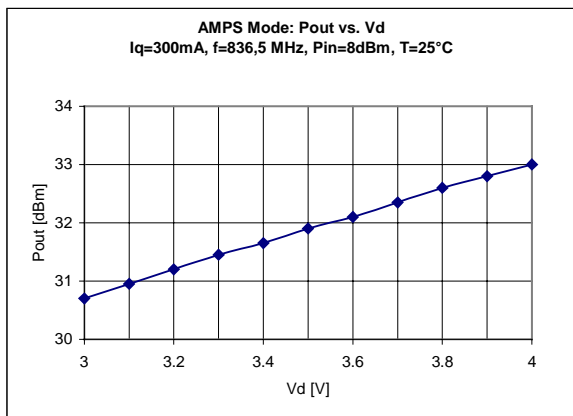
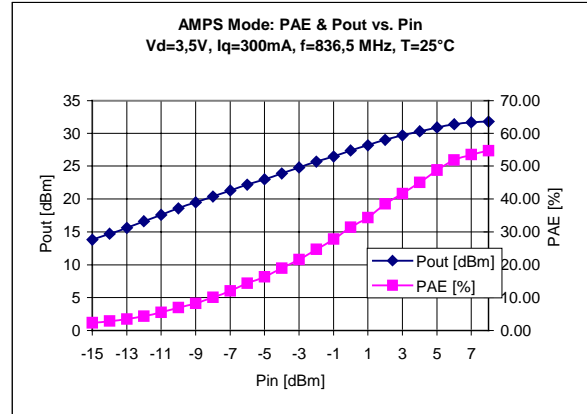
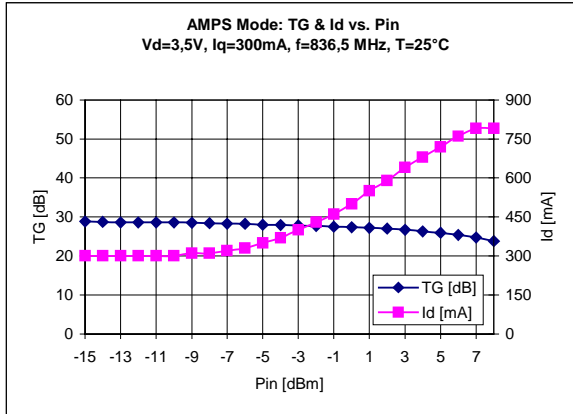

Typical Performance in CDMA Operation Mode:

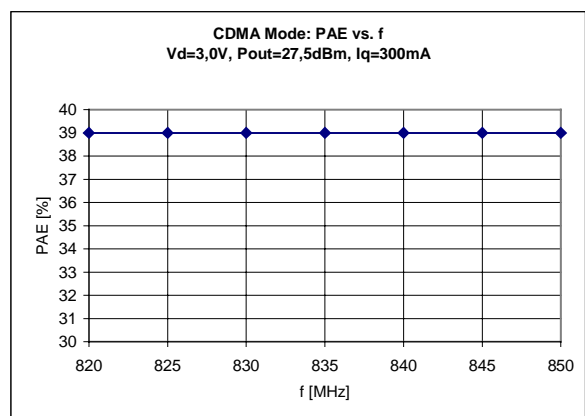
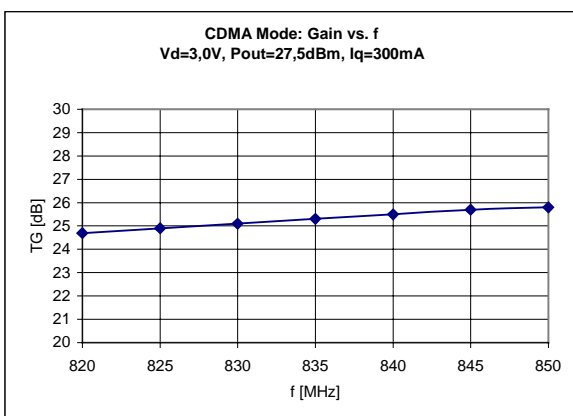
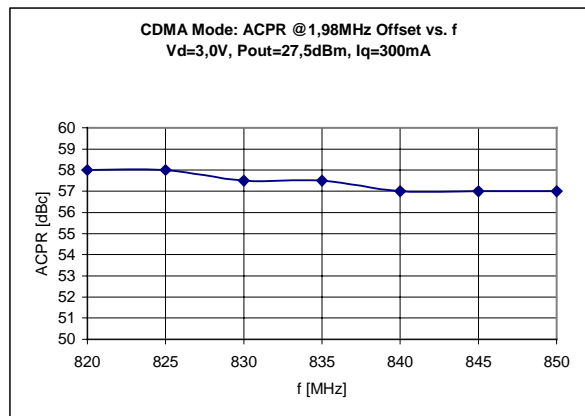
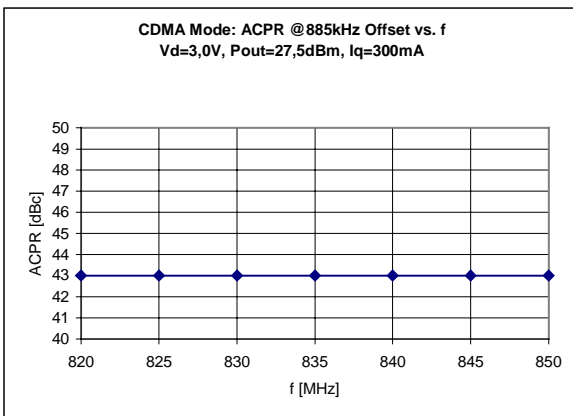
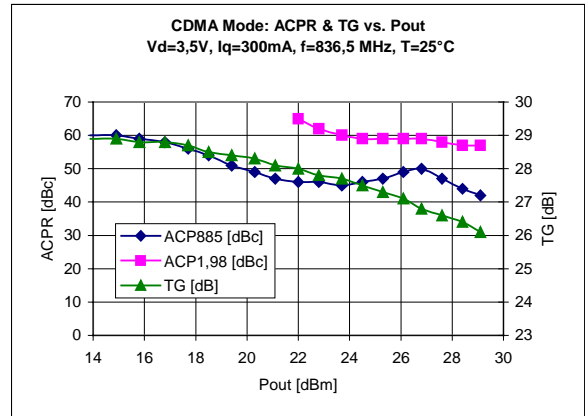
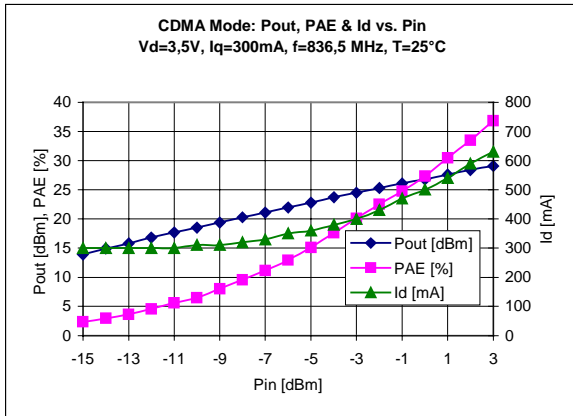

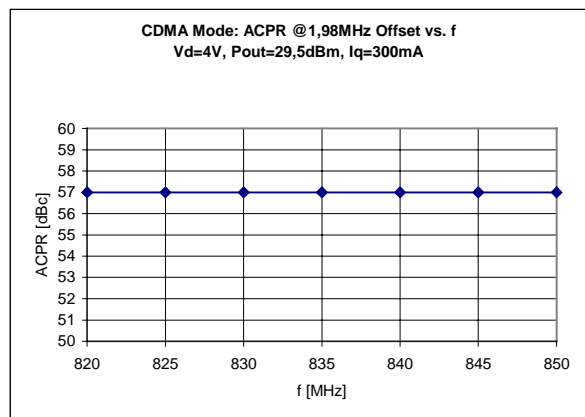
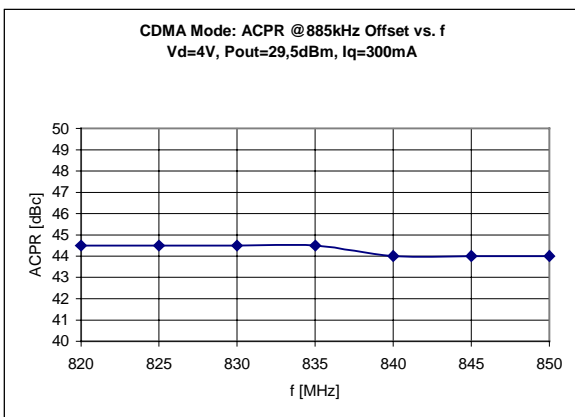
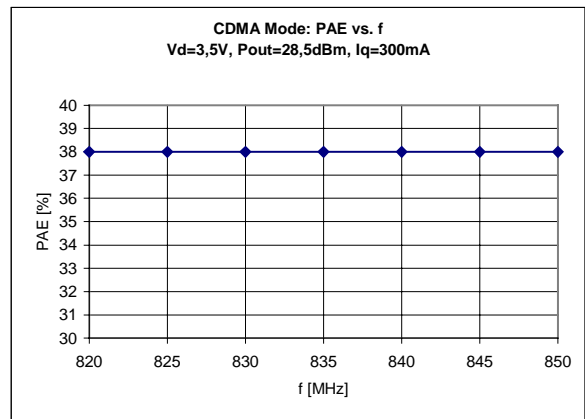
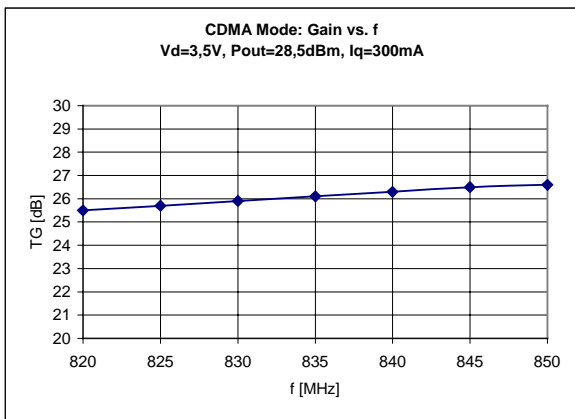
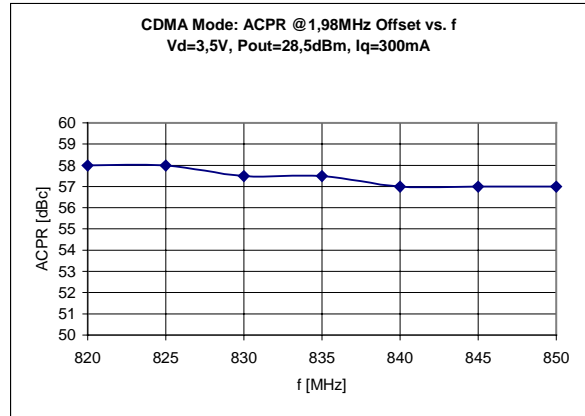
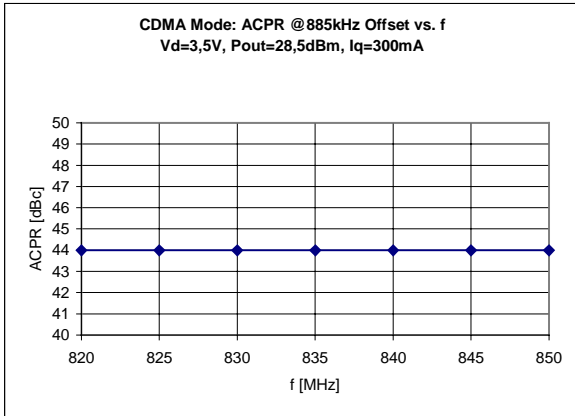

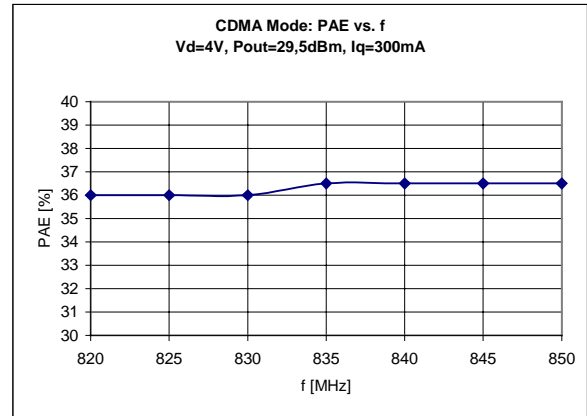
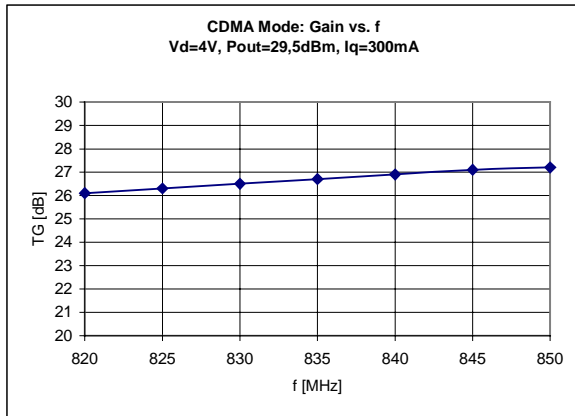

Typical Performance in TDMA Operation Mode

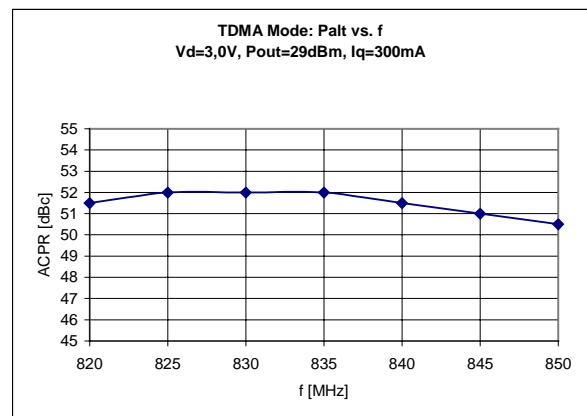
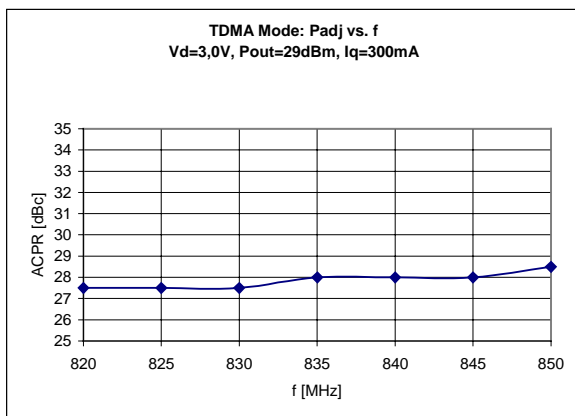
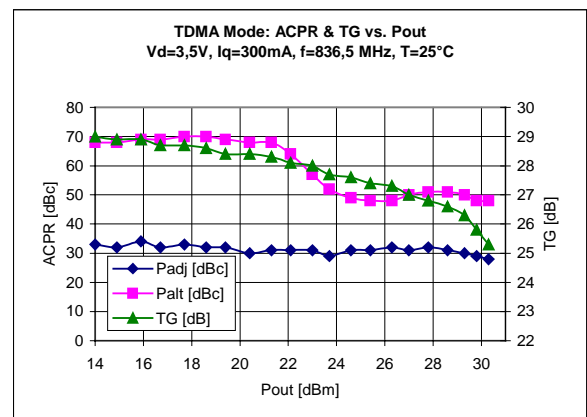
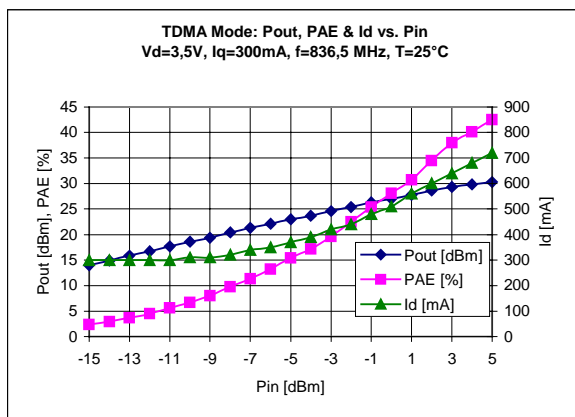

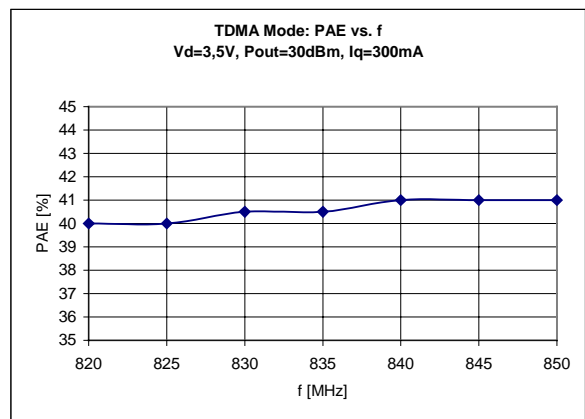
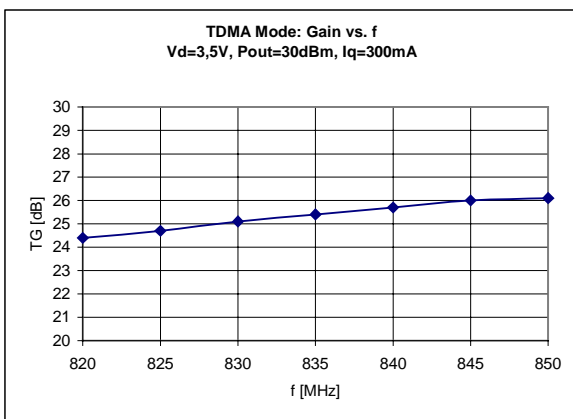
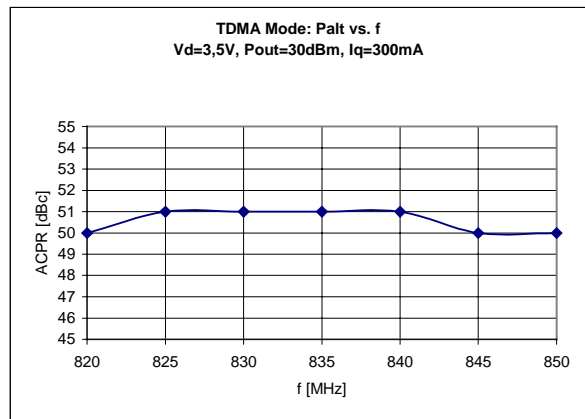
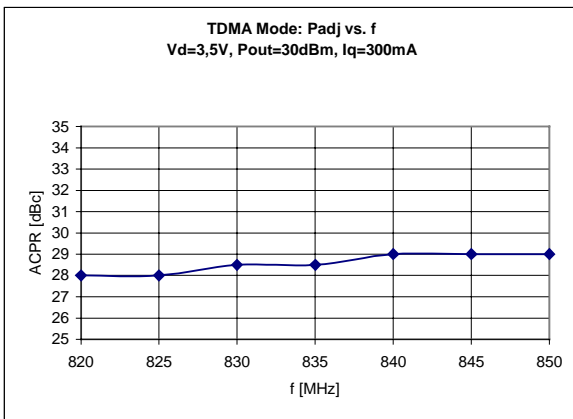
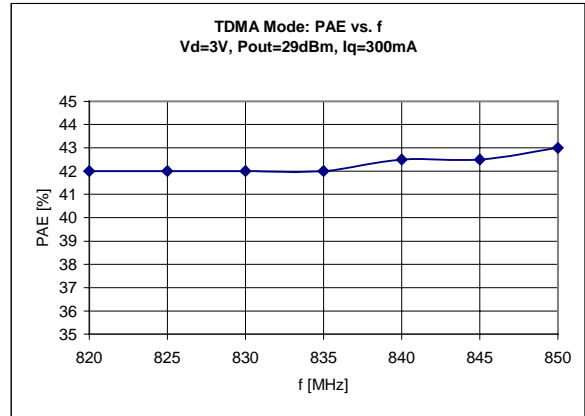
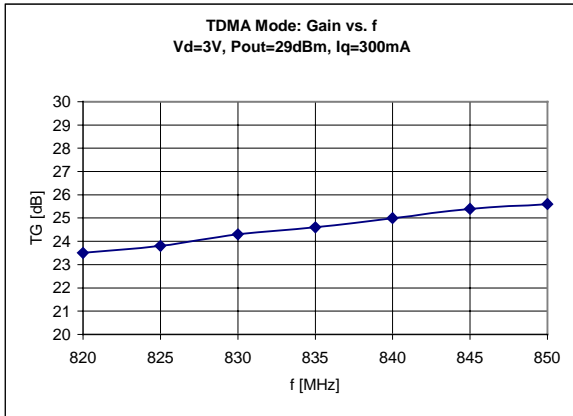

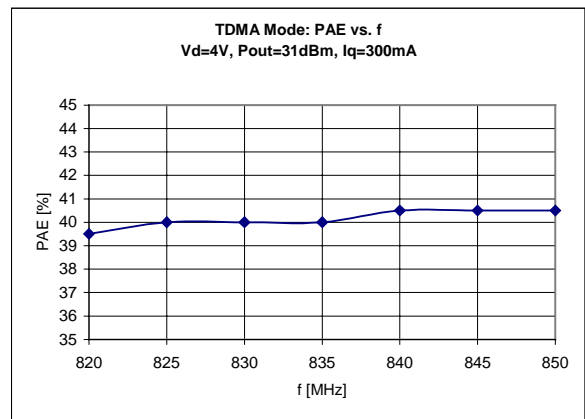
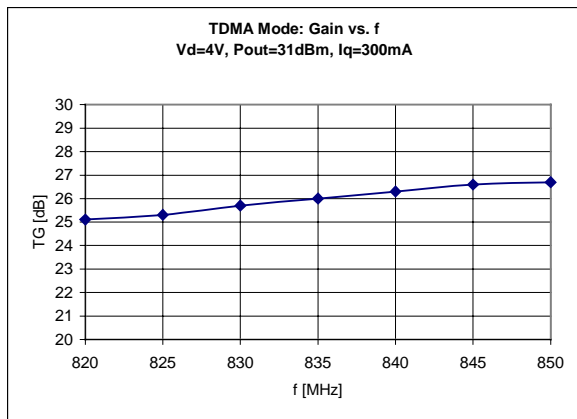
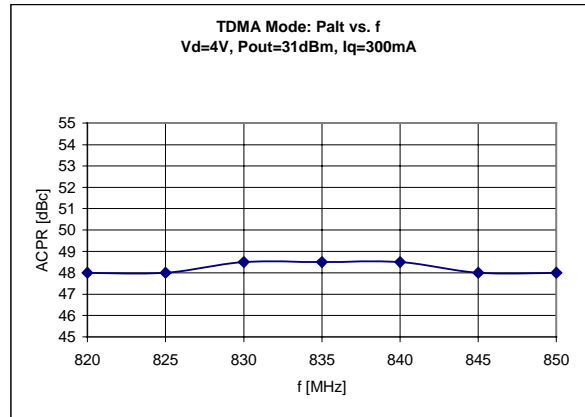
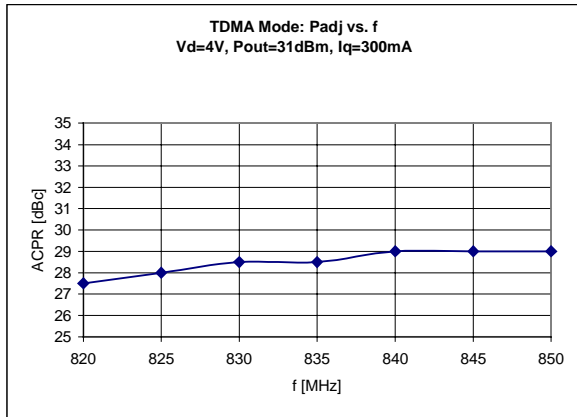

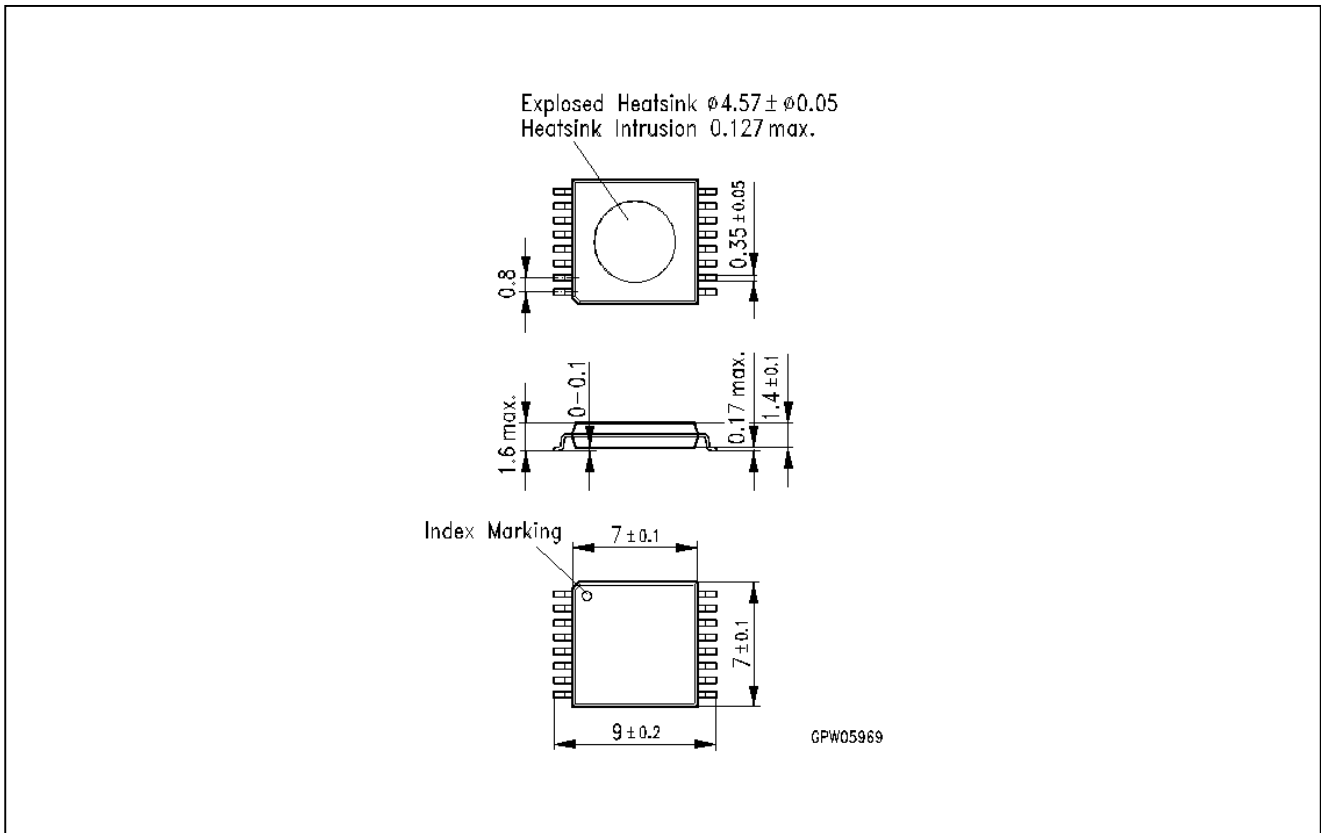

Published by Siemens AG, Bereich Bauelemente, Vertrieb, Produkt-Information, Balanstraße 73, D-81541 München

copyright Siemens AG 1996. All Rights Reserved

As far as patents or other rights of third parties are concerned, liability is only assumed for components per se, not for applications, processes and circuits implemented within components or assemblies.

The information describes the type of component and shall not be considered as assured characteristics.

Terms of delivery and rights to change design reserved.

For questions on technology, delivery and prices please contact the Offices of Semiconductor Group in Germany or the Siemens Companies and Representatives worldwide (see address list).

Due to technical requirements components may contain dangerous substances. For information on the type in question please contact your nearest Siemens Office, Semiconductor Group.

Siemens AG is an approved CECC manufacturer.