

## PNP Silicon AF Transistor

**BCP 69**

- For general AF application
- High collector current
- High current gain
- Low collector-emitter saturation voltage
- Complementary type: BCP 68 (NPN)

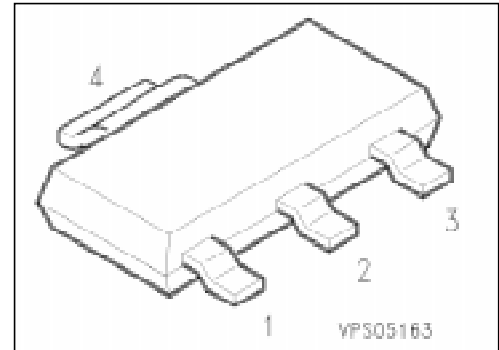

Type	Marking	Ordering Code (tape and reel)	Pin Configuration				Package <sup>1)</sup>
			1	2	3	4	
BCP 69	BCP 69	Q62702-C2130	B	C	E	C	SOT-223
BCP 69-10	BCP 69-10	Q62702-C2131					
BCP 69-16	BCP 69-16	Q62702-C2132					
BCP 69-25	BCP 69-25	Q62702-C2133					

### Maximum Ratings

Parameter	Symbol	Values	Unit
Collector-emitter voltage	$V_{CE0}$	20	V
	$V_{CES}$	25	
	Collector-base voltage	$V_{CB0}$	
Emitter-base voltage	$V_{EB0}$	5	
Collector current	$I_C$	1	A
Peak collector current	$I_{CM}$	2	
Base current	$I_B$	100	mA
Peak base current	$I_{BM}$	200	
Total power dissipation, $T_s = 124\text{ °C}^2)$	$P_{tot}$	1.5	W
Junction temperature	$T_j$	150	°C
Storage temperature range	$T_{stg}$	- 65 ... + 150	

### Thermal Resistance

Junction - ambient <sup>2)</sup>	$R_{th JA}$	≤ 72	K/W
Junction - soldering point	$R_{th JS}$	≤ 17	

<sup>1)</sup> For detailed information see chapter Package Outlines.

<sup>2)</sup> Package mounted on epoxy pcb 40 mm × 40 mm × 1.5 mm/6 cm<sup>2</sup> Cu.

**Electrical Characteristics**

at  $T_A = 25\text{ }^\circ\text{C}$ , unless otherwise specified.

Parameter	Symbol	Values			Unit
		min.	typ.	max.	

**DC characteristics**

Collector-emitter breakdown voltage $I_C = 30\text{ mA}, I_B = 0$	$V_{(BR)CE0}$	20	–	–	V
Collector-emitter breakdown voltage $I_C = 10\text{ }\mu\text{A}, V_{BE} = 0$	$V_{(BR)CES}$	25	–	–	
Collector-base breakdown voltage $I_C = 10\text{ }\mu\text{A}, I_B = 0$	$V_{(BR)CB0}$	25	–	–	
Emitter-base breakdown voltage $I_E = 10\text{ }\mu\text{A}, I_B = 0$	$V_{(BR)EB0}$	5	–	–	
Collector-base cutoff current $V_{CB} = 25\text{ V}$ $V_{CB} = 25\text{ V}, T_A = 150\text{ }^\circ\text{C}$	$I_{CB0}$	– –	– –	100 100	nA $\mu\text{A}$
Emitter-base cutoff current $V_{EB} = 5\text{ V}, I_C = 0$	$I_{EB0}$	–	–	100	nA
DC current gain <sup>1)</sup> $I_C = 5\text{ mA}, V_{CE} = 10\text{ V}$ $I_C = 500\text{ mA}, V_{CE} = 1\text{ V}$  $I_C = 1\text{ A}, V_{CE} = 1\text{ V}$	$h_{FE}$	50 85 85 100 160 60	– – 100 160 250 –	– 375 160 250 375 –	–
Collector-emitter saturation voltage <sup>1)</sup> $I_C = 1\text{ A}, I_B = 100\text{ mA}$	$V_{CEsat}$	–	–	0.5	V
Base-emitter voltage <sup>1)</sup> $I_C = 5\text{ mA}, V_{CE} = 10\text{ V}$ $I_C = 1\text{ A}, V_{CE} = 1\text{ V}$	$V_{BE}$	– –	0.6 –	– 1	

**AC characteristics**

Transition frequency $I_C = 100\text{ mA}, V_{CE} = 5\text{ V}, f = 100\text{ MHz}$	$f_T$	–	100	–	MHz
--	-------	---	-----	---	-----

<sup>1)</sup> Pulse test conditions:  $t \leq 300\text{ }\mu\text{s}, D = 2\text{ }%$ .

**Total power dissipation  $P_{tot} = f(T_A^*; T_S)$**

\* Package mounted on epoxy

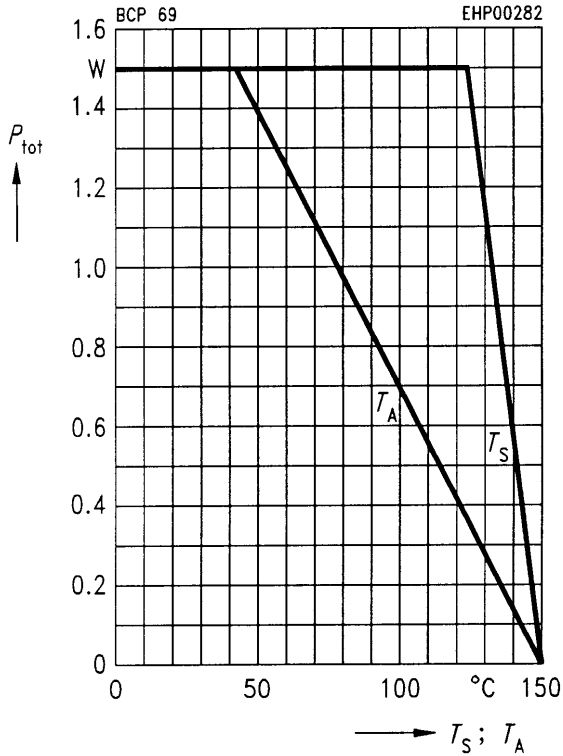

**Transition frequency  $f_T = f(I_C)$**

$V_{CE} = 5 V, f = 100 \text{ MHz}$

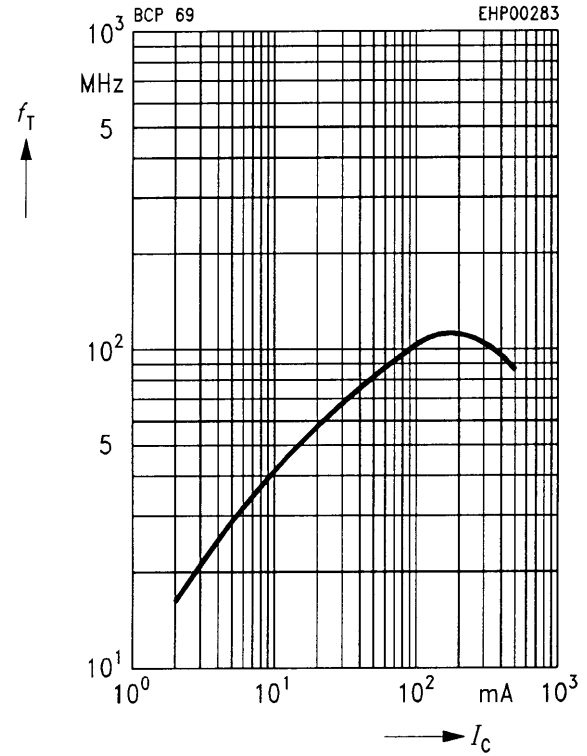

**Collector cutoff current  $I_{CB0} = f(T_A)$**

$V_{CB} = 25 V$

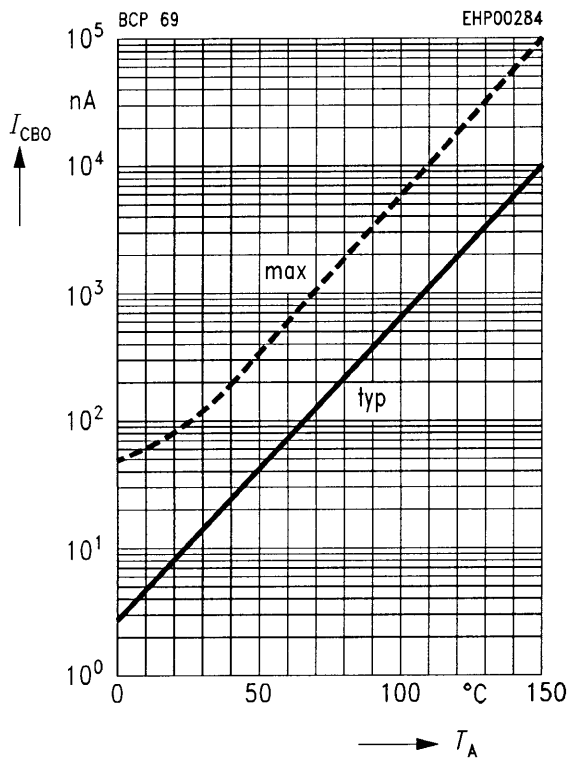

**DC current gain  $h_{FE} = f(I_C)$**

$V_{CB} = 1 V$

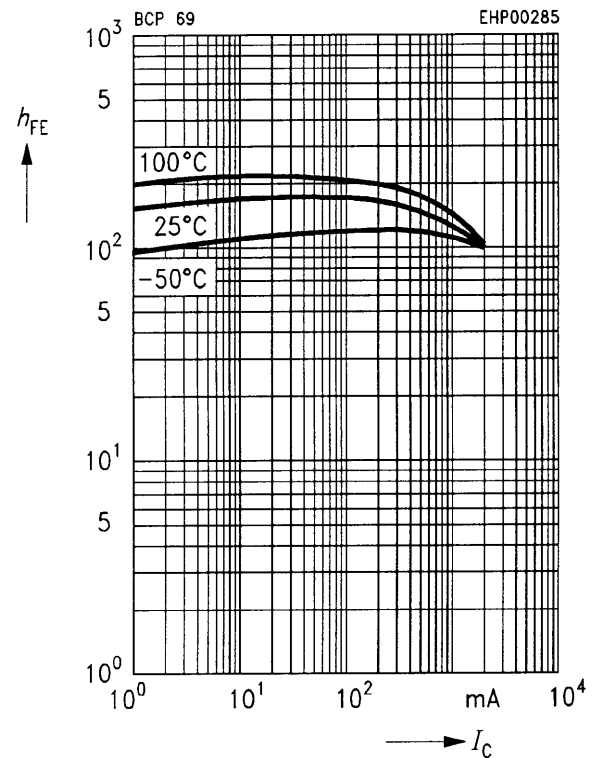

**Collector-emitter saturation voltage**

$I_C = f(V_{CEsat})$

$h_{FE} = 10$

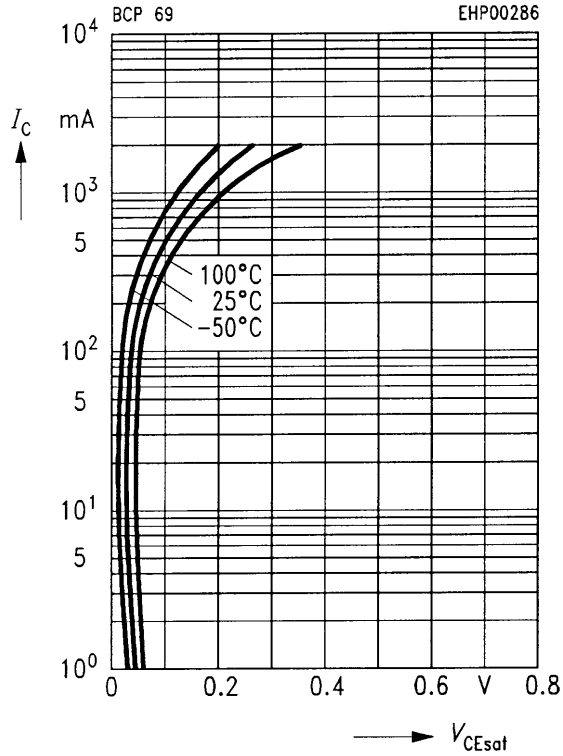

**Base-emitter saturation voltage**

$I_C = f(V_{BEsat})$

$h_{FE} = 10$

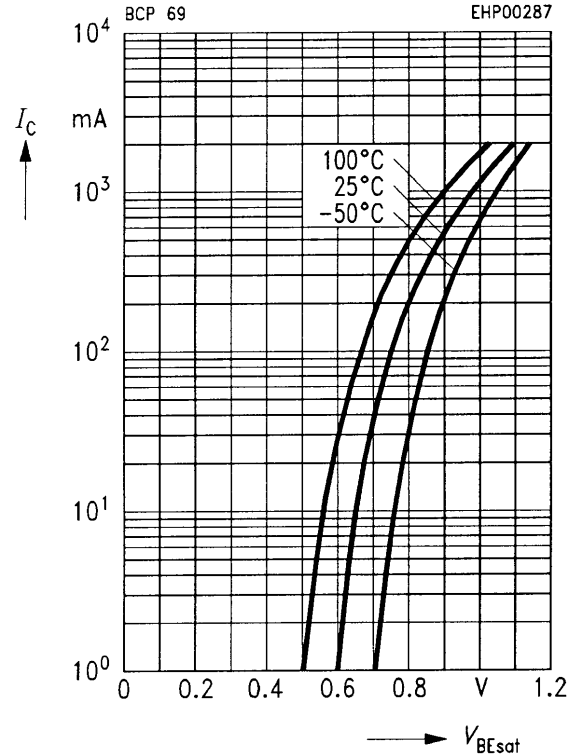

**Permissible pulse load  $P_{tot max}/P_{tot DC} = f(t_p)$**

