

## PNP Silicon Digital Transistor

- Switching circuit, inverter, interface circuit, driver circuit
- Built in bias resistor ( $R_1=4.7k\Omega$ ,  $R_2=47k\Omega$ )

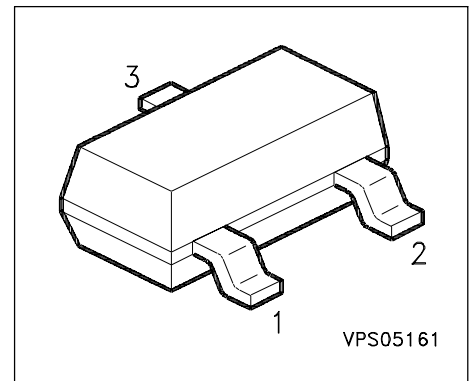
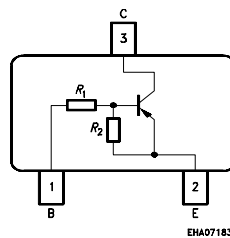

Type	Marking	Ordering Code	Pin Configuration			Package
			1=B	2=E	3=C	
BCR 166	WTs	Q62702-C2339	1=B	2=E	3=C	SOT-23

### Maximum Ratings

Parameter	Symbol	Values	Unit
Collector-emitter voltage	$V_{CEO}$	50	V
Collector-base voltage	$V_{CBO}$	50	
Emitter-base voltage	$V_{EBO}$	5	
Input on Voltage	$V_{i(on)}$	15	
DC collector current	$I_C$	100	mA
Total power dissipation, $T_S = 102^\circ\text{C}$	$P_{tot}$	200	mW
Junction temperature	$T_j$	150	$^\circ\text{C}$
Storage temperature	$T_{stg}$	- 65 ... + 150	

### Thermal Resistance

Junction ambient <sup>1)</sup>	$R_{thJA}$	$\leq 350$	K/W
Junction - soldering point	$R_{thJS}$	$\leq 240$	

1) Package mounted on pcb 40mm x 40mm x 1.5mm / 6cm<sup>2</sup> Cu

## Electrical Characteristics at $T_A=25^\circ\text{C}$ , unless otherwise specified

Parameter	Symbol	Values			Unit
		min.	typ.	max.	

### DC Characteristics

Collector-emitter breakdown voltage $I_C = 100 \mu\text{A}, I_B = 0$	$V_{(BR)CEO}$	50	-	-	V
Collector-base breakdown voltage $I_C = 10 \mu\text{A}, I_B = 0$	$V_{(BR)CBO}$	50	-	-	
Collector cutoff current $V_{CB} = 40 \text{V}, I_E = 0$	$I_{CBO}$	-	-	100	nA
Emitter cutoff current $V_{EB} = 5 \text{V}, I_C = 0$	$I_{EBO}$	-	-	155	$\mu\text{A}$
DC current gain $I_C = 5 \text{mA}, V_{CE} = 5 \text{V}$	$h_{FE}$	70	-	-	-
Collector-emitter saturation voltage 1) $I_C = 10 \text{mA}, I_B = 0.5 \text{mA}$	$V_{CEsat}$	-	-	0.3	V
Input off voltage $I_C = 100 \mu\text{A}, V_{CE} = 5 \text{V}$	$V_{i(off)}$	0.4	-	0.8	
Input on Voltage $I_C = 2 \text{mA}, V_{CE} = 0.3 \text{V}$	$V_{i(on)}$	0.5	-	1.4	
Input resistor	$R_1$	3.2	4.7	6.2	$\text{k}\Omega$
Resistor ratio	$R_1/R_2$	0.09	0.1	0.11	-

### AC Characteristics

Transition frequency $I_C = 10 \text{mA}, V_{CE} = 5 \text{V}, f = 100 \text{MHz}$	$f_T$	-	160	-	MHz
Collector-base capacitance $V_{CB} = 10 \text{V}, f = 1 \text{MHz}$	$C_{cb}$	-	3	-	pF

1) Pulse test:  $t < 300\mu\text{s}; D < 2\%$

### DC Current Gain $h_{FE} = f(I_C)$

$V_{CE} = 5V$  (common emitter configuration)

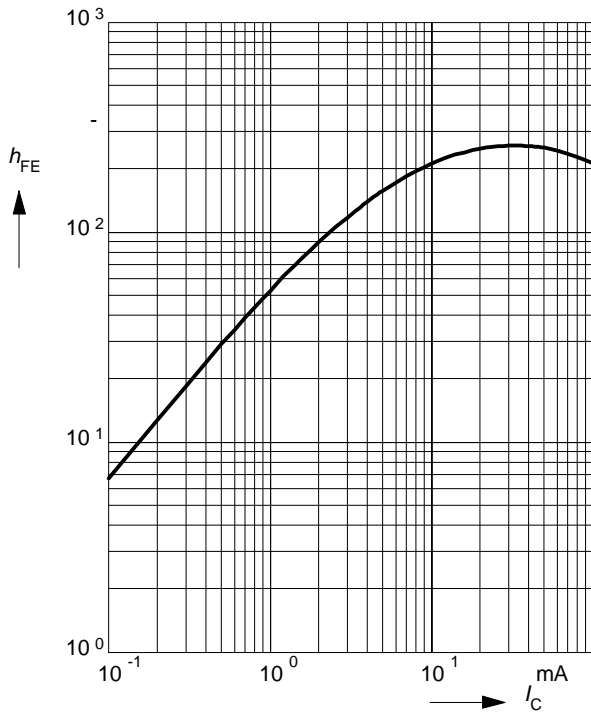

### Collector-Emitter Saturation Voltage $V_{CEsat} = f(I_C), h_{FE} = 20$

$V_{CEsat} = f(I_C), h_{FE} = 20$

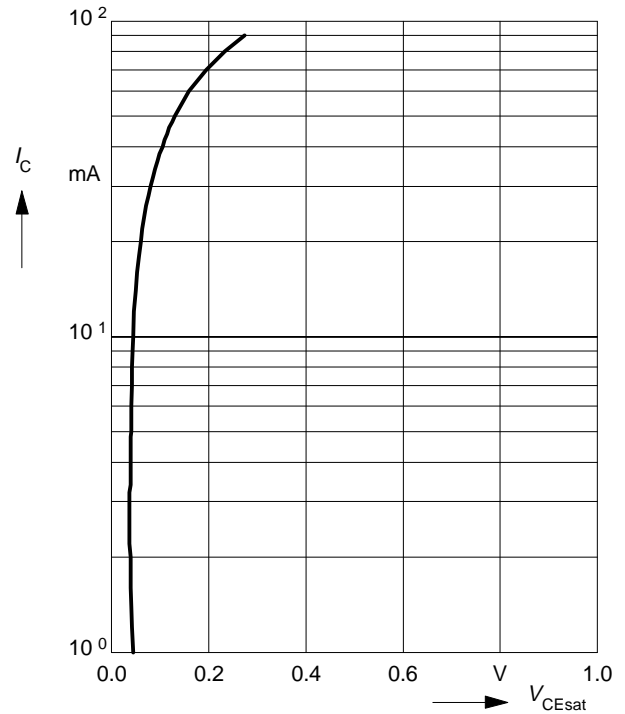

### Input on Voltage $V_{i(on)} = f(I_C)$

$V_{CE} = 0.3V$  (common emitter configuration)

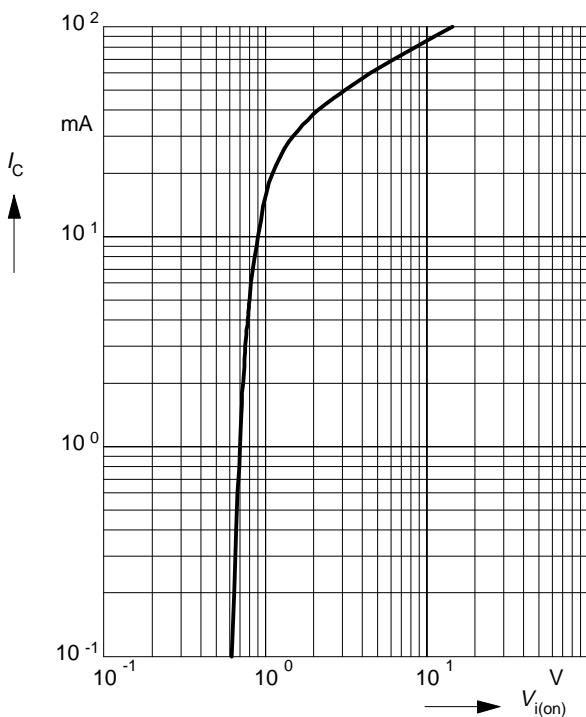

### Input off voltage $V_{i(off)} = f(I_C)$

$V_{CE} = 5V$  (common emitter configuration)

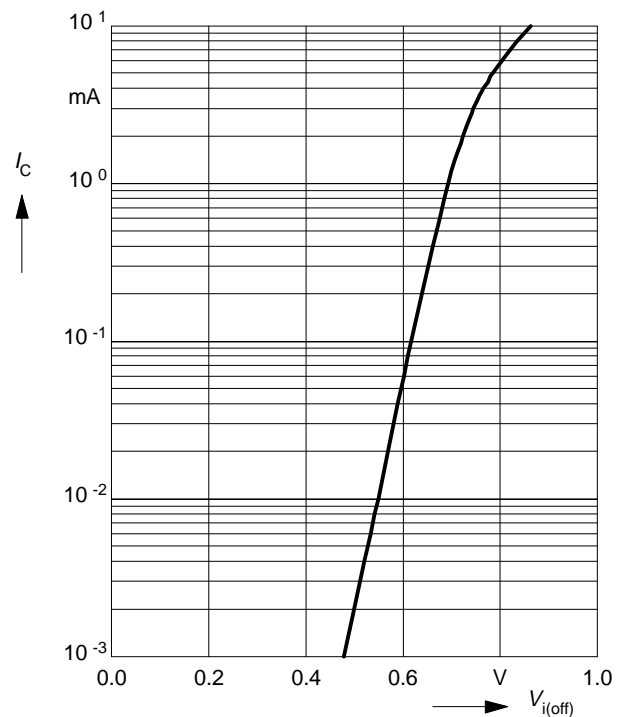

**Total power dissipation  $P_{tot} = f(T_A^*; T_S)$**

\* Package mounted on epoxy

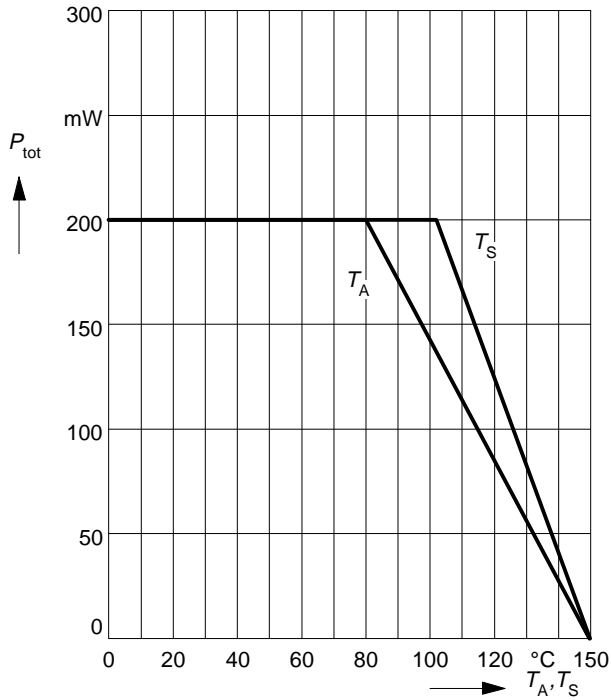

**Permissible Pulse Load  $R_{thJS} = f(t_p)$**

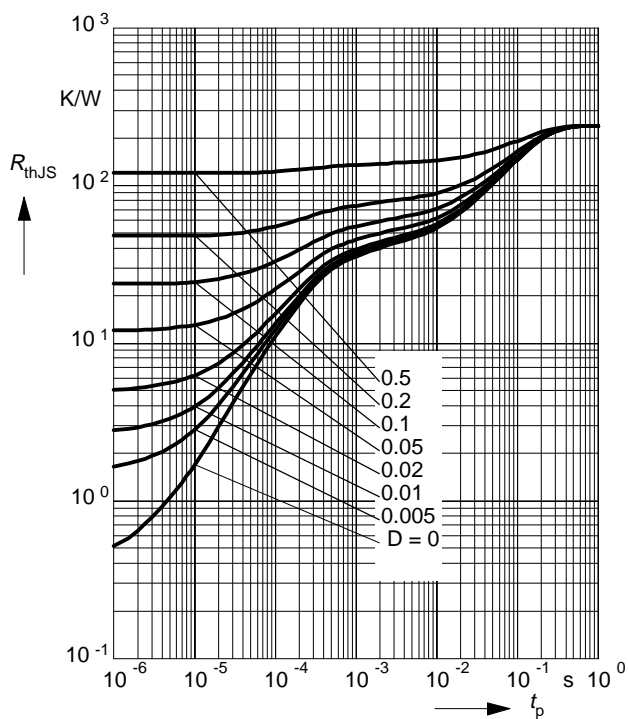

**Permissible Pulse Load  $P_{totmax} / P_{totDC} = f(t_p)$**

