

TRANSISTOR MODULE

QCA50AA100



UL;E76102 (M)

QCA50AA100 is a dual Darlington power transistor module which has series-connected high speed, high power Darlington transistors. Each transistor has a reverse paralleled fast recovery diode. The mounting base of the module is electrically isolated from semiconductor elements for simple heatsink construction,

- $I_C=50A$, $V_{CEX}=1000V$
- Low saturation voltage for higher efficiency.
- High DC current gain h_{FE}
- Isolated mounting base

(Applications)

Motor Control (VVVF), AC/DC Servo, UPS,
Switching Power Supply, Ultrasonic Application

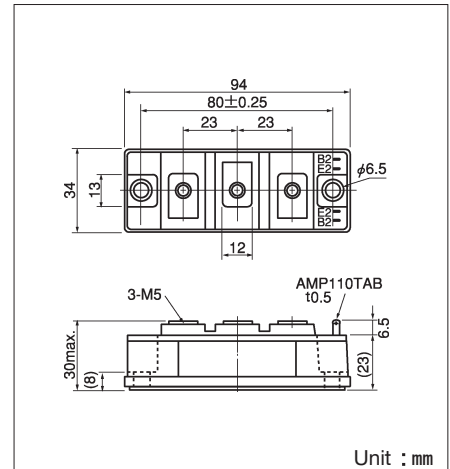
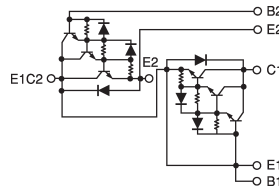

Maximum Ratings

($T_j=25^\circ C$)

| Symbol | Item | Conditions | Ratings | | |
|-----------|---------------------------|------------------|-----------------------------------|------------|-----------------|
| | | | QCA50AA100 | Unit | |
| V_{CBO} | Collector-Base Voltage | | 1000 | V | |
| V_{CEX} | Collector-Emitter Voltage | $V_{BE} = -2V$ | 1000 | V | |
| V_{EBO} | Emitter-Base Voltage | | 7 | V | |
| I_C | Collector Current | | 50 | A | |
| $-I_C$ | Reverse Collector Current | | 50 | A | |
| I_B | Base Current | | 3 | A | |
| P_T | Total power dissipation | $T_C=25^\circ C$ | 400 | W | |
| T_j | Junction Temperature | | -40~+150 | $^\circ C$ | |
| T_{stg} | Storage Temperature | | -40~+125 | $^\circ C$ | |
| V_{ISO} | Isolation Voltage | A.C.1minute | 2500 | V | |
| | Mounting Torque | Mounting (M6) | Recommended Value 2.5~3.9 (25~40) | 4.7 (48) | N·m (kgf·cm) |
| | | Terminal (M5) | Recommended Value 1.5~2.5 (15~25) | 2.7 (28) | |
| | Mass | Typical Value | 210 | g | |

Electrical Characteristics

($T_j=25^\circ C$)

| Symbol | Item | Conditions | Ratings | | Unit |
|----------------|--------------------------------------|---------------------------|---|------|--------------|
| | | | Min. | Max. | |
| I_{CBO} | Collector Cut-off Current | $V_{CB}=1000V$ | | 1.0 | mA |
| I_{EBO} | Emitter Cut-off Current | $V_{EB}=7V$ | | 200 | mA |
| $V_{CEX(SUS)}$ | Collector Emitter Sustaining Voltage | $I_C=10A$, $I_B=-3A$ | 1000 | | V |
| h_{FE} | DC Current Gain | $I_C=50A$, $V_{CE}=2.8V$ | 75 | | |
| | | $I_C=50A$, $V_{CE}=5V$ | 100 | | |
| $V_{CE(sat)}$ | Collector-Emitter Saturation Voltage | $I_C=50A$, $I_B=1A$ | | 2.5 | V |
| $V_{BE(sat)}$ | Base-Emitter Saturation Voltage | $I_C=50A$, $I_B=1A$ | | 3.5 | V |
| t_{on} | Switching Time | On Time | | 2.5 | μs |
| t_s | | Storage Time | $V_{CC}=600V$, $I_C=50A$ $I_{B1}=1A$, $I_{B2}=-1A$ | 15.0 | |
| t_f | | Fall Time | | 3.0 | |
| V_{ECO} | Collector-Emitter Reverse Voltage | $-I_C=50A$ | | 1.8 | V |
| $R_{th(j-c)}$ | Thermal Impedance (junction to case) | Transistor part | | 0.31 | $^\circ C/W$ |
| | | Diode part | | 1.2 | |

D.C. Current Gain

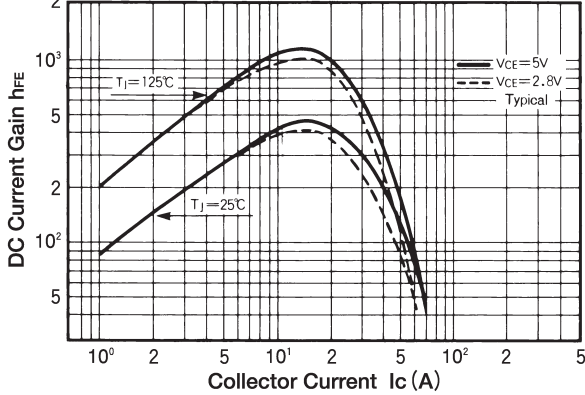

Saturation Characteristics

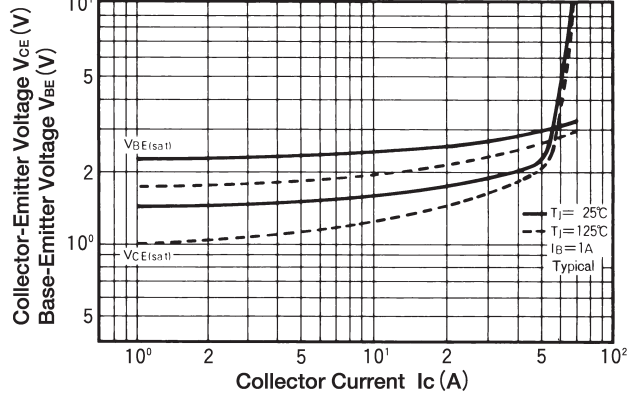

Forward Bias Safe Operating Area

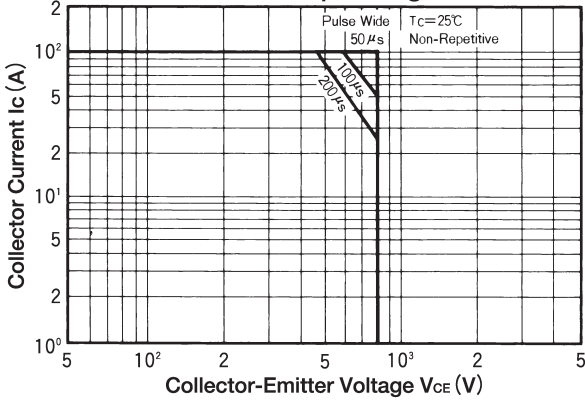

Reverse Bias Safe Operating Area

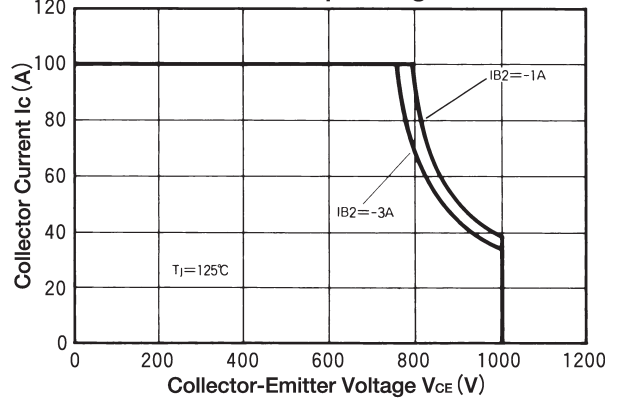

Collector Current Derating Factor

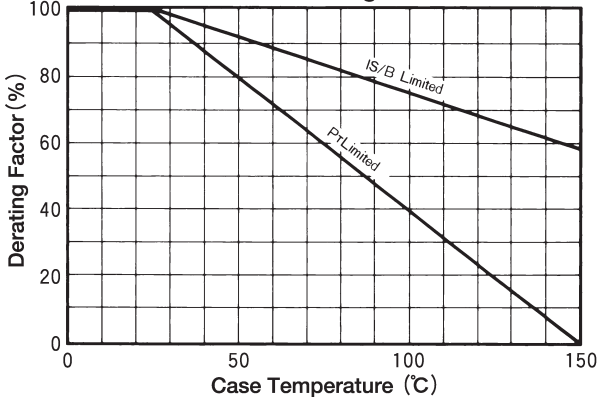

Forward Voltage of Free Wheeling Diode

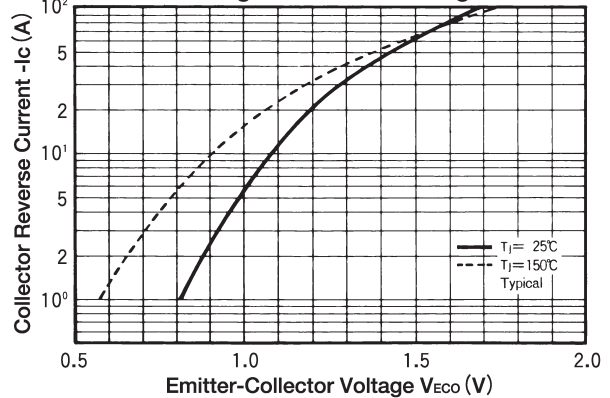

Collector Current Vs Switching Time

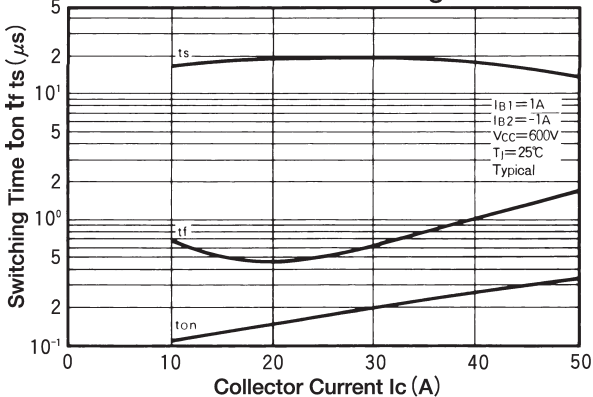

Maximum Transient Thermal Impedance Characteristics

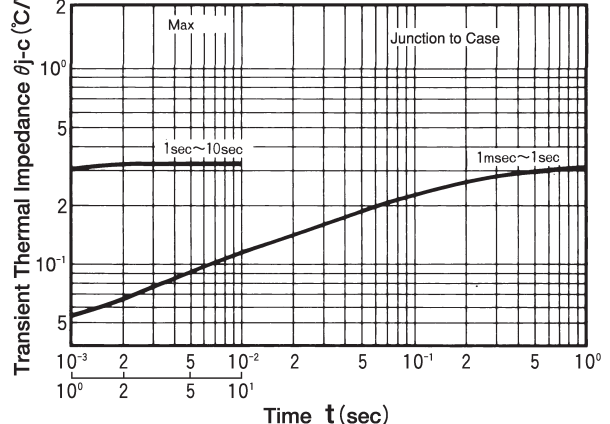

TRANSISTOR MODULE

QCA50AA120



UL;E76102 (M)

QCA50AA120 is a dual Darlington power transistor module which has series- connected high speed, high power Darlington transistors. Each transistor has a reverse paralleled fast recovery diode. The mounting base of the module is electrically isolated from semiconductor elements for simple heatsink construction,

- $I_C=50A$, $V_{CEX}=1200V$
- Low saturation voltage for higher efficiency.
- High DC current gain h_{FE}
- Isolated mounting base

(Applications)

Motor Control (VVVF), AC/DC Servo, UPS, Switching Power Supply, Ultrasonic Application

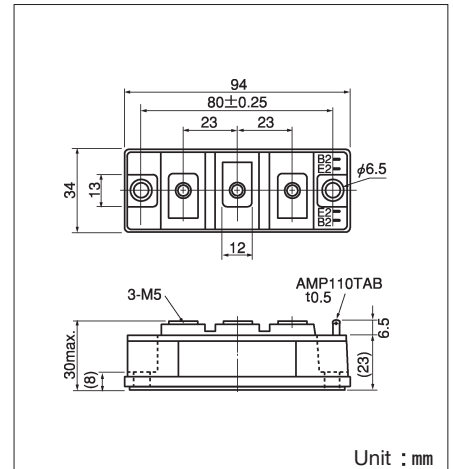
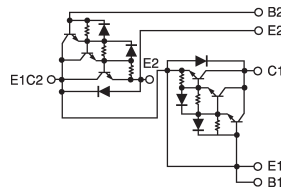

Unit : mm

Maximum Ratings

($T_j=25^\circ C$)

| Symbol | Item | Conditions | Ratings | | |
|-----------|---------------------------|------------------|-----------------------------------|------------|-----------------|
| | | | QCA50AA120 | Unit | |
| V_{CB0} | Collector-Base Voltage | | 1200 | V | |
| V_{CEX} | Collector-Emitter Voltage | $V_{BE} = -2V$ | 1200 | V | |
| V_{EB0} | Emitter-Base Voltage | | 10 | V | |
| I_C | Collector Current | | 50 | A | |
| $-I_C$ | Reverse Collector Current | | 50 | A | |
| I_B | Base Current | | 3 | A | |
| P_T | Total power dissipation | $T_C=25^\circ C$ | 400 | W | |
| T_j | Junction Temperature | | -40 ~ +150 | $^\circ C$ | |
| T_{stg} | Storage Temperature | | -40 ~ +125 | $^\circ C$ | |
| V_{ISO} | Isolation Voltage | A.C.1minute | 2500 | V | |
| | Mounting Torque | Mounting (M6) | Recommended Value 2.5~3.9 (25~40) | 4.7 (48) | N·m (kgf·cm) |
| | | Terminal (M5) | Recommended Value 1.5~2.5 (15~25) | 2.7 (28) | |
| | Mass | Typical Value | 210 | g | |

Electrical Characteristics

($T_j=25^\circ C$)

| Symbol | Item | Conditions | Ratings | | Unit |
|----------------|--------------------------------------|-------------------------|---|------|--------------|
| | | | Min. | Max. | |
| I_{CBO} | Collector Cut-off Current | $V_{CB}=1200V$ | | 1.0 | mA |
| I_{EBO} | Emitter Cut-off Current | $V_{EB}=10V$ | | 300 | mA |
| $V_{CEX(SUS)}$ | Collector Emitter Sustaning Voltage | $I_C=10A$, $I_B=-2A$ | 1200 | | V |
| h_{FE} | DC Current Gain | $I_C=50A$, $V_{CE}=5V$ | 75 | | |
| $V_{CE(sat)}$ | Collector-Emitter Saturation Voltage | $I_C=50A$, $I_B=1A$ | | 3.0 | V |
| $V_{BE(sat)}$ | Base-Emitter Saturation Voltage | $I_C=50A$, $I_B=1A$ | | 3.5 | V |
| t_{on} | Switching Time | On Time | | 2.5 | μs |
| t_s | | Storage Time | $V_{CC}=600V$, $I_C=50A$ $I_{B1}=1A$, $I_{B2}=-1A$ | 15.0 | |
| t_f | | Fall Time | | 3.0 | |
| V_{ECO} | Collector-Emitter Reverse Voltage | $-I_C=50A$ | | 1.8 | V |
| $R_{th(j-c)}$ | Thermal Impedance (junction to case) | Transistor part | | 0.31 | $^\circ C/W$ |
| | | Diode part | | 1.2 | |

D.C. Current Gain

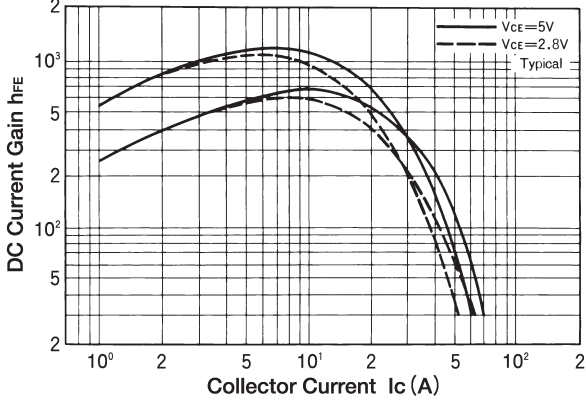

Saturation Characteristics

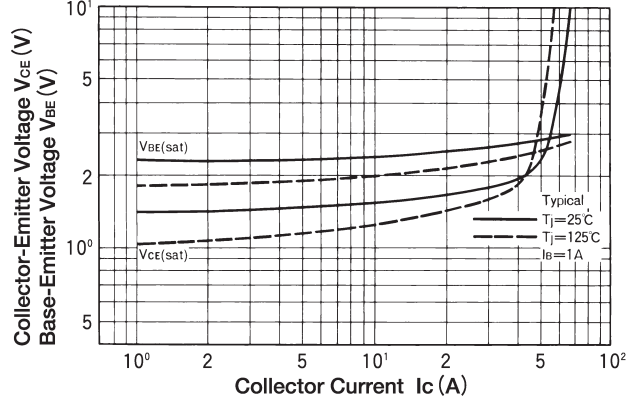

Forward Bias Safe Operating Area

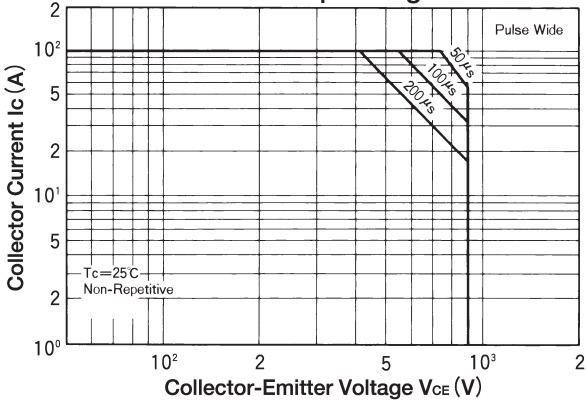

Reverse Bias Safe Operating Area

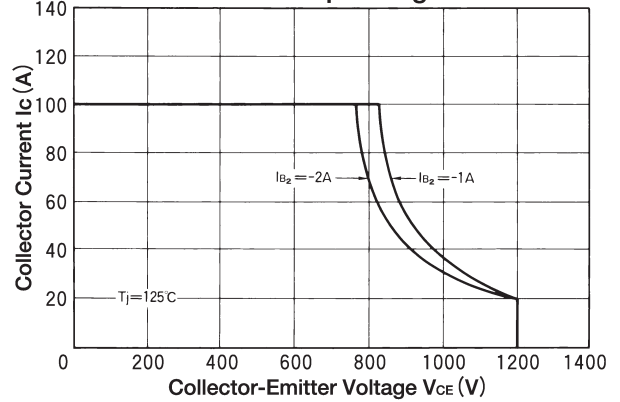

Collector Current Derating Factor

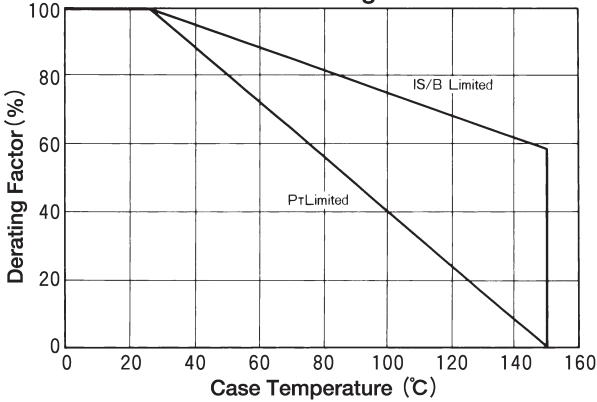

Forward Voltage of Free Wheeling Diode

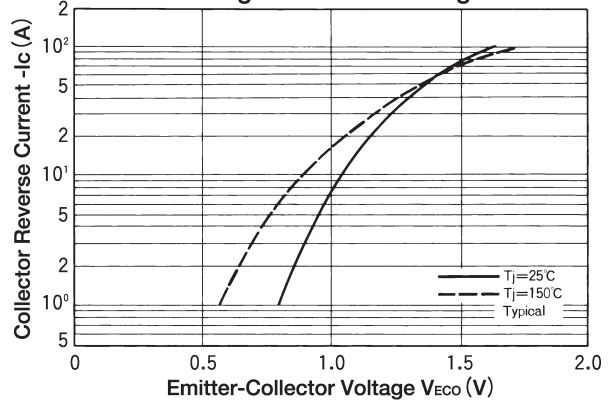

Collector Current Vs Switching Time

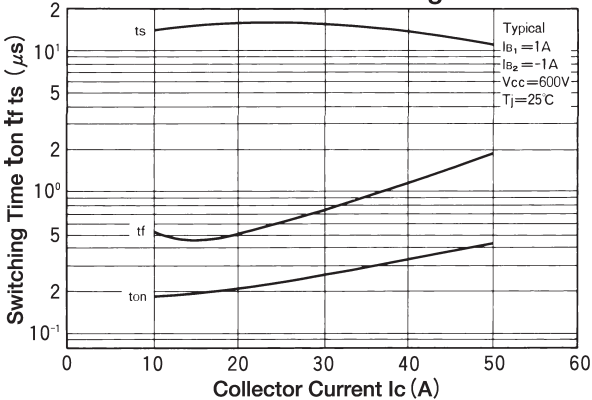

Maximum Transient Thermal Impedance Characteristics

