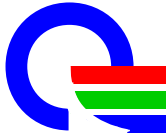

**Preliminary  
Spec.****Quanta Display Inc.  
SPECIFICATION****Doc No. QD14TL0103****Doc. REV.: 02****Issue Date: 4/08/2005****With RoHS  
Compliant****Specification for TFT LCD Module****Model No.****QD14TL01****Rev.:03****Approved By**

		<b>Quanta Display Inc.</b>

**These specification sheets are the proprietary product of Quanta Display Inc. ("QDI") and include materials protected under copyright of QDI. Do not reproduce or cause any third party to reproduce them in any form or by any means, electronic or mechanical, for any purpose, in whole or in part, without the express written permission of QDI.**

**The device listed in these technical literature sheets was designed and manufactured for use in OA equipment.**

**In case of using the device for applications such as control and safety equipment for transportation (aircraft, trains, automobiles, etc.), rescue and security equipment and various safety related equipment which require higher reliability and safety, take into consideration that appropriate measures such as fail-safe functions and redundant system design should be taken.**

**Do not use the device for equipment that requires an extreme level of reliability, such as aerospace applications, telecommunication equipment (trunk lines), nuclear power control equipment and medical or other equipment for life support.**

**QDI assumes no responsibility for any damage resulting from the use of the device, which does not comply with the instructions, and the precautions specified in these technical literature sheets.**

**Contact and consult with a QDI sales representative for any questions about this device.**



## 1. Application

This specification applies to a color TFT-LCD module, QD14TL0103.

## 2. Overview

This module is a color active matrix LCD module incorporating amorphous silicon TFT (Thin Film Transistor). It is composed of a color TFT-LCD panel, driver ICs, control circuit, power supply circuit and a backlight unit. Graphics and texts can be displayed on a 1280x3x800 dots panel with 262,144 colors by using LVDS (Low Voltage Differential Signaling) to interface and supplying +3.3V DC supply voltage for TFT-LCD panel driving and supply voltage for backlight.

The TFT-LCD panel used for this module has very high aperture ratio. A low-reflection and higher-color-saturation type color filter is also used for this panel. Therefore, high-brightness and high-contrast image, which is suitable for the multimedia use, can be obtained by using this module.

Optimum viewing direction is 6 o'clock.

### [Features]

- 1) High aperture ratio, high-brightness.
- 2) Brilliant and high contrast image.
- 3) Small footprint and thin shape.
- 4) WXGA resolution (800 vertical by 1280 horizontal pixel array).
- 5) LVDS interface.
- 6) Low power consumption.
- 7) RoHS compliant

## 3. General Specifications

Parameter	Specifications	Unit
Display size	14.1" Diagonal	in
Active area	303.7 (H)×189.8 (V)	mm
Pixel format	1280 (H)×800 (V)	Pixel
	(1 pixel = R+G+B dots)	
Pixel pitch	0.2373(H) × 0.2373 (V)	mm
Pixel configuration	R, G, B vertical stripe	
Display mode	Normally white	
Unit outline dimensions (typ.)*1	320.0 (H)×206 (V)×5.5 (T)	mm
Mass	440 max.	g
Surface treatment	Anti-Glare + Hardness 3H	

[Note] : excluding backlight cables. Outline dimensions are shown in this specification.

## 4. Input Connectors

### 4-1 Signal Interface Connector

CN1 (1 channel, LVDS signals – NSC/Ti standard and +3.3V DC power supply)

Using connector: FI-XB30Sx-HFxx/FI-X30Sx-HFxx/equivalent (JAE)

#### Interface Cable Pin Assignments

PIN NO	SYMBOL	FUNCTION
1	Vss	Ground
2	VDD	Power Supply, 3.3 V (typical)
3	VDD	Power Supply, 3.3 V (typical)
4	V EEDID	DDC 3.3V power
5	NC	Reserved for supplier test point
6	Clk EEDID	DDC Clock
7	DATA EEDID	DDC Data
8	Rin0-	- LVDS differential data input (R0-R5, G0) (odd pixels)
9	Rin0+	+ LVDS differential data input (R0-R5, G0) (odd pixels)
10	Vss	Ground
11	Rin1-	- LVDS differential data input (G1-G5, B0-B1) (odd pixels)
12	Rin1+	+ LVDS differential data input (G1-G5, B0-B1) (odd pixels)
13	Vss	Ground
14	Rin2-	- LVDS differential data input (B2-B5, HS, VS, DE) (odd pixels)
15	Rin2+	+ LVDS differential data input (B2-B5, HS, VS, DE) (odd pixels)
16	Vss	Ground
17	ClkIN-	- LVDS differential clock input (odd pixels)
18	ClkIN+	+ LVDS differential clock input (odd pixels)
19	Vss	Ground
20	NC	No connect
21	NC	No connect
22	Vss	Ground
23	NC	No connect
24	NC	No connect
25	Vss	Ground
26	NC	No connect
27	NC	No connect
28	Vss	Ground
29	NC	No connect
30	NC	No connect

[Note 1] Relation between LVDS signals and actual data shows below section (4-2).

[Note 2] The shielding case is connected with signal GND.

**4-2 Interface Block diagram**

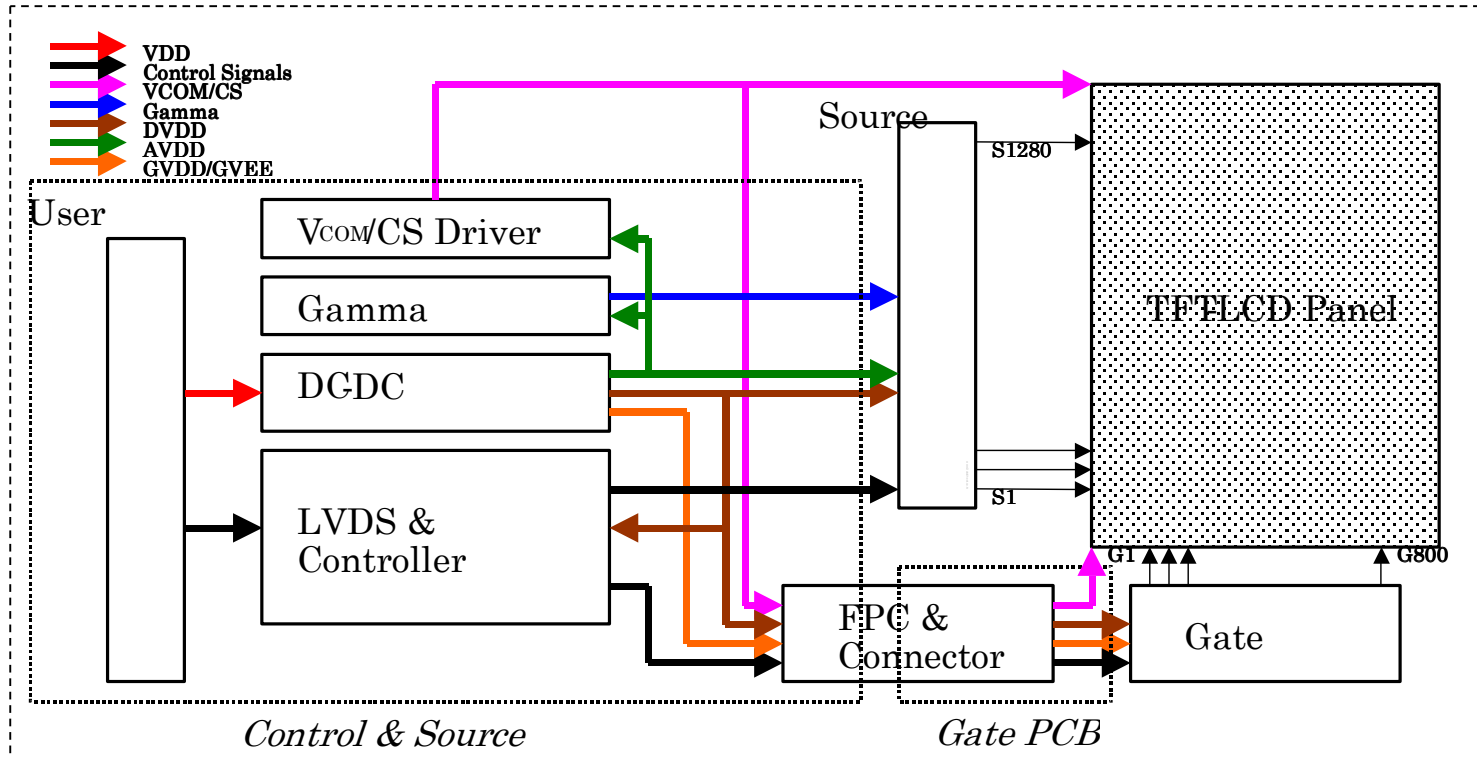

### 4-3. Backlight driving

CN2: BHSR-02VS-1 (JST)

Mating connector: SM02B-BHSS-1-TB (JST) or 87210-0200

Pin No.	Symbol	Function
1	V <sub>HIGH</sub>	Power supply for lamp (High voltage side)
2	V <sub>LOW</sub>	Power supply for lamp (Low voltage side)

[Note] VBLH and VBLC must be connected correctly. If user connects wrongly, the user will be hurt and module will be broken.

## 5. Absolute Maximum Ratings

### 5-1 LCD module

Parameter	Symbol	Condition	Ratings	Unit	Remark
Input voltage	V <sub>I</sub>	Ta=25°C	-0.3 ~ VDD+0.3	V	[Note1]
+3.3V supply voltage	VDD	Ta=25°C	0 ~ + 4	V	
Storage temperature	Tstg	—	-25 ~+60	°C	[Note2]
Operating temperature (Ambient)	Topa	—	0~+50	°C	[Note3]

[Note1] LVDS signals

[Note2] Humidity : 95%RH Max. at Ta≤40°C.

Maximum wet-bulb temperature at 39°C or less at Ta>40°C.

No condensation.

[Note3] When you apply the LCD module for OA system. Please make sure to keep the temperature of LCD module is less than 60 °C

**6. Electrical Characteristics**
**6-1.TFT-LCD panel driving**

Ta=25°C

Parameter		Symbol	Min.	Typ.	Max.	Unit	Remark
VDD	Supply voltage	VDD	+3.0	+3.3	+3.6	V	[Note2]
	Current dissipation	IDD	220	310	450	mA	[Note3]
Permissive input ripple voltage		V <sub>RP</sub>	—	—	100	mV p-p	V <sub>cc</sub> =+3.3V
Differential input Threshold voltage	High	V <sub>TH</sub>	—	—	100	mV	V <sub>CM</sub> =+1.2V [Note1]
	Low	V <sub>TL</sub>	-100	—	—	mV	
Terminal resistor		R <sub>T</sub>	—	100	—	Ω	Differential input
Rush current		I <sub>RUSH</sub>			1.5	A	Rise time 470uS

 [Note 1] V<sub>CM</sub> : Common mode voltage of LVDS driver.

[Note 2] On-off conditions for supply voltage

$0.5 < t_1 \leq 10 \text{ ms}$

$0 < t_2 \leq 50 \text{ ms}$

$0 < t_3 \leq 50 \text{ ms}$

$400 \text{ ms} \leq t_4$

$200 \text{ ms} \leq t_5$

$200 \text{ ms} \leq t_6$

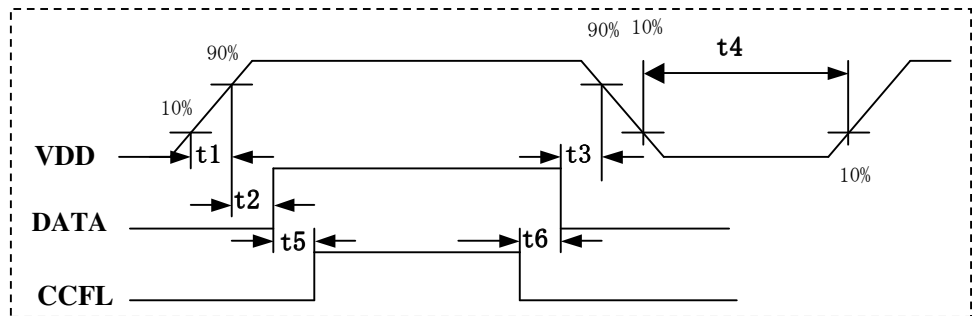
**V<sub>cc</sub>-dip conditions**

1)  $2.5 \text{ V} \leq V_{cc} < 3.0 \text{ V}$   
 $t_d \leq 10 \text{ ms}$

2)  $V_{cc} < 2.5 \text{ V}$

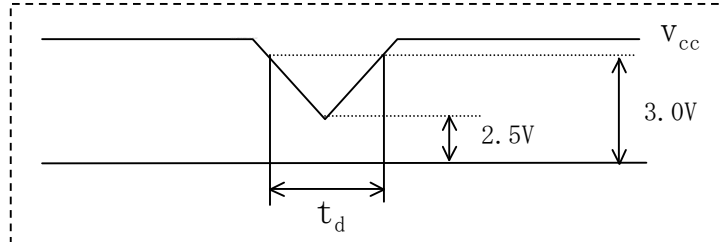
 V<sub>cc</sub>-dip conditions should also follow the On-off conditions for supply voltage

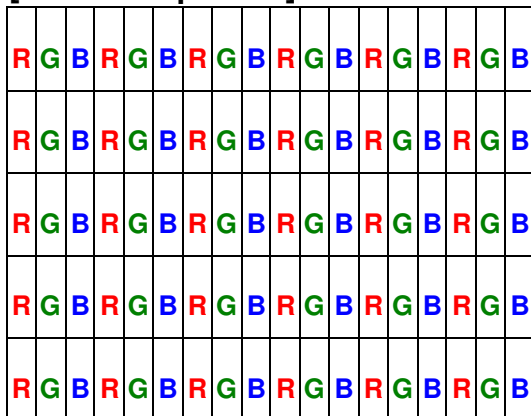
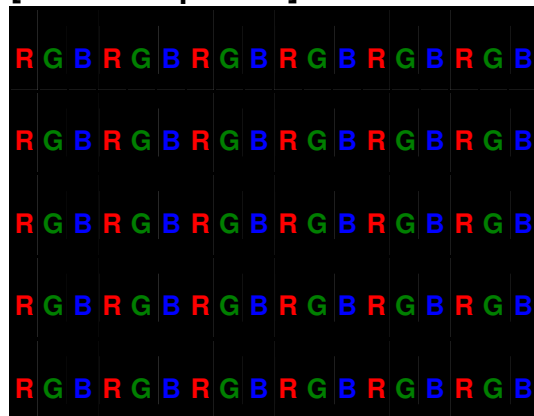
**[Note3] Test pattern of current dissipation**
**[Full white pattern] VDD=+3.3V**

**[Full black pattern] VDD=+3.3V**

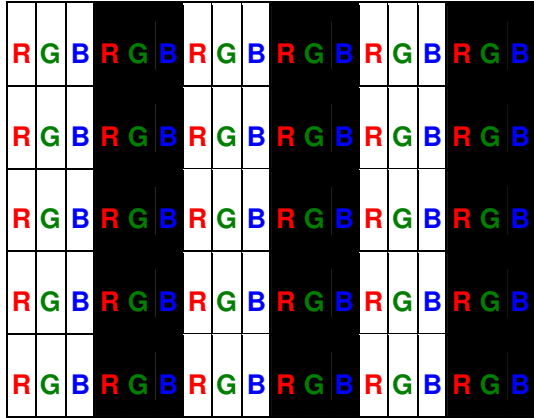

[1 line on/off pattern] VDD=+3.3V

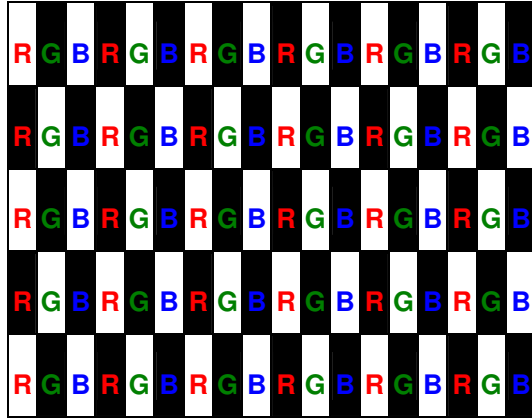

[1 dot on/off pattern] VDD=+3.3V



[32x32 Mosaic pattern] VDD=+3.3V

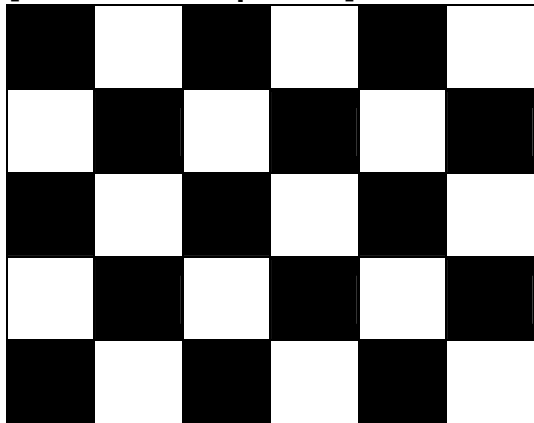

## 6-2. Backlight driving

The backlight system is an edge-lighting type with single CCFT (Cold Cathode Fluorescent Tube).

The characteristics of the lamp are shown in the following table.

Parameter	Symbol	Min.	Typ.	Max.	Unit	Remark
Lamp current range	$I_L$	3.0	6.0	6.5	mArms	[Note1]
Lamp voltage	$V_L$	585	650	715	Vrms	
Lamp power consumption	$P_L$	—	4.08	—	W	$I_L=6.0mA$ [Note2]
Lamp frequency	$F_L$	50	55	60	kHz	[Note3]
Kick-off voltage	$V_s$	—	—	1370	Vrms	$T_a=25^\circ C$
		—	—	1560	Vrms	$T_a=0^\circ C$ [Note4]
Lamp life time	$L_L$	10000	—	—	hour	[Note5]

[Note1] Lamp current is measured with current meter for high frequency as shown below.

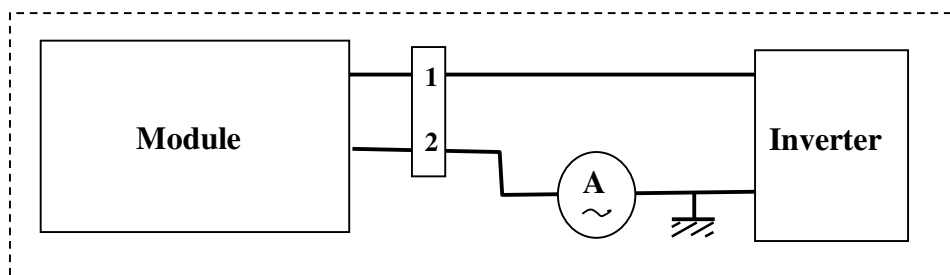

[Note2] Calculated Value for reference ( $I_L \times V_L$ )

[Note3] Lamp frequency may produce interference with horizontal synchronous frequency, and this may cause beat on the display. Therefore lamp frequency shall be detached as much as possible from the horizontal synchronous frequency and from the harmonics of horizontal synchronous to avoid interference.

[Note4] The voltage above this value should be applied to the lamp for more than 1 second to start-up. Otherwise the lamp may not be turned on.

[Note5] Lamp life time is defined as the time when either ① or ② occurs in the continuous operation under the condition of  $T_a = 25^\circ C$  and  $I_L = 6.0$  mArms.

- ① Brightness becomes 50 % of the original value under standard condition.
- ② Kick-off voltage at  $T_a = 0^\circ C$  exceeds maximum value.

[Note] The performance of the backlight, for example life time or brightness, is much influenced by the characteristics of the DC-AC inverter for the lamp. When you design or order the inverter, please make sure that a poor lighting caused by the mismatch of the backlight and the inverter (miss-lighting, flicker, etc.) never occur. When you confirm it, the module should be operated in the same condition as it is installed in your instrument.

**7. Timing characteristics of LCD module input signals**
**7-1. Timing characteristics**

(This is specified at digital outputs of LVDS driver.)

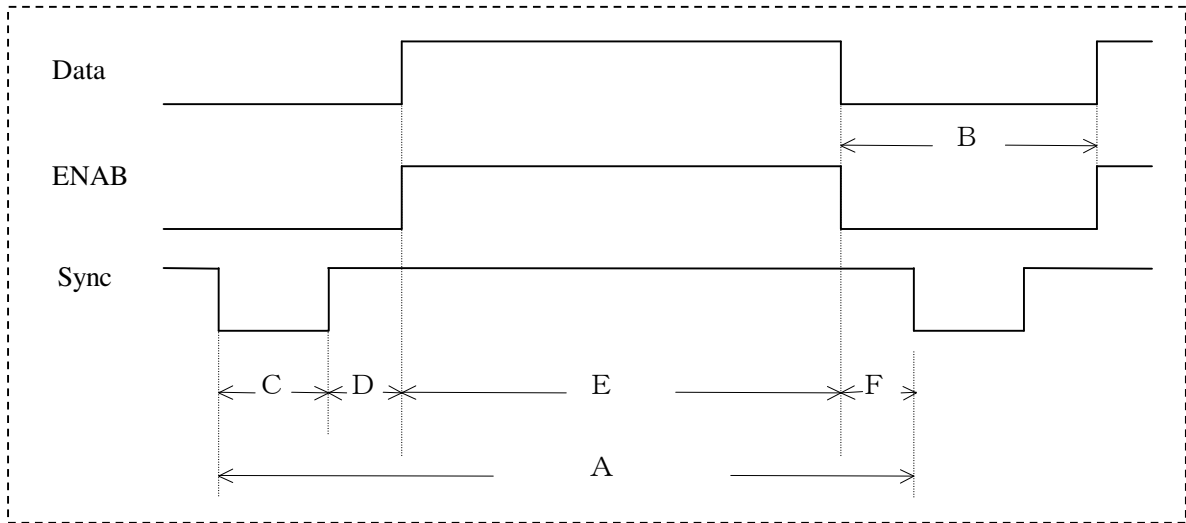

( Vertical )

Item (symbol)	Min.	Typ.	Max.	Unit	Remark
Vsync cycle ( $T_{VA}$ )		16.667		ms	Negative
	808	816	850	line	
Blanking period( $T_{VB}$ )	8	16		line	
Sync pulse width ( $T_{VC}$ )	2	4		line	
Back porch ( $T_{VD}$ )	5	8		line	
Sync pulse width + Back porch ( $T_{VC}+T_{VD}$ )	7	12	--	line	
Active display area ( $T_{VE}$ )	800	800	800	line	
Front porch ( $T_{VF}$ )	1	4		line	

( Horizontal )

Item (symbol)	Min.	Typ.	Max.	Unit	Remark
Hsync cycle ( $T_{HA}$ )		20.44		$\mu$ s	Negative
	1380	1408	1428	clock	
Blanking period ( $T_{HB}$ )	100	128		clock	
Sync pulse width ( $T_{HC}$ )	16	32		clock	
Back porch ( $T_{HD}$ )	68	75		clock	
Sync pulse width + Back porch ( $T_{HC} + T_{HD}$ )	84	107	--	clock	
Active display area ( $T_{HE}$ )	1280	1280	1280	clock	
Front porch ( $T_{HF}$ )	16	21		clock	

(Clock )

Item	Min.	Typ.	Max.	Unit	Remark
Frequency	67	68.9	72	MHz	[Note1]

[Note] In case of lower frequency, the deterioration of display quality, flicker etc., may be occurred.

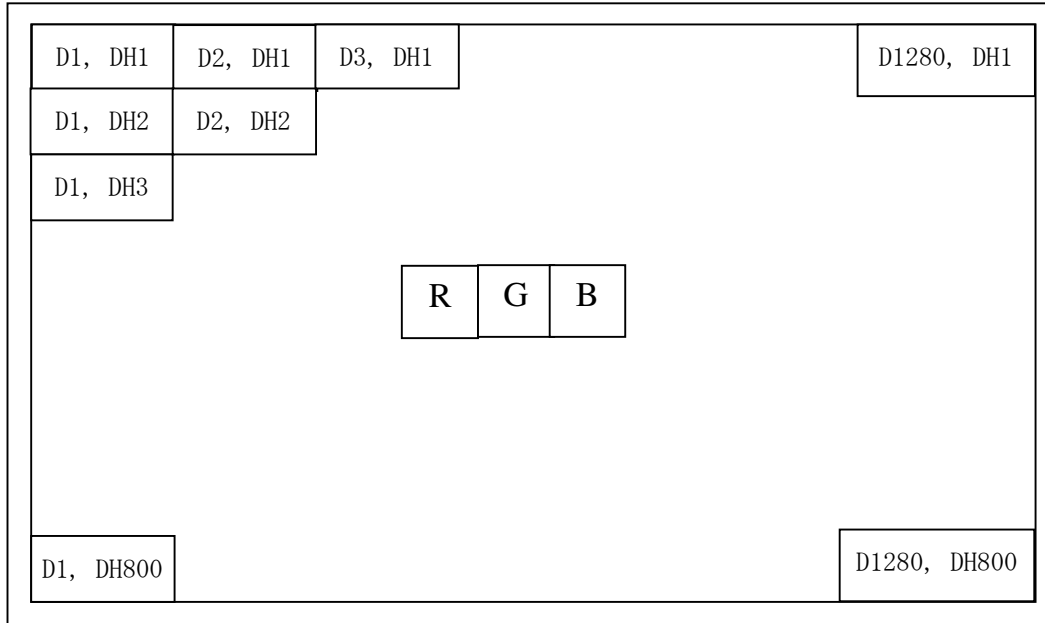
**7-2. Input Data Signals and Display Position on the screen**

**8. Input Signals, Basic Display Colors and Gray Scale of Each Color**

Colors & Gray scale	Data signal																			
	Gray Scale	R0	R1	R2	R3	R4	R5	G0	G1	G2	G3	G4	G5	B0	B1	B2	B3	B4	B5	
Basic Color	Black	—	0	0	0	0	0	0	0	0	0	0	0	0	0	0	0	0	0	0
	Blue	—	0	0	0	0	0	0	0	0	0	0	0	0	1	1	1	1	1	1
	Green	—	0	0	0	0	0	0	1	1	1	1	1	1	0	0	0	0	0	0
	Cyan	—	0	0	0	0	0	0	1	1	1	1	1	1	1	1	1	1	1	1
	Red	—	1	1	1	1	1	1	0	0	0	0	0	0	0	0	0	0	0	0
	Magenta	—	1	1	1	1	1	1	0	0	0	0	0	0	1	1	1	1	1	1
	Yellow	—	1	1	1	1	1	1	1	1	1	1	1	1	0	0	0	0	0	0
	White	—	1	1	1	1	1	1	1	1	1	1	1	1	1	1	1	1	1	1
Gray Scale of Red	Black	GS0	0	0	0	0	0	0	0	0	0	0	0	0	0	0	0	0	0	0
	↑	GS1	1	0	0	0	0	0	0	0	0	0	0	0	0	0	0	0	0	0
	Darker	GS2	0	1	0	0	0	0	0	0	0	0	0	0	0	0	0	0	0	0
	↑	↓				↓				↓				↓						
	↓	↓				↓				↓				↓						
	Brighter	GS61	1	0	1	1	1	1	0	0	0	0	0	0	0	0	0	0	0	0
	↓	GS62	0	1	1	1	1	1	0	0	0	0	0	0	0	0	0	0	0	0
	Red	GS63	1	1	1	1	1	1	0	0	0	0	0	0	0	0	0	0	0	0
Gray Scale of Green	Black	GS0	0	0	0	0	0	0	0	0	0	0	0	0	0	0	0	0	0	0
	↑	GS1	0	0	0	0	0	0	1	0	0	0	0	0	0	0	0	0	0	0
	Darker	GS2	0	0	0	0	0	0	0	1	0	0	0	0	0	0	0	0	0	0
	↑	↓				↓				↓				↓						
	↓	↓				↓				↓				↓						
	Brighter	GS61	0	0	0	0	0	0	1	0	1	1	1	1	0	0	0	0	0	0
	↓	GS62	0	0	0	0	0	0	0	1	1	1	1	1	0	0	0	0	0	0
	Green	GS63	0	0	0	0	0	0	1	1	1	1	1	1	0	0	0	0	0	0
Gray Scale of Blue	Black	GS0	0	0	0	0	0	0	0	0	0	0	0	0	0	0	0	0	0	0
	↑	GS1	0	0	0	0	0	0	0	0	0	0	0	0	1	0	0	0	0	0
	Darker	GS2	0	0	0	0	0	0	0	0	0	0	0	0	0	1	0	0	0	0
	↑	↓				↓				↓				↓						
	↓	↓				↓				↓				↓						
	Brighter	GS61	0	0	0	0	0	0	0	0	0	0	0	0	1	0	1	1	1	1
	↓	GS62	0	0	0	0	0	0	0	0	0	0	0	0	0	1	1	1	1	1
	Blue	GS63	0	0	0	0	0	0	0	0	0	0	0	0	1	1	1	1	1	1

0 : Low level voltage, 1 : High level voltage

Each basic color can be displayed in 64 gray scales from 6 bit data signals. According to the combination of total 18 bit data signals, the 262,144-color display can be achieved on the screen.

**9. EDID data structure**

This is the EDID (Extended Display Identification Data) data format to support displays as defined in the VESA Plug & Display.

Byte (decimal)	Byte (hex)	Field Name and Comments	Value (hex)	Value (binary)
<b>Header</b>				
0	0	Header	00	00000000
1	1	Header	FF	11111111
2	2	Header	FF	11111111
3	3	Header	FF	11111111
4	4	Header	FF	11111111
5	5	Header	FF	11111111
6	6	Header	FF	11111111
7	7	Header	00	00000000
<b>Vender/Product ID / EDID Version</b>				
8	8	EISA manufacturer code=QDS	44	01000100
9	9	EISA manufacturer code(Compressed ASCII)	93	10010011
10	0A	Product code (44) LSB	2C	00101100
11	0B	Product code MSB	00	00000000
12	0C	ID (32bit) Serial No (zero if not used)	00	00000000
13	0D	ID (32bit) Serial No (zero if not used)	00	00000000
14	0E	ID (32bit) Serial No (zero if not used)	00	00000000
15	0F	ID (32bit) Serial No (zero if not used)	00	00000000
16	10	Week of manufacture	00	00000000
17	11	Year of manufacture – 1990 (ex. 2005-1990=15)	0F	00001111
18	12	EDID structure version # = 1	01	00000001
19	13	EDID revision # = 3	03	00000011
<b>Display Parameter</b>				
20	14	Video I/P definition = Digital I/P	80	10000000
21	15	Max H image size (cm) =30cm	1E	00011110
22	16	Max V image size (cm) =19cm	13	00010011
23	17	Display gamma ( 2.2×100 ) –100	78	01111000
24	18	Features (no DPMS,Active off,RGB,timing BLK1)	0A	00001010
<b>Panel Color Coordinates</b>				
25	19	Red/Green Low bits (RxRy/GxGy)	D7	11010111
26	1A	Blue/White Low bits (BxBY/WxWy)	E0	11100000
27	1B	Red X Rx=0.57	91	10010001
28	1C	Red Y Ry=0.33	54	01010100
29	1D	Green X Gx=0.31	4F	01001111
30	1E	Green Y Gy=0.55	8C	10001100

31	1F	Blue X Bx=0.16	28	00101000
32	20	Blue Y By=0.135	22	00100010
33	21	White X Wx=0.313	50	01010000
34	22	White Y Wy=0.329	54	01010100
<b>Established Timings</b>				
35	23	Established timings 1 (00h if not used)	00	00000000
36	24	Established timings 2 (00h if not used)	00	00000000
<b>Standard Timing ID</b>				
37	25	Manufacturer's timings( 00h if not used)	00	00000000
38	26	Standard timing ID1 (01h if not used)	01	00000001
39	27	Standard timing ID1 (01h if not used)	01	00000001
40	28	Standard timing ID2 (01h if not used)	01	00000001
41	29	Standard timing ID2 (01h if not used)	01	00000001
42	2A	Standard timing ID3 (01h if not used)	01	00000001
43	2B	Standard timing ID3 (01h if not used)	01	00000001
44	2C	Standard timing ID4 (01h if not used)	01	00000001
45	2D	Standard timing ID4 (01h if not used)	01	00000001
46	2E	Standard timing ID5 (01h if not used)	01	00000001
47	2F	Standard timing ID5 (01h if not used)	01	00000001
48	30	Standard timing ID6 (01h if not used)	01	00000001
49	31	Standard timing ID6 (01h if not used)	01	00000001
50	32	Standard timing ID7 (01h if not used)	01	00000001
51	33	Standard timing ID7 (01h if not used)	01	00000001
52	34	Standard timing ID8 (01h if not used)	01	00000001
53	35	Standard timing ID8 (01h if not used)	01	00000001
<b>Timing Descriptor #1</b>				
54	36	Pixel Clock(68.9M)/10,000 (LSB)	EA	11101010
55	37	Pixel Clock(68.9M)/10,000 (MSB)	1A	00011010
56	38	Horizontal Active=1280 pixels (lower 8 bits)	00	00000000
57	39	Horizontal Blanking=128 pixels (lower 8bits)	80	10000000
58	3A	Horizontal Active: Horizontal Blanking (upper 4:4 bits)	50	01010000
59	3B	Vertical Active =800 lines (lower 8bits)	20	00100000
60	3C	Vertical Blanking=16 lines (lower 8bits)	10	00010000
61	3D	Vertical Active : Vertical Banking (upper 4:4 bits)	30	00110000
62	3E	Horizontal Sync.Offset =21 pixels (lower 8bits)	15	00010101
63	3F	Horizontal Sync.Width=32 pixels (lower 8bits)	20	00100000
64	40	Vertical Sync. Offset: lines Sync. Width (lower 4bits)	44	01000100
65	41	Horizontal/Vertical Sync Offset/Width (upper 2 bits)	00	00000000
66	42	Horizontal Image Size=303.7mm (lower 8 bits)	30	00110000
67	43	Vertical Image Size=189.8mm (lower 8 bits)	BE	10111110

68	44	Horizontal : Vertical Image Size (upper 4:4 bits)	10	00010000
69	45	Horizontal Border (zero for internal LCD)	00	00000000
70	46	Vertical Border (zero for internal LCD)	00	00000000
71	47	Non-interlaced,Normal,no stereo,Separate sync,H/V pol negatives	18	00011000
<b>Timing Descriptor #2 MANUFACTURER SPECIFIED RANGE TIMING Descriptor</b>				
72	48	Flag	00	00000000
73	49	Flag	00	00000000
74	4A	Flag	00	00000000
75	4B	Data Type Tag : Descriptor Defined by Manufacturer	0F	00001111
76	4C	Flag	00	00000000
77	4D	Value=HSPW min/2 (pixel clks)	08	00001000
78	4E	Value=HSPW max/2 (pixel clks)	00	00000000
79	4F	Value=Thbp min/2 (pixel clks)	2A	00101010
80	50	Value=Thbp max/2 (pixel clks)	00	00000000
81	51	Value=VSPW min/2 (line pulses)	01	00000001
82	52	Value=VSPW max/2 (line pulses)	00	00000000
83	53	Value=Tvbp min/2 (line pulses)	04	00000100
84	54	Value=Tvbp max/2 (line pulses)	00	00000000
85	55	Thp min=value*2+HA pixel clks (pixel clks)	32	00110010
86	56	Thp max=value*2+HA pixel clks (pixel clks)	4A	01001010
87	57	Tvp min=value*2+VA lines	04	00000100
88	58	Tvp max=value*2+VA lines	19	00011001
89	59	Module revision	01	00000001
<b>Timing Descriptor #3 : ASCII String : Supplier Name</b>				
90	5A	Flag	00	00000000
91	5B	Flag	00	00000000
92	5C	Flag	00	00000000
93	5D	Data Type Tag : Module serial number	FE	11111110
94	5E	Flag	00	00000000
95	5F	ASCII (Q)	51	01010001
96	60	ASCII (U)	55	01010101
97	61	ASCII (A)	41	01000001
98	62	ASCII (N)	4E	01001110
99	63	ASCII (T)	54	01010100
100	64	ASCII (A)	41	01000001
101	65	ASCII (D)	44	01000100
102	66	ASCII (I)	49	01001001
103	67	ASCII (S)	53	01010011
104	68	ASCII (P)	50	01010000
105	69	ASCII (L)	4C	01001100



106	6A	ASCII (A)	41	01000001
107	6B	ASCII (Y)	59	01011001
<b>Timing Descriptor #4 ASCII String : Supplier P/N</b>				
108	6C	Flag	00	00000000
109	6D	Flag	00	00000000
110	6E	Flag	00	00000000
111	6F	Data Type Tag : Module Name	FE	11111110
112	70	Flag	00	00000000
113	71	Q	51	01010001
114	72	D	44	01000100
115	73	1	31	00110001
116	74	4	34	00110100
117	75	T	54	01010100
118	76	L	4C	01001100
119	77	0	30	00110000
120	78	1	31	00110001
121	79	Product revision (ex :3)	33	00110011
122	7A	Terminate with ASCII code 0Ah	0A	00001010
123	7B	Pad field with ASCII code 20h	20	00100000
124	7C	Pad field with ASCII code 20h	20	00100000
125	7D	Pad field with ASCII code 20h	20	00100000
126	7E	Extension flag	00	00000000
127	7F	Checksum	31	00110001

**10.Optical Characteristics**
**Ta=25°C, Vcc=+3.3V**

Parameter		Symbol	Condition	Min.	Typ.	Max.	Unit	Remark
Viewing Angle Range	Horizontal	R, L	CR>10	40	45	—	Deg.	[Note1,4]
	Vertical	Up		15	20	—	Deg.	
		Dn		30	35	—	Deg.	
Contrast ratio		C R n	$\theta = 0^\circ$	300				[Note2,4]
Response Time	Rise	Tr	$\theta = 0^\circ$	—	10		ms	[Note3,4]
	Decay	Td		—	15		ms	
Chromaticity of White		Wx Wy		0.283 0.299	0.313 0.329	0.343 0.359		[Note4]
Chromaticity of Red		Rx Ry		0.540 0.300	0.570 0.330	0.600 0.360		[Note4]
Chromaticity of Green		Gx Gy		0.280 0.520	0.310 0.550	0.340 0.580		[Note4]
Chromaticity of Blue		Bx By		0.130 0.105	0.160 0.135	0.190 0.165		[Note4]
Luminance of white [Note5]		Y L 2	5 points Center	150	185	—	Cd/m <sup>2</sup>	IL = 6.0 mArms FL=55kHz
White Uniformity		$\delta W1$	5 Points	—	—	1.25		[Note5]
		$\delta W2$	13 points	—	—	1.45		

The optical characteristics shall be measured in a dark room or equivalent state with the method shown in Fig.3.

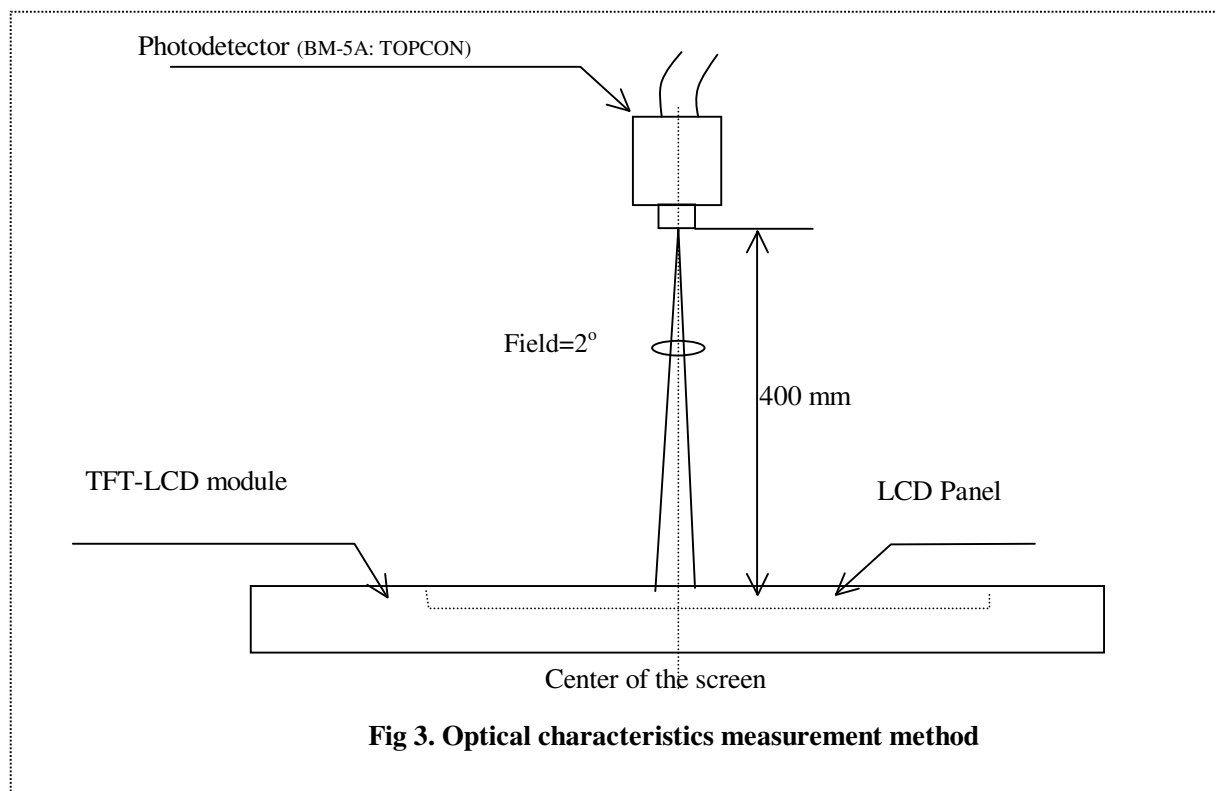
**Fig 3. Optical characteristics measurement method**

[Note1] Definitions of viewing angle range:

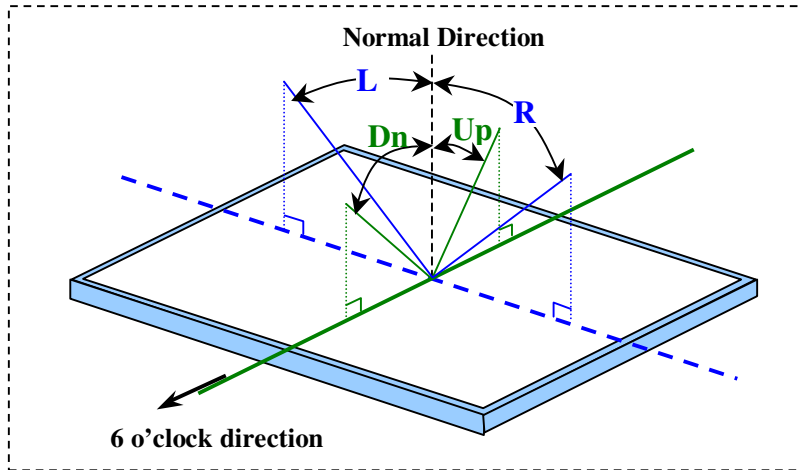

[Note2] Definition of contrast ratio:

The contrast ratio is defined as the following.

$$\text{Contrast Ratio (CR)} = \frac{\text{Luminance (brightness) with all pixels white}}{\text{Luminance (brightness) with all pixels black}}$$

[Note3] Definition of response time:

The response time is defined as the following figure and shall be measured by switching the input signal for "black" and "white" .

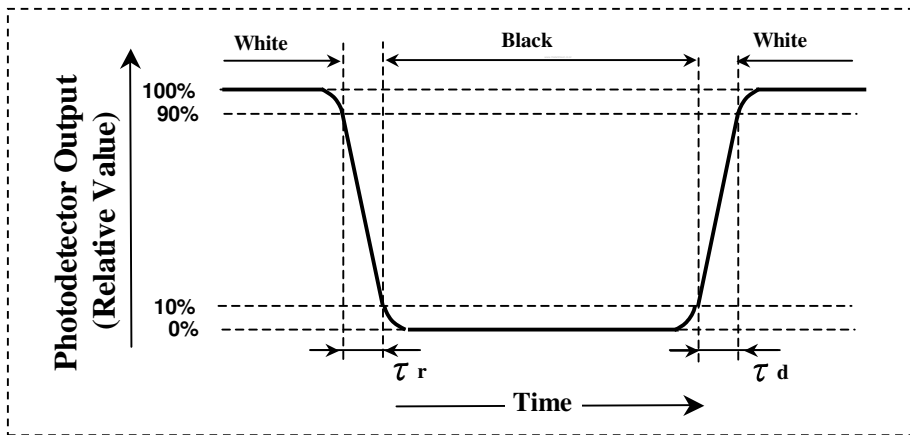

[Note4] This shall be measured at center of the screen.

[Note5] Definition of white uniformity:

$$\delta_w = \frac{\text{Maximum Luminance of 5/13 points}}{\text{Minimum Luminance of 5/13 points}}$$

\*1) 5 Points are A~E

\*1) 13 Points are A~M

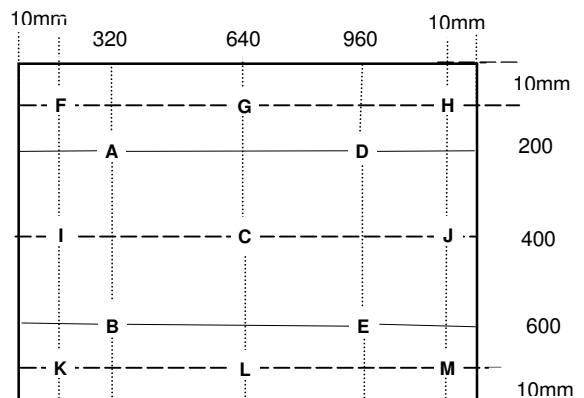

## **11. Display Quality**

**The display quality of the color TFT-LCD module shall be in compliance with the Incoming Inspection Standard.**

## **12. Handling Precautions**

- a) Be sure to turn off the power supply when inserting or disconnecting the cable.**
- b) Be sure to design the cabinet so that the module can be installed without any extra stress such as warp or twist.**
- c) Since the front polarizer is easily damaged, pay attention not to scratch it.**
- d) Wipe off water drop immediately. Long contact with water may cause discoloration or spots.**
- e) When the panel surface is soiled, wipe it with absorbent cotton or other soft cloth.**
- f) Since the panel is made of glass, it may break or crack if dropped or bumped on hard surface. Handle with care.**
- g) Since CMOS LSI is used in this module, take care of static electricity and injure the human earth when handling.**
- h) Observe all other precautionary requirements in handling components.**
- i) This module has its circuitry PCBs on the rear side and should be handled carefully in order not to be stressed.**
- j) Laminated film is attached to the module surface to prevent it from being scratched. Peel the film off slowly just before the use with strict attention to electrostatic charges. Ionized air shall be blown over during the action. Blow off the 'dust' on the polarizer by using an ionized nitrogen gun, etc..**
- k) Cold cathode fluorescent lamp in LCD panel contains a small amount of mercury, please follow local ordinance or regulation for disposal.**
- l) Mounting screw hole can stand torque 1.3~1.5 Kgf-cm.**

**13. Reliability test items**

No.	Test item	Conditions
1	High temperature storage test	Ta = 60 °C 240h
2	Low temperature storage test	Ta = -25 °C 240h
3	High temperature & High humidity operation test	Ta = 40 °C ; 90%RH 240h, (As remark #3) (No condensation)
4	High temperature operation test	Ta = 50 °C 240h (The panel temp. must be less than 60 °C)
5	Low temperature operation test	Ta = 0 °C 240h
6	Vibration test (non - operating)	Frequency : 10 ~ 500 Hz, 1.5Grms Test period: 3hrs (1Hr for each of X, Y, Z)
7	Shock test (Non- operating)	Max. Gravity: 220G Pulse width: 2 ms, Half sine wave Direction: ±X, ±Y, ±Z ; Once for each direction.
8	Altitude test (Operating)	0-10000 feet (3048m) / -20 °C / +60 °C / 24hr
9	Altitude test (Storage)	0-40000 feet (12192m) / 0 °C / +55 °C / 24hr

**Remark:**

- (1) A failure is defined as the appearance of pixel failed on any color layer or the appearance of horizontal or vertical lines, bars etc.
- (2) Low temperature storage “ Panel must return to operating temperature range prior to activation.”
- (3) Hi temperature / Humidity test  
Max. wet-bulb temperature is less than 39°C ; At glass temperature high than 40 °C.  
Temperature and relative humidity range is shown in the figure below.

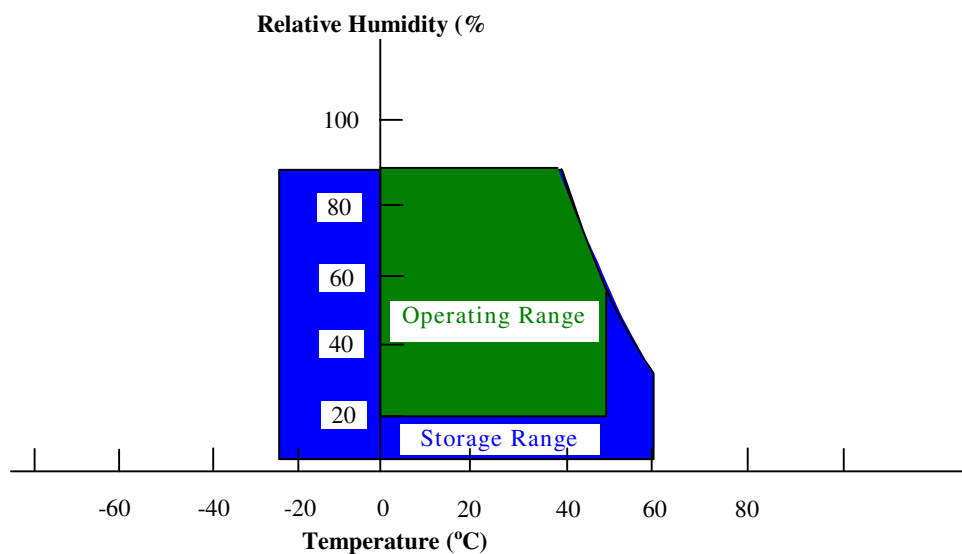

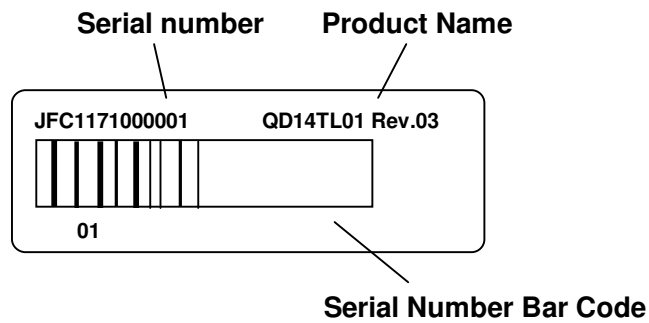
**14. Others****1) Lot No. Label:**

- 2) Adjusting volume has been set optimally before shipment, so do not change any adjusted value. If adjusted value is changed, the specification may not be satisfied.
- 3) Disassembling the module can cause permanent damage and should be strictly avoided.
- 4) Please be careful since image retention may occur when a fixed pattern is displayed for a long time.
- 5) If any problem occurs in relation to the description of this specification, it shall be resolved through discussion with spirit of cooperation.

### 15. Packing form

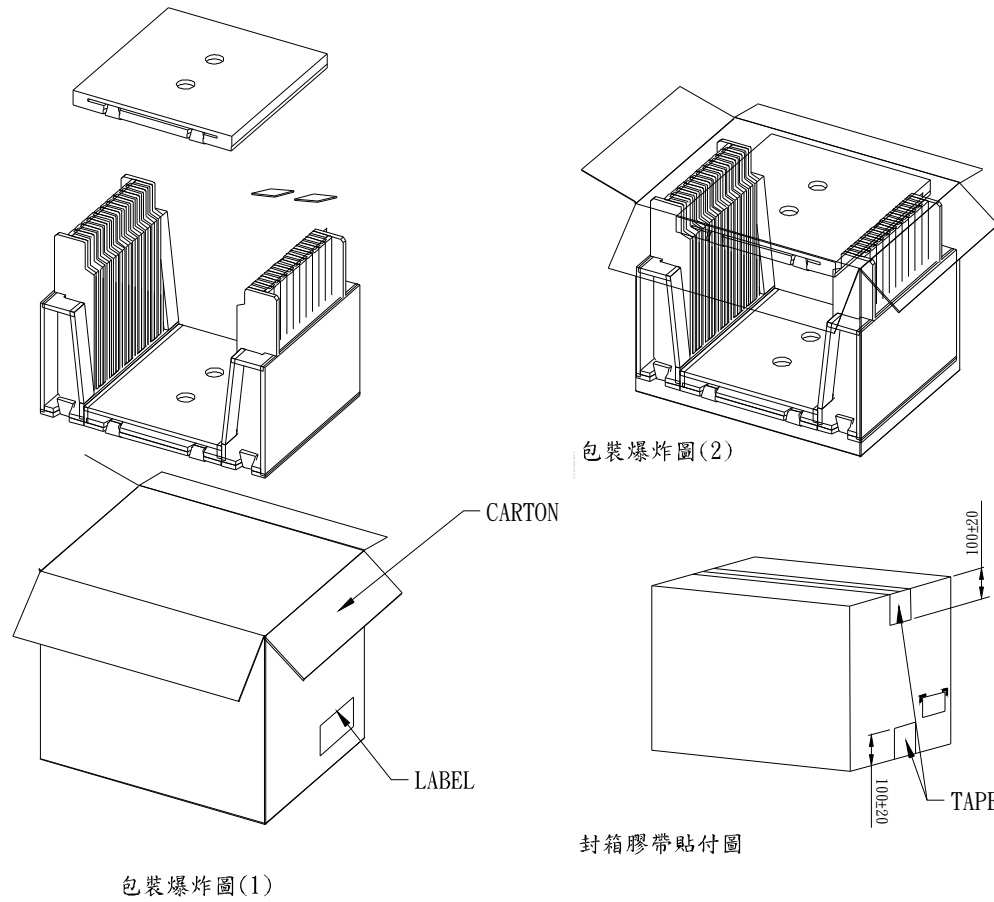

### 16. Mechanical Outline Dimension

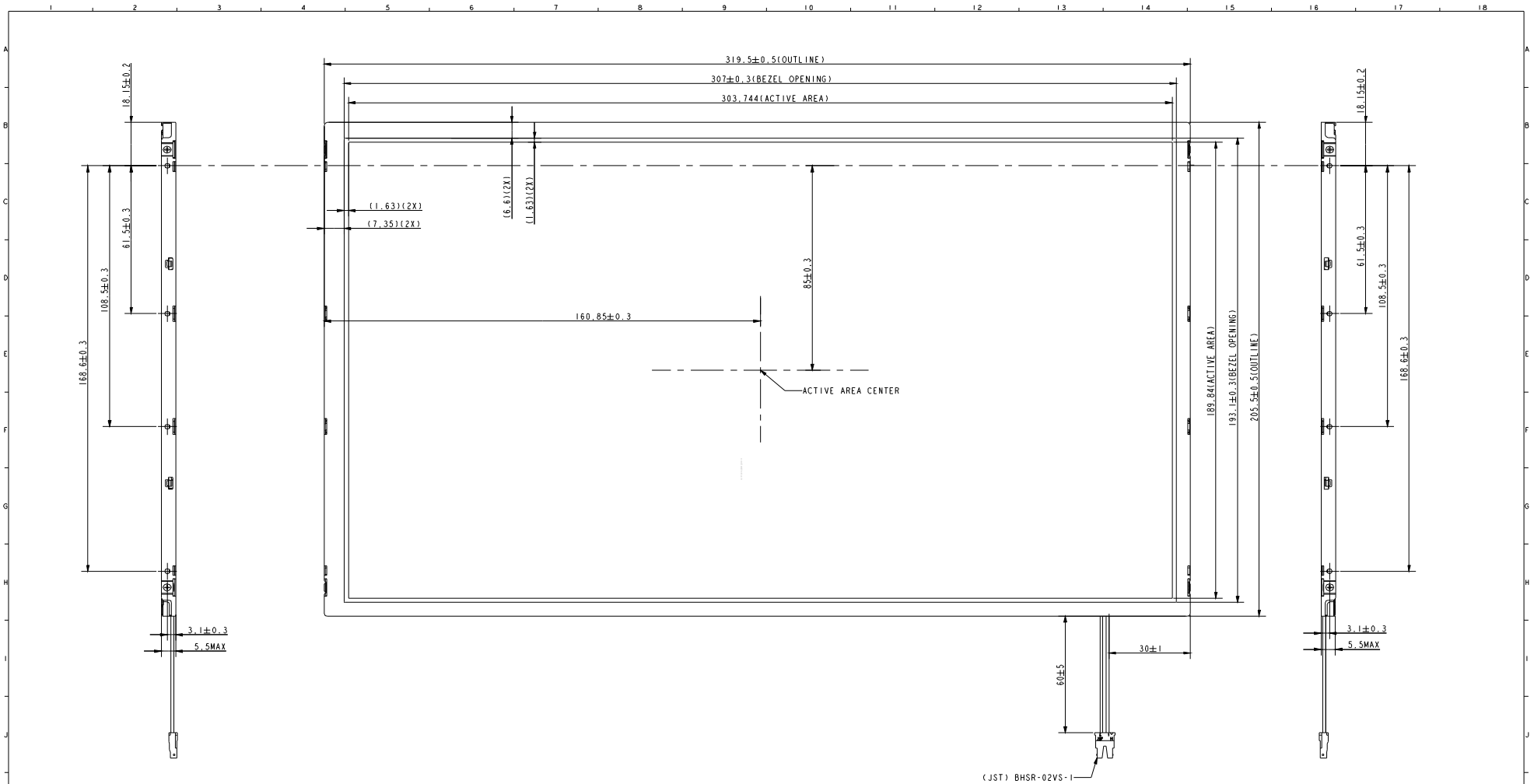

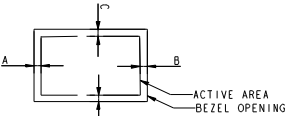

NOTE:  
 1. BILIGQUITY TOLERANCE OF DISPLAY AREA SHOWN AS RIGHT:  
 X-DIRECTION: |A-B| ≤ 1.0mm  
 Y-DIRECTION: |C-D| ≤ 1.0mm



Quanta Display Inc.				ORIGINAL MODEL	N14V2
CONFIDENTIAL				MATERIAL	
UNIT	mm	SHEET	1 OF 2		
SCALE	1:000	SIZE	A2		
DATE	2005.01.17			DRAWING NAME	OUTLINE DIMENSION
DESIGN	DSN CK	DSN CK	ENG APPD	PART NUMBER	
NO	DCN	DATE	DESCRIPTION	ZONE	JENNY
REVISION LIST					
RELEASE LEVEL					
VER.					+

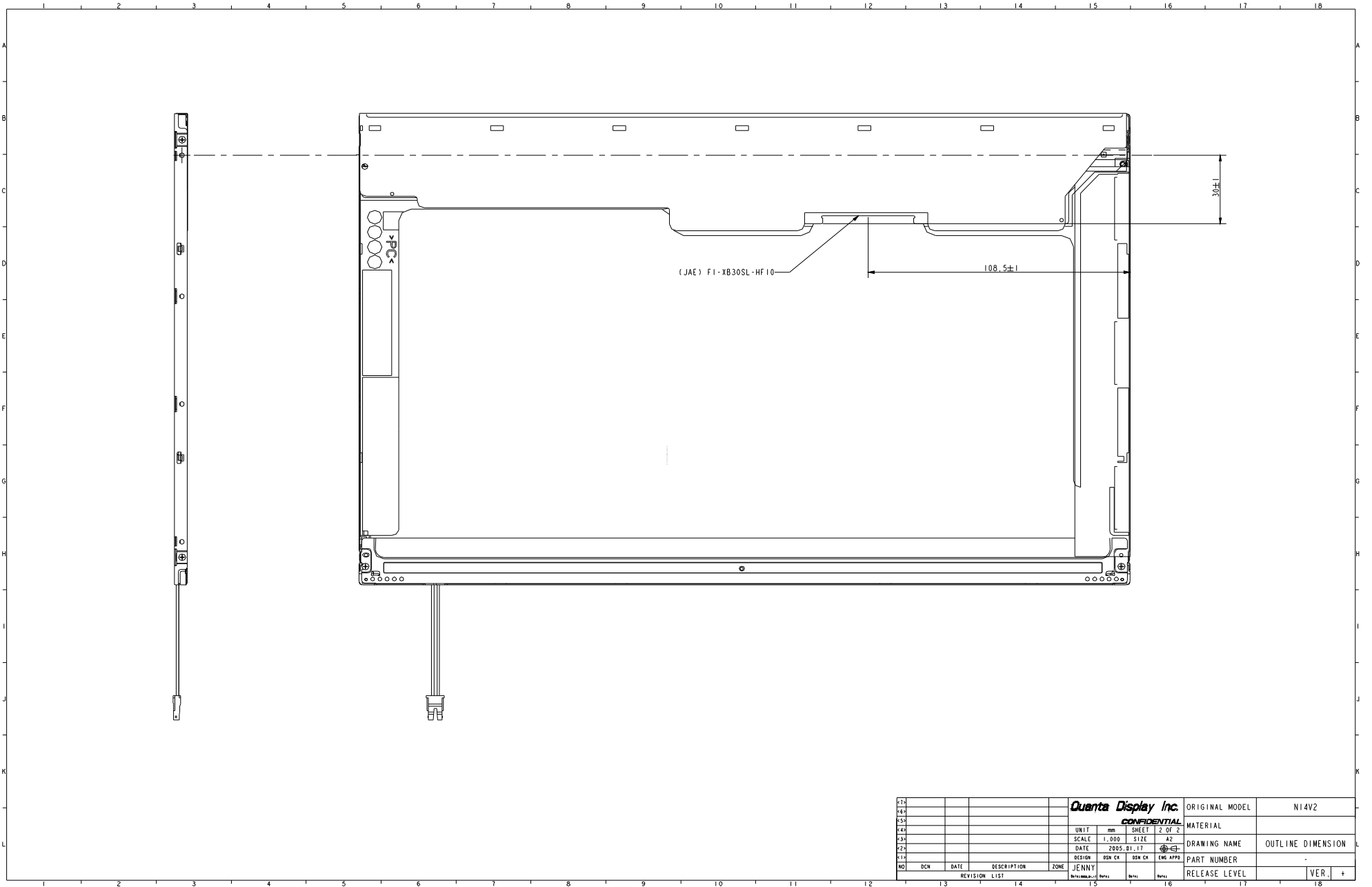



Quanta Display Inc.										ORIGINAL MODEL	N14V2
CONFIDENTIAL										MATERIAL	
				UNIT	mm	SHEET	2 OF 2		DRAWING NAME	OUTLINE DIMENSION	
				SCALE	1:000	SIZE	A2		PART NUMBER	-	
				DATE	2005.01.17				RELEASE LEVEL	VER. 1	
				DESIGN	DSN CR	DSN CR	ENG APPS				
NO	DCN	DATE	DESCRIPTION	ZONE	JENNY						
REVISION LIST											