

Dual IGBT HVIGBT Module 500 Amperes/3300 Volts

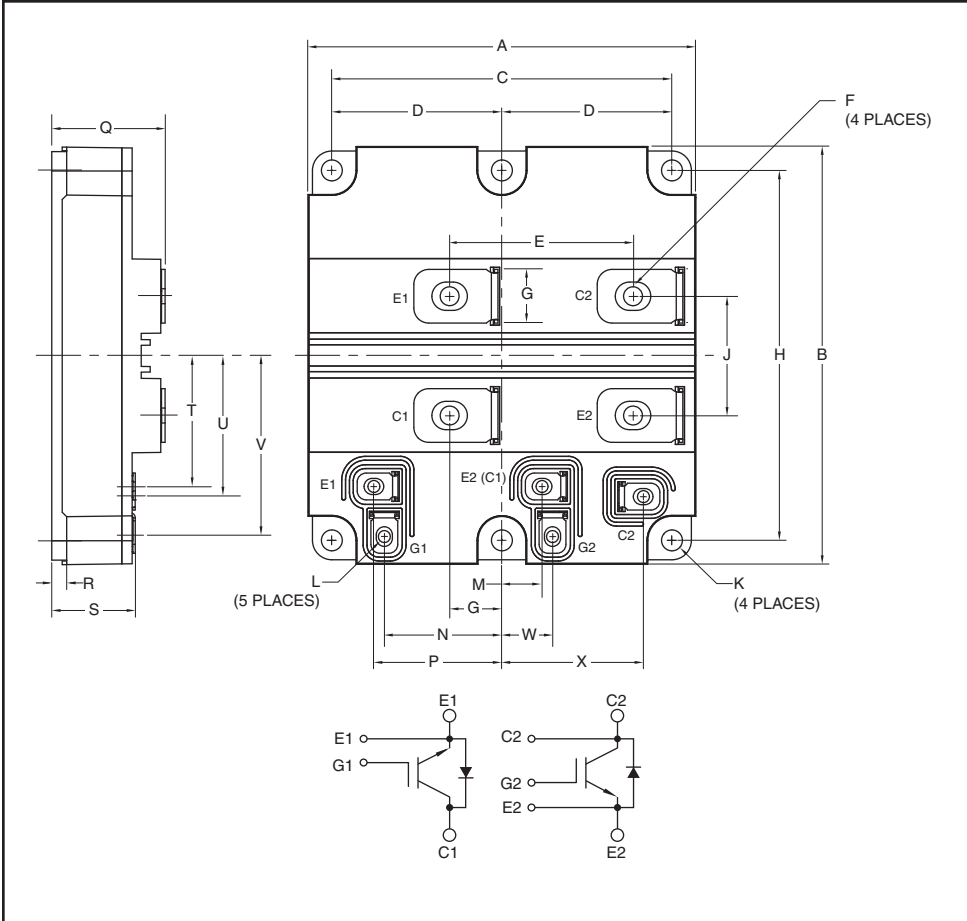

Description:

Powerex HVIGBTs feature highly insulating housings that offer enhanced protection by means of greater creepage and strike clearance distance for many demanding applications like medium voltage drives and auxiliary traction applications.

Features:

- 55 to 150°C Extended Temperature Range
- 100% Dynamic Tested
- 100% Partial Discharge Tested
- Advanced Mitsubishi R-Series Chip Technology
- AlSiC Baseplate
- Aluminum Nitride (AlN) Ceramic Substrate for Low Thermal Impedance
- Complementary Line-up in Expanding Current Ranges to Mitsubishi HVIGBT Power Modules
- Rugged SWSOA and RRSOA

Applications:

- High Voltage Power Supplies
- Medium Voltage Drives
- Motor Drives
- Traction

Outline Drawing and Circuit Diagram

Dimensions	Inches	Millimeters
A	5.11	130.0
B	5.51	140.0
C	4.49	114.0
D	2.24	57.0
E	2.42	61.5
F	M8	M8 Metric
G	0.71	18.0
H	4.88	124.0
J	1.57	40.0
K	0.27	7.0 Dia.
L	M4	M4 Metric

Dimensions	Inches	Millimeters
M	0.51	13.0
N	1.57	39.9
P	1.71	43.4
Q	1.49	38.0
R	0.20	5.0
S	1.10	28.0
T	1.72	43.8
U	1.86	47.2
V	2.39	60.6
W	0.65	16.5
X	1.85	47.0

QID3350001
Dual IGBT HVIGBT Module
 500 Amperes/3300 Volts

Absolute Maximum Ratings, $T_j = 25\text{ }^\circ\text{C}$ unless otherwise specified

Ratings	Symbol	QID3350001	Units
Collector-Emitter Voltage ($V_{GE} = 0V, T_j = -40$ to $+150^\circ\text{C}$)	V_{CES}	3300	Volts
Collector-Emitter Voltage ($V_{GE} = 0V, T_j = -50^\circ\text{C}$)	V_{CES}	3200	Volts
Junction Temperature	T_j	-50 to 150	$^\circ\text{C}$
Operating Junction Temperature	T_{jop}	-50 to 150	$^\circ\text{C}$
Storage Temperature	T_{stg}	-55 to 150	$^\circ\text{C}$
Gate-Emitter Voltage ($V_{CE} = 0V$)	V_{GES}	± 20	Volts
Collector Current ($T_C = 92^\circ\text{C}$)	I_C	500	Amperes
Peak Collector Current (Pulse)	I_{CM}	1000^{*1}	Amperes
Diode Forward Current ^{*2}	I_F	500	Amperes
Diode Forward Surge Current (Pulse) ^{*2}	I_{FM}	1000^{*1}	Amperes
Maximum Collector Dissipation ($T_C = 25^\circ\text{C}$, IGBT Part, $T_{j(max)} \leq 150^\circ\text{C}$)	P_C	4500	Watts
Mounting Torque, M4/M8 Terminal Screws	—	2/15	N·m
Mounting Torque, M6 Mounting Screws	—	6	N·m
Module Weight (Typical)	—	900	Grams
Isolation Voltage (Charged Part to Baseplate, AC 60Hz 1 min.)	V_{iso}	6	kVolts
Partial Discharge ($V_1 = 3500 V_{rms}, V_2 = 2600 V_{rms}, f = 60\text{Hz}$ (Acc. to IEC 1287))	Q_{pd}	10	pC
Maximum Short-Circuit Pulse Width, ($V_{CC} \leq 2600V, V_{CE} \leq V_{CES}, V_{GE} = +15V/-8V, T_j = 150^\circ\text{C}$)	t_{psc}	10	μs

Electrical Characteristics, $T_j = 25\text{ }^\circ\text{C}$ unless otherwise specified

Characteristics	Symbol	Test Conditions	Min.	Typ.	Max.	Units
Collector-Cutoff Current	I_{CES}	$V_{CE} = V_{CES}, V_{GE} = 0V, T_j = 25^\circ\text{C}$	—	—	2.0	mA
		$V_{CE} = V_{CES}, V_{GE} = 0V, T_j = 125^\circ\text{C}$	—	10	20	mA
Gate Leakage Current	I_{GES}	$V_{GE} = V_{GES}, V_{CE} = 0V$	—	—	0.5	μA
Gate-Emitter Threshold Voltage	$V_{GE(th)}$	$I_C = 40\text{mA}, V_{CE} = 10V$	5.7	6.2	6.7	Volts
Collector-Emitter Saturation Voltage	$V_{CE(sat)}$	$I_C = 500\text{A}, V_{GE} = 15V, T_j = 25^\circ\text{C}$	—	2.7^{*3}	2.85	Volts
		$I_C = 500\text{A}, V_{GE} = 15V, T_j = 125^\circ\text{C}$	—	3.1	3.60	Volts
		$I_C = 500\text{A}, V_{GE} = 15V, T_j = 150^\circ\text{C}$	—	3.6	—	Volts
Total Gate Charge	Q_G	$V_{CC} = 1800V, I_C = 500\text{A}, V_{GE} = 15V$	—	4.4	—	μC
Emitter-Collector Voltage ^{*2}	V_{EC}	$I_E = 500\text{A}, V_{GE} = 0V, T_j = 25^\circ\text{C}$	—	2.4	3.0	Volts
		$I_E = 500\text{A}, V_{GE} = 0V, T_j = 125^\circ\text{C}$	—	2.5	3.2	Volts
		$I_E = 500\text{A}, V_{GE} = 0V, T_j = 150^\circ\text{C}$	—	2.4	—	Volts

*1 Pulse width and repetition rate should be such that device junction temperature (T_j) does not exceed $T_{j(max)}$ rating.

*2 Represents characteristics of the anti-parallel, emitter-to-collector free-wheel diode (FWDI).

*3 Pulse width and repetition rate should be such that device junction temperature rise is negligible.

QID3350001
Dual IGBT HVIGBT Module
 500 Amperes/3300 Volts

Electrical Characteristics, $T_j = 25\text{ }^\circ\text{C}$ unless otherwise specified

Characteristics	Symbol	Test Conditions	Min.	Typ.	Max.	Units
Input Capacitance	C_{ies}		—	58	—	nF
Output Capacitance	C_{oes}	$V_{GE} = 0V, V_{CE} = 10V$	—	3.6	—	nF
Reverse Transfer Capacitance	C_{res}		—	1.6	—	nF
Turn-on Delay Time	$t_{d(on)}$	$V_{CC} = 1800V, I_C = 500A,$	—	1.1	—	μs
Rise Time	t_r	$V_{GE} = \pm 15V,$	—	0.31	—	μs
Turn-off Delay Time	$t_{d(off)}$	$R_{G(on)} = 5.8\Omega, R_{G(off)} = 20\Omega,$	—	3.0	—	μs
Fall Time	t_f	$L_S = 100nH, \text{ Inductive Load}$	—	0.33	—	μs
Turn-on Switching Energy	$E_{on} (10\%)$	$T_j = 125^\circ\text{C}, I_C = 500A, V_{GE} = \pm 15V,$	—	760	—	mJ/P
Turn-off Switching Energy	$E_{off} (10\%)$	$R_{G(on)} = 5.8\Omega, R_{G(off)} = 20\Omega,$ $V_{CC} = 1800V, L_S = 100nH, \text{ Inductive Load}$	—	680	—	mJ/P
Diode Reverse Recovery Time ^{*2}	t_{rr}	$V_{CC} = 1800V, I_E = 500A,$	—	700	—	ns
Diode Reverse Recovery Charge ^{*2}	Q_{rr}	$V_{GE} = \pm 15V, R_{G(on)} = 5.8\Omega,$	—	470 ^{*1}	—	μC
Diode Reverse Recovery Energy	$E_{rec} (10\%)$	$L_S = 100nH, \text{ Inductive Load}, T_j = 125^\circ\text{C}$	—	485	—	mJ/P
Stray Inductance	L_{SCE}		—	25	—	nH
Lead Resistance Terminal-Chip	R_{CE}		—	TBD	—	m Ω

Thermal and Mechanical Characteristics, $T_j = 25\text{ }^\circ\text{C}$ unless otherwise specified

Characteristics	Symbol	Test Conditions	Min.	Typ.	Max.	Units
Thermal Resistance, Junction to Case ^{*4}	$R_{th(j-c)} Q$	Per IGBT	—	—	0.0275	$^\circ\text{C/W}$
Thermal Resistance, Junction to Case ^{*4}	$R_{th(j-c)} D$	Per FWDi	—	—	0.052	$^\circ\text{C/W}$
Contact Thermal Resistance, Case to Fin	$R_{th(c-f)}$	Per Module, Thermal Grease Applied, $\lambda_{grease} = 1W/mK$	—	0.008	—	$^\circ\text{C/W}$

^{*1} Pulse width and repetition rate should be such that device junction temperature (T_j) does not exceed $T_{j(max)}$ rating.

^{*2} Represents characteristics of the anti-parallel, emitter-to-collector free-wheel diode (FWDi).

^{*4} T_C measurement point is just under the chips.

QID3350001
Dual IGBT HVIGBT Module
 500 Amperes/3300 Volts

OUTPUT CHARACTERISTICS (TYPICAL)

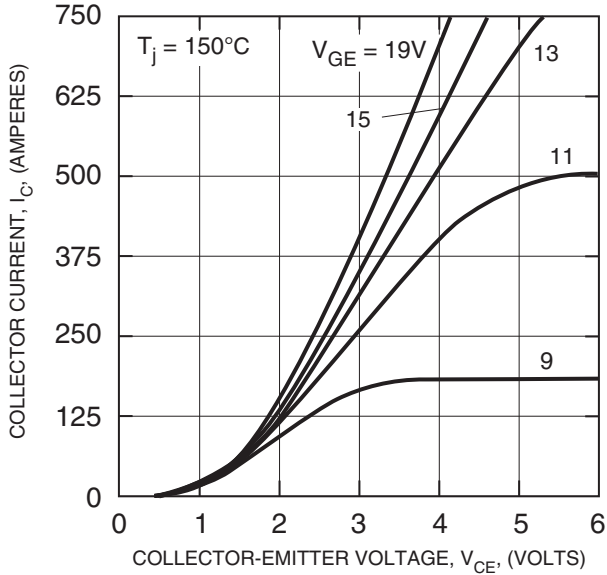

COLLECTOR-EMITTER SATURATION VOLTAGE CHARACTERISTICS (TYPICAL)

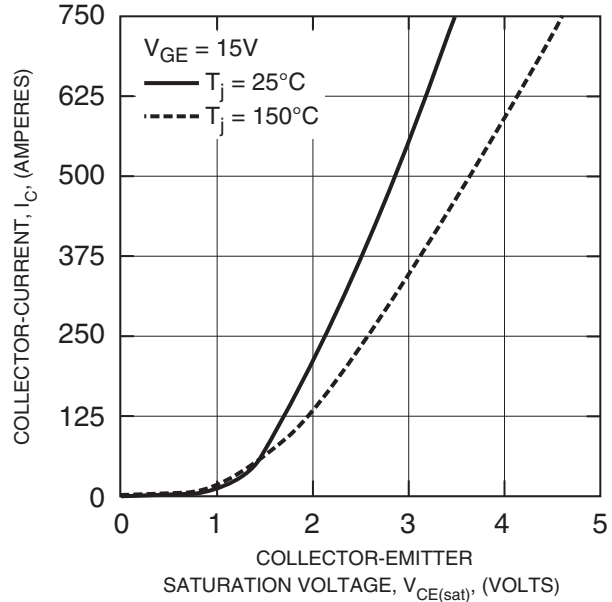

TRANSFER CHARACTERISTICS (TYPICAL)

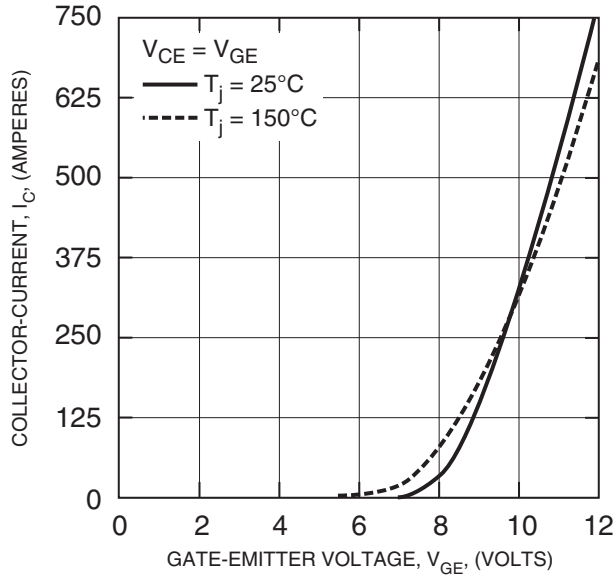

FREE-WHEEL DIODE FORWARD CHARACTERISTICS (TYPICAL)

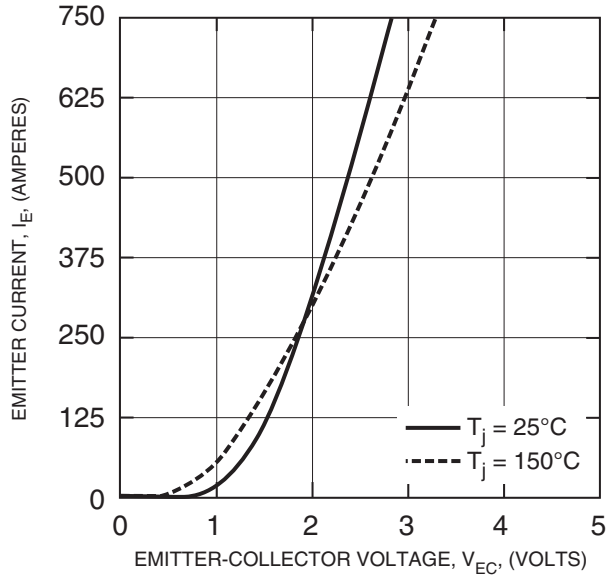

QID3350001
Dual IGBT HVIGBT Module
 500 Amperes/3300 Volts

CAPACITANCE VS. V_{CE}
 (TYPICAL)

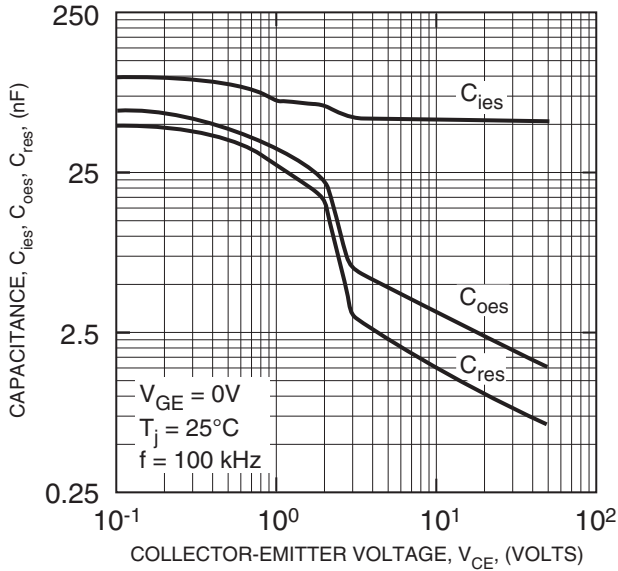

GATE CHARGE VS. V_{GE}

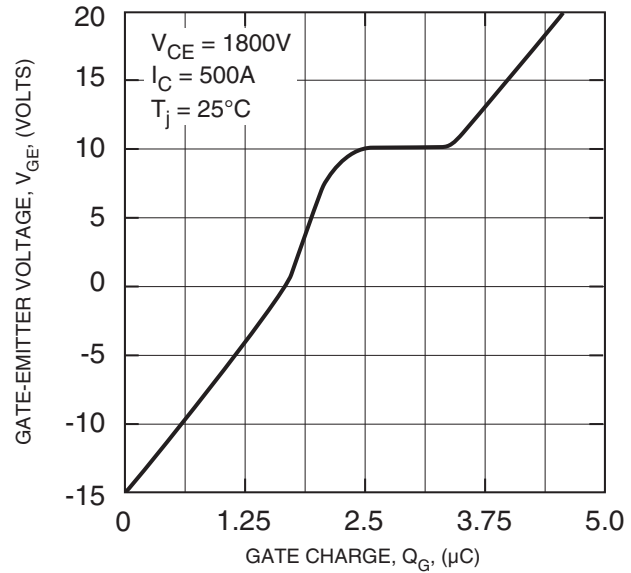

SWITCHING ENERGY CHARACTERISTICS (TYPICAL)

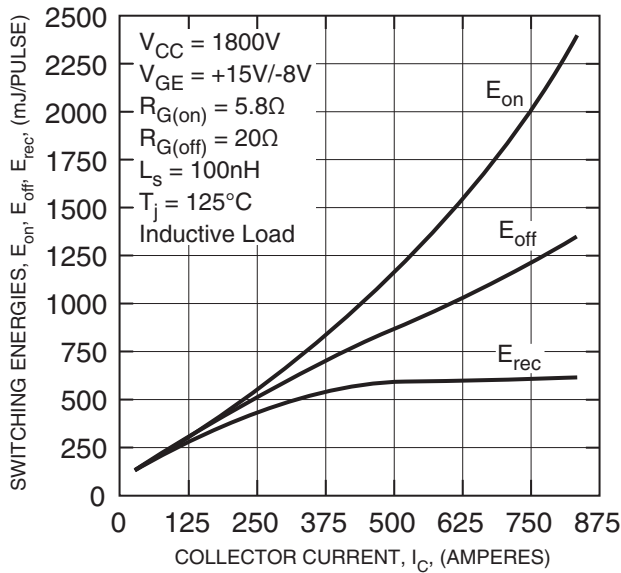

HALF-BRIDGE SWITCHING ENERGY CHARACTERISTICS (TYPICAL)

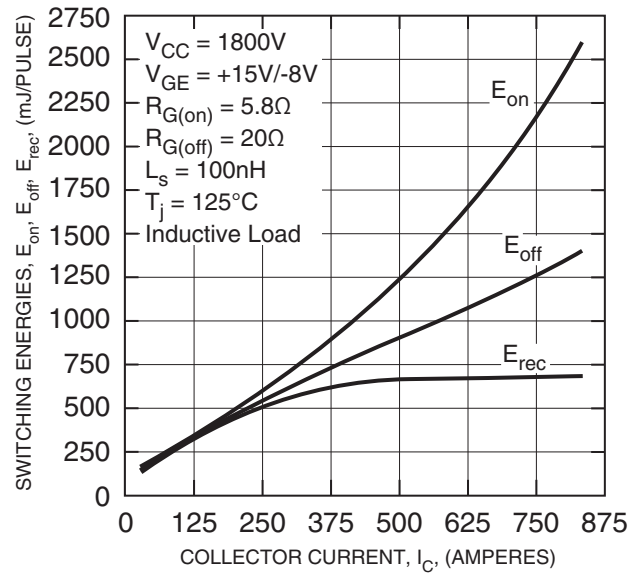

QID3350001
Dual IGBT HVIGBT Module
 500 Amperes/3300 Volts

REVERSE BIAS SAFE OPERATING AREA (TYPICAL)

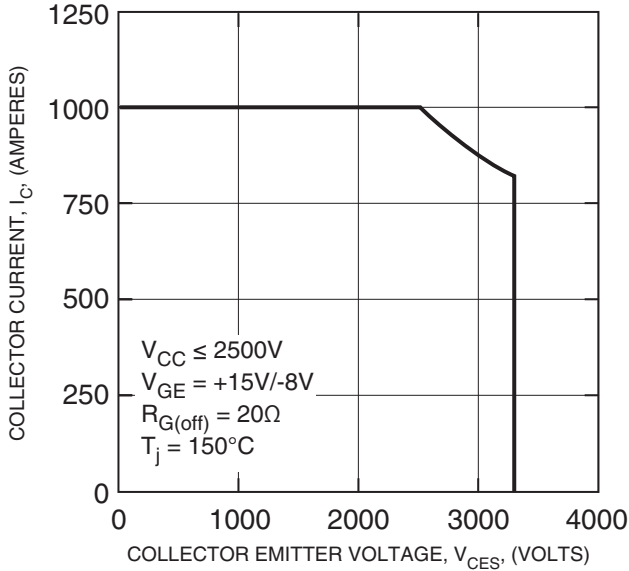

FREE-WHEEL DIODE REVERSE RECOVERY SAFE OPERATING AREA (TYPICAL)

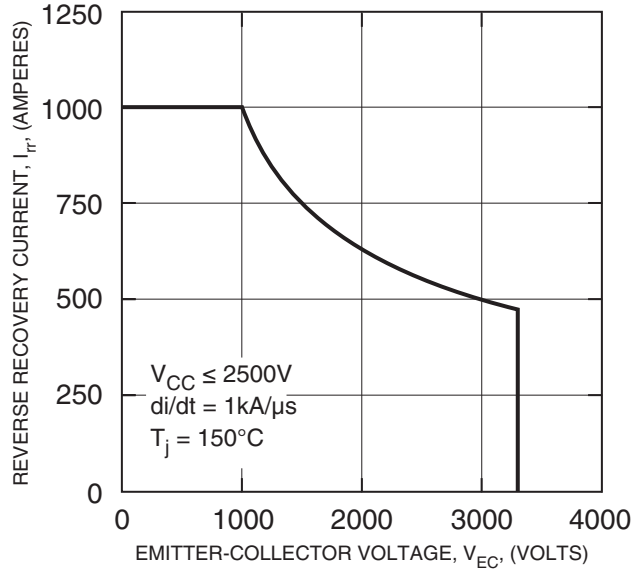

TRANSIENT THERMAL IMPEDANCE CHARACTERISTICS (IGBT & FWDi)

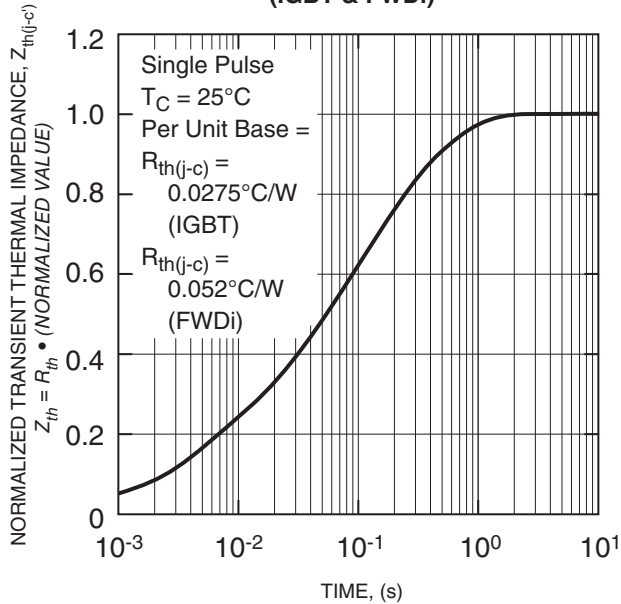

Information presented is based upon manufacturers testing and projected capabilities. This information is subject to change without notice. The manufacturer makes no claim as to the suitability of use, reliability, capability, or future availability of this product.