

General Description

The QM3016U is the highest performance trench N-ch MOSFETs with extreme high cell density, which provide excellent RDSON and gate charge for most of the synchronous buck converter applications.

The QM3016U meet the RoHS and Green Product requirement 100% EAS guaranteed with full function reliability approved.

Features

- Advanced high cell density Trench technology
- Super Low Gate Charge
- Excellent CdV/dt effect decline
- 100% EAS Guaranteed
- Green Device Available

Absolute Maximum Ratings

Symbol	Parameter	Rating	Units
V_{DS}	Drain-Source Voltage	30	V
V_{GS}	Gate-Source Voltage	± 20	V
$I_D@T_C=25^\circ C$	Continuous Drain Current, $V_{GS} @ 10V^1$	93	A
$I_D@T_C=100^\circ C$	Continuous Drain Current, $V_{GS} @ 10V^1$	59	A
I_{DM}	Pulsed Drain Current ²	190	A
EAS	Single Pulse Avalanche Energy ³	317	mJ
I_{AS}	Avalanche Current	53.8	A
$P_D@T_C=25^\circ C$	Total Power Dissipation ⁴	62.5	W
T_{STG}	Storage Temperature Range	-55 to 175	$^\circ C$
T_J	Operating Junction Temperature Range	-55 to 175	$^\circ C$

Thermal Data

Symbol	Parameter	Typ.	Max.	Unit
$R_{\theta JA}$	Thermal Resistance Junction-Ambient ¹	---	62	$^\circ C/W$
$R_{\theta JC}$	Thermal Resistance Junction-Case ¹	---	2.4	$^\circ C/W$

Product Summary



BVDSS	RDSON	ID
30V	4m Ω	93A

Applications

- High Frequency Point-of-Load Synchronous Buck Converter for MB/NB/UMPC/VGA
- Networking DC-DC Power System
- Load Switch

TO251 Pin Configuration

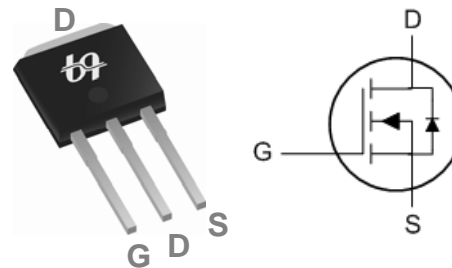

Electrical Characteristics ($T_J=25^\circ\text{C}$, unless otherwise noted)

Symbol	Parameter	Conditions	Min.	Typ.	Max.	Unit
BV_{DSS}	Drain-Source Breakdown Voltage	$V_{GS}=0V, I_D=250\mu A$	30	---	---	V
$\Delta BV_{DSS}/\Delta T_J$	BVDSS Temperature Coefficient	Reference to 25°C , $I_D=1\text{mA}$	---	0.0213	---	V/ $^\circ\text{C}$
$R_{DS(ON)}$	Static Drain-Source On-Resistance ²	$V_{GS}=10V, I_D=30A$	---	3.4	4	m Ω
		$V_{GS}=4.5V, I_D=15A$	---	5.2	6	
$V_{GS(th)}$	Gate Threshold Voltage	$V_{GS}=V_{DS}, I_D=250\mu A$	1.0	1.5	2.5	V
$\Delta V_{GS(th)}$	$V_{GS(th)}$ Temperature Coefficient		---	-5.73	---	mV/ $^\circ\text{C}$
I_{DSS}	Drain-Source Leakage Current	$V_{DS}=24V, V_{GS}=0V, T_J=25^\circ\text{C}$	---	---	1	μA
		$V_{DS}=24V, V_{GS}=0V, T_J=55^\circ\text{C}$	---	---	5	
I_{GSS}	Gate-Source Leakage Current	$V_{GS}=\pm 20V, V_{DS}=0V$	---	---	± 100	nA
g_{fs}	Forward Transconductance	$V_{DS}=5V, I_D=30A$	---	26.5	---	S
R_g	Gate Resistance	$V_{DS}=0V, V_{GS}=0V, f=1\text{MHz}$	---	1.4	2.8	Ω
Q_g	Total Gate Charge (4.5V)	$V_{DS}=20V, V_{GS}=4.5V, I_D=12A$	---	31.6		nC
Q_{gs}	Gate-Source Charge		---	6.07		
Q_{gd}	Gate-Drain Charge		---	13.8		
$T_{d(on)}$	Turn-On Delay Time	$V_{DD}=12V, V_{GS}=10V, R_G=3.3\Omega, I_D=5A$	---	11.2		ns
T_r	Rise Time		---	49		
$T_{d(off)}$	Turn-Off Delay Time		---	35		
T_f	Fall Time		---	7.8		
C_{iss}	Input Capacitance	$V_{DS}=15V, V_{GS}=0V, f=1\text{MHz}$	---	3075		pF
C_{oss}	Output Capacitance		---	400		
C_{riss}	Reverse Transfer Capacitance		---	315		

Guaranteed Avalanche Characteristics

Symbol	Parameter	Conditions	Min.	Typ.	Max.	Unit
EAS	Single Pulse Avalanche Energy ⁵	$V_{DD}=25V, L=0.1\text{mH}, I_{AS}=30A$	98	---	---	mJ

Diode Characteristics

Symbol	Parameter	Conditions	Min.	Typ.	Max.	Unit
I_S	Continuous Source Current ^{1,6}	$V_G=V_D=0V, \text{Force Current}$	---	---	93	A
I_{SM}	Pulsed Source Current ^{2,6}		---	---	190	A
V_{SD}	Diode Forward Voltage ²	$V_{GS}=0V, I_S=1A, T_J=25^\circ\text{C}$	---	---	1	V

Note :

- The data tested by surface mounted on a 1 inch² FR-4 board with 20Z copper.
- The data tested by pulsed, pulse width $\leq 300\mu\text{s}$, duty cycle $\leq 2\%$
- The EAS data shows Max. rating. The test condition is $V_{DD}=25V, V_{GS}=10V, L=0.1\text{mH}, I_{AS}=53.8A$
- The power dissipation is limited by 175°C junction temperature
- The Min. value is 100% EAS tested guarantee.
- The data is theoretically the same as I_D and I_{DM} , in real applications, should be limited by total power dissipation.

Typical Characteristics

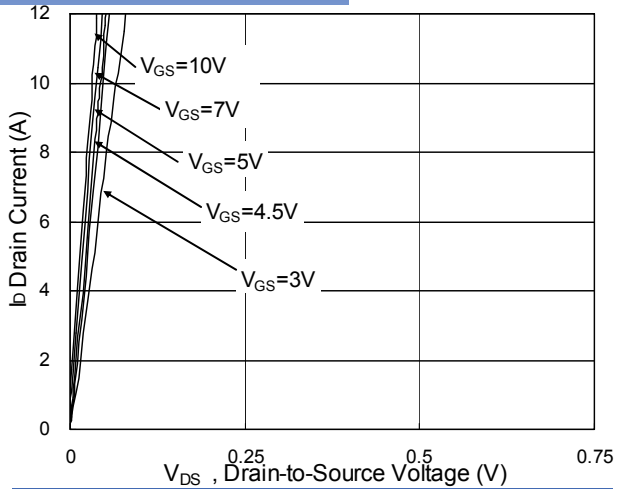

Fig.1 Typical Output Characteristics

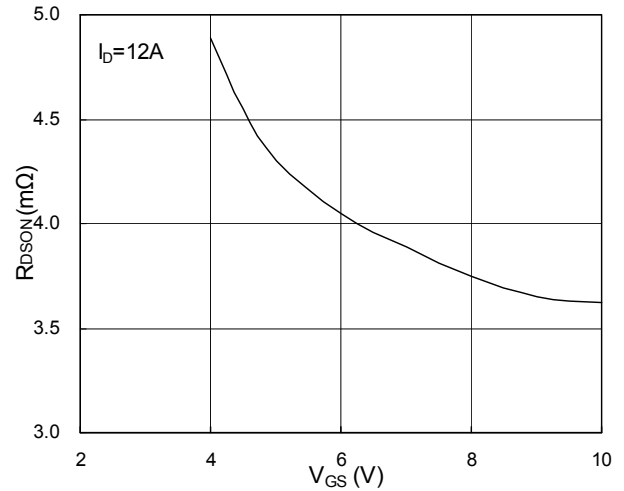

Fig.2 On-Resistance vs. G-S Voltage

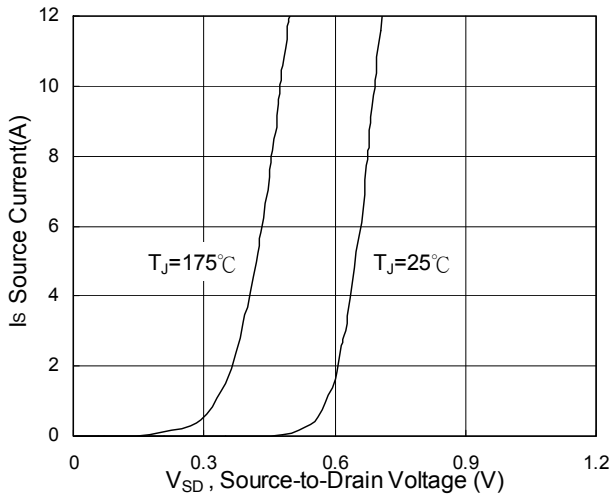

Fig.3 Forward Characteristics of Reverse

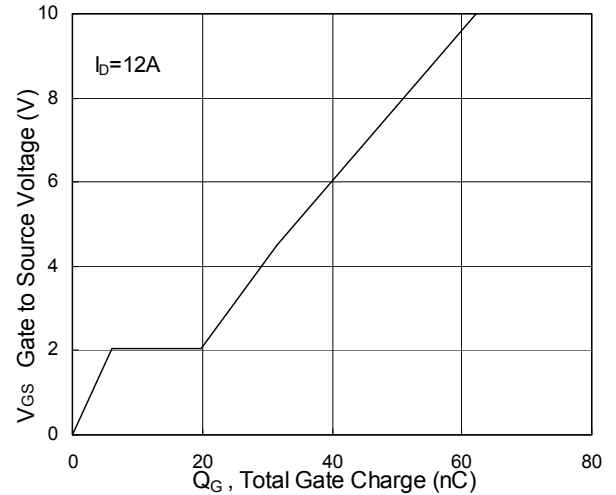

Fig.4 Gate-charge Characteristics

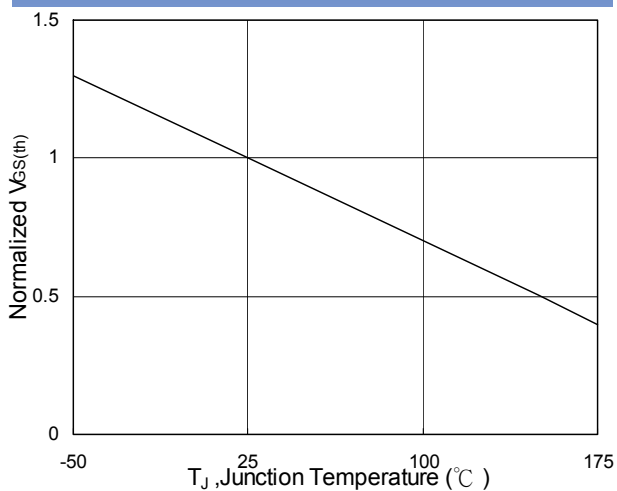

Fig.5 Normalized $V_{GS(th)}$ vs. T_J

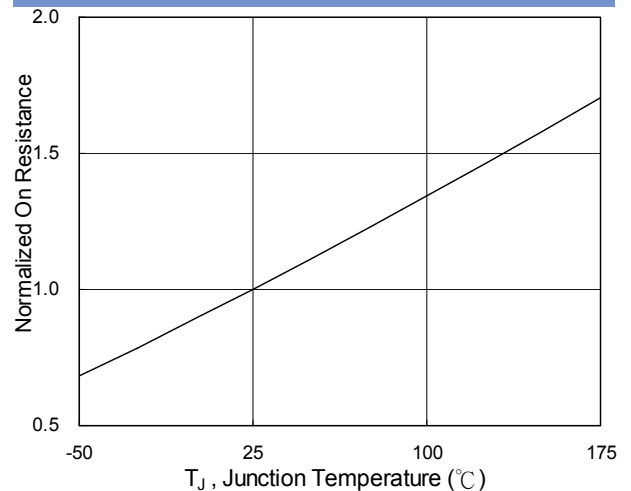

Fig.6 Normalized $R_{DS(on)}$ vs. T_J

N-Ch 30V Fast Switching MOSFETs

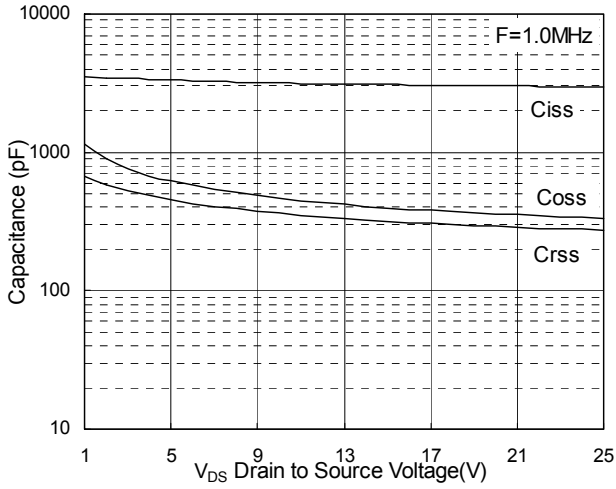

Fig.7 Capacitance

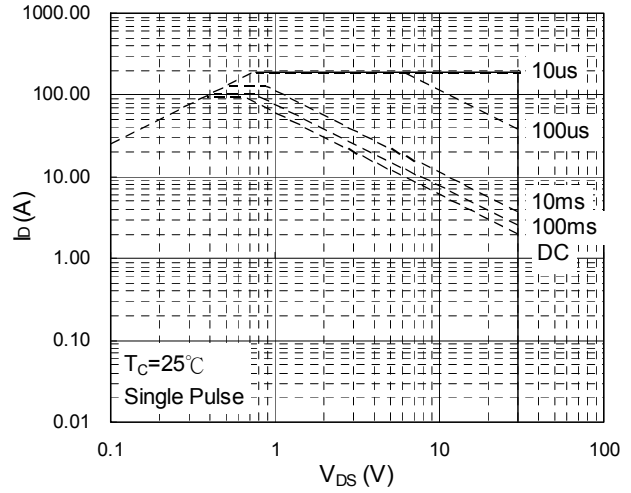

Fig.8 Safe Operating Area

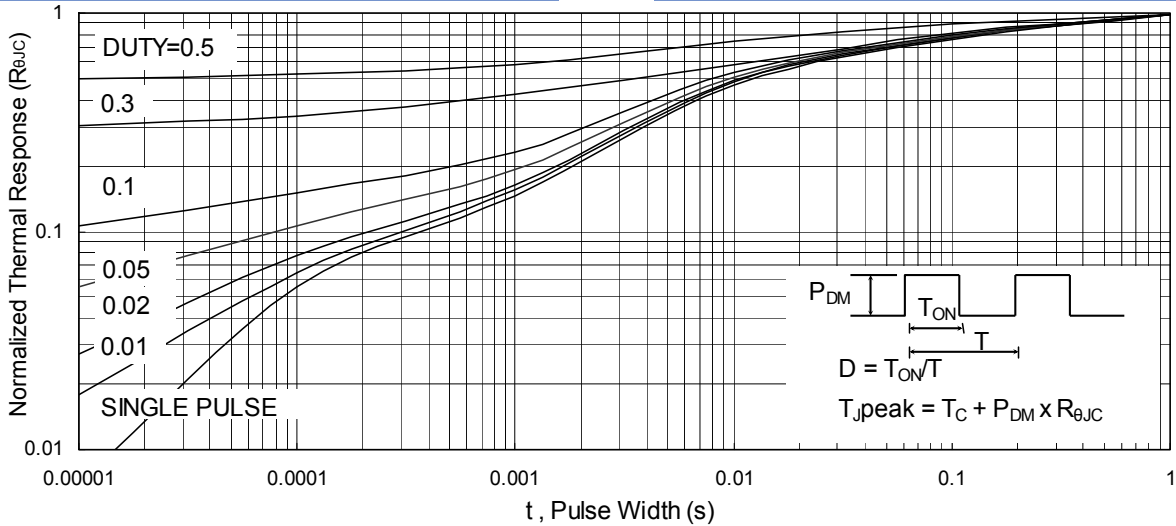

Fig.9 Normalized Maximum Transient Thermal Impedance

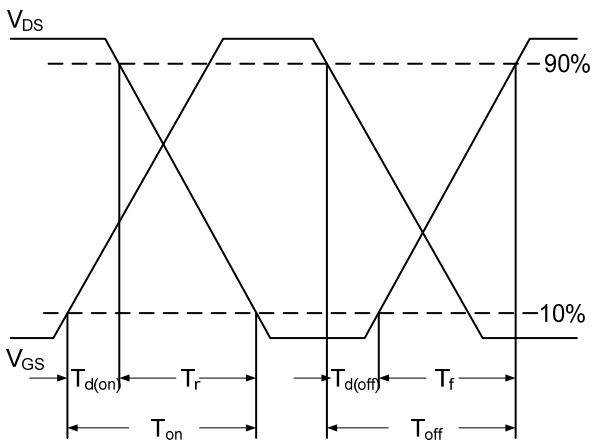

Fig.10 Switching Time Waveform

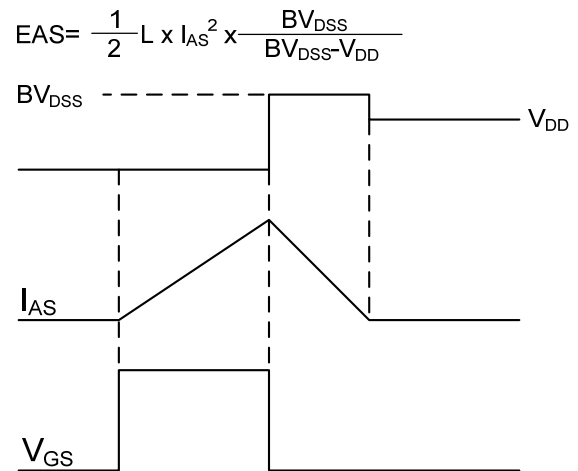

Fig.11 Unclamped Inductive Switching Wave