



### General Description

The QM3024M3 is the highest performance trench N-ch MOSFETs with extreme high cell density, which provide excellent R<sub>DS(on)</sub> and gate charge for most of the synchronous buck converter applications.

The QM3024M3 meet the RoHS and Green Product requirement, 100% EAS guaranteed with full function reliability approved.

### Features

- Advanced high cell density Trench technology
- Super Low Gate Charge
- Excellent CdV/dt effect decline
- 100% EAS Guaranteed
- Green Device Available

### Absolute Maximum Ratings

Symbol	Parameter	Rating		Units
		10s	Steady State	
V <sub>DS</sub>	Drain-Source Voltage	30		V
V <sub>GS</sub>	Gate-Source Voltage	±20		V
I <sub>D</sub> @T <sub>C</sub> =25°C	Continuous Drain Current, V <sub>GS</sub> @ 10V <sup>1</sup>	46		A
I <sub>D</sub> @T <sub>C</sub> =100°C	Continuous Drain Current, V <sub>GS</sub> @ 10V <sup>1</sup>	29		A
I <sub>D</sub> @T <sub>A</sub> =25°C	Continuous Drain Current, V <sub>GS</sub> @ 10V <sup>1</sup>	17.3	11	A
I <sub>D</sub> @T <sub>A</sub> =70°C	Continuous Drain Current, V <sub>GS</sub> @ 10V <sup>1</sup>	13.8	8.7	A
I <sub>DM</sub>	Pulsed Drain Current <sup>2</sup>	92		A
EAS	Single Pulse Avalanche Energy <sup>3</sup>	130		mJ
I <sub>AS</sub>	Avalanche Current	34		A
P <sub>D</sub> @T <sub>C</sub> =25°C	Total Power Dissipation <sup>4</sup>	29		W
P <sub>D</sub> @T <sub>A</sub> =25°C	Total Power Dissipation <sup>4</sup>	4.2	1.67	W
T <sub>STG</sub>	Storage Temperature Range	-55 to 150		°C
T <sub>J</sub>	Operating Junction Temperature Range	-55 to 150		°C

### Product Summary

BVDSS	R <sub>DS(on)</sub>	I <sub>D</sub>
30V	9 mΩ	46A

### Applications

- High Frequency Point-of-Load Synchronous Buck Converter for MB/NB/UMPC/VGA
- Networking DC-DC Power System
- Load Switch

### PRPAK3X3 Pin Configuration

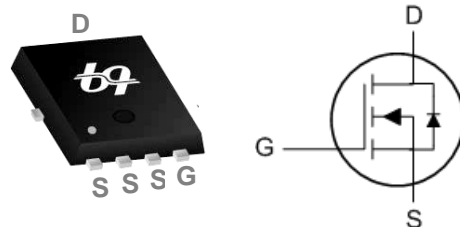

Symbol	Parameter	Typ.	Max.	Unit
R <sub>θJA</sub>	Thermal Resistance Junction-Ambient <sup>1</sup>	---	75	°C/W
R <sub>θJA</sub>	Thermal Resistance Junction-Ambient <sup>1</sup> (t ≤ 10s)	---	30	°C/W
R <sub>θJC</sub>	Thermal Resistance Junction-Case <sup>1</sup>	---	4.32	°C/W

### Electrical Characteristics ( $T_J=25^\circ\text{C}$ , unless otherwise noted)

Symbol	Parameter	Conditions	Min.	Typ.	Max.	Unit
$BV_{DSS}$	Drain-Source Breakdown Voltage	$V_{GS}=0V, I_D=250\mu A$	30	35	---	V
$\Delta BV_{DSS}/\Delta T_J$	$BV_{DSS}$ Temperature Coefficient	Reference to $25^\circ\text{C}$ , $I_D=1\text{mA}$	---	0.024	---	V/ $^\circ\text{C}$
$R_{DS(ON)}$	Static Drain-Source On-Resistance <sup>2</sup>	$V_{GS}=10V, I_D=30A$	---	7.2	9	m $\Omega$
		$V_{GS}=4.5V, I_D=15A$	---	10.5	13.5	
$V_{GS(th)}$	Gate Threshold Voltage	$V_{GS}=V_{DS}, I_D=250\mu A$	1.2	1.5	2.5	V
$\Delta V_{GS(th)}$	$V_{GS(th)}$ Temperature Coefficient		---	-3.5	---	mV/ $^\circ\text{C}$
$I_{DSS}$	Drain-Source Leakage Current	$V_{DS}=24V, V_{GS}=0V, T_J=25^\circ\text{C}$	---	---	1	$\mu\text{A}$
		$V_{DS}=24V, V_{GS}=0V, T_J=55^\circ\text{C}$	---	---	5	
$I_{GSS}$	Gate-Source Leakage Current	$V_{GS}=\pm 20V, V_{DS}=0V$	---	---	$\pm 100$	nA
$g_{fs}$	Forward Transconductance	$V_{DS}=5V, I_D=30A$	---	38.2	---	S
$R_g$	Gate Resistance	$V_{DS}=0V, V_{GS}=0V, f=1\text{MHz}$	---	1.45	2.4	$\Omega$
$Q_g$	Total Gate Charge (4.5V)	$V_{DS}=15V, V_{GS}=4.5V, I_D=15A$	---	10.6	14.8	nC
$Q_{gs}$	Gate-Source Charge		---	4.2	5.9	
$Q_{gd}$	Gate-Drain Charge		---	4.0	5.6	
$T_{d(on)}$	Turn-On Delay Time	$V_{DD}=15V, V_{GS}=10V, R_G=3.3\Omega, I_D=15A$	---	6.4	12.8	ns
$T_r$	Rise Time		---	70.6	127	
$T_{d(off)}$	Turn-Off Delay Time		---	22.4	45	
$T_f$	Fall Time		---	8.0	16	
$C_{iss}$	Input Capacitance	$V_{DS}=15V, V_{GS}=0V, f=1\text{MHz}$	---	1127	1578	pF
$C_{oss}$	Output Capacitance		---	194	272	
$C_{riss}$	Reverse Transfer Capacitance		---	77	108	

### Guaranteed Avalanche Characteristics

Symbol	Parameter	Conditions	Min.	Typ.	Max.	Unit
EAS	Single Pulse Avalanche Energy <sup>5</sup>	$V_{DD}=25V, L=0.1\text{mH}, I_{AS}=20A$	45	---	---	mJ

### Diode Characteristics

Symbol	Parameter	Conditions	Min.	Typ.	Max.	Unit
$I_S$	Continuous Source Current <sup>1,6</sup>	$V_G=V_D=0V$ , Force Current	---	---	46	A
$I_{SM}$	Pulsed Source Current <sup>2,6</sup>		---	---	92	A
$V_{SD}$	Diode Forward Voltage <sup>2</sup>	$V_{GS}=0V, I_S=1A, T_J=25^\circ\text{C}$	---	---	1	V
$t_{rr}$	Reverse Recovery Time	$I_F=30A, di/dt=100A/\mu s, T_J=25^\circ\text{C}$	---	12	---	nS
$Q_{rr}$	Reverse Recovery Charge		---	3.7	---	nC

Note :

- The data tested by surface mounted on a 1 inch<sup>2</sup> FR-4 board with 20Z copper.
- The data tested by pulsed, pulse width  $\leq 300\mu s$ , duty cycle  $\leq 2\%$
- The EAS data shows Max. rating. The test condition is  $V_{DD}=25V, V_{GS}=10V, L=0.1\text{mH}, I_{AS}=34A$
- The power dissipation is limited by  $150^\circ\text{C}$  junction temperature
- The Min. value is 100% EAS tested guarantee.
- The data is theoretically the same as  $I_D$  and  $I_{DM}$ , in real applications, should be limited by total power dissipation.

### Typical Characteristics

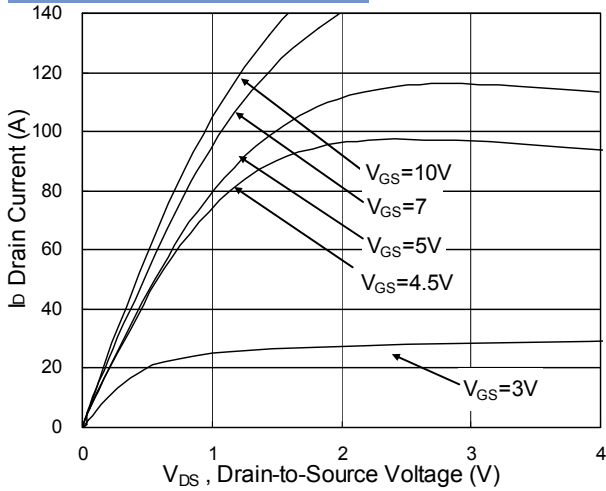

Fig.1 Typical Output Characteristics

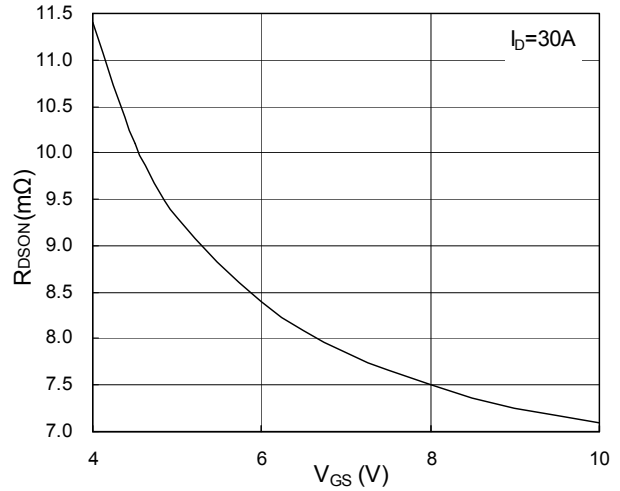

Fig.2 On-Resistance vs. Gate-Source

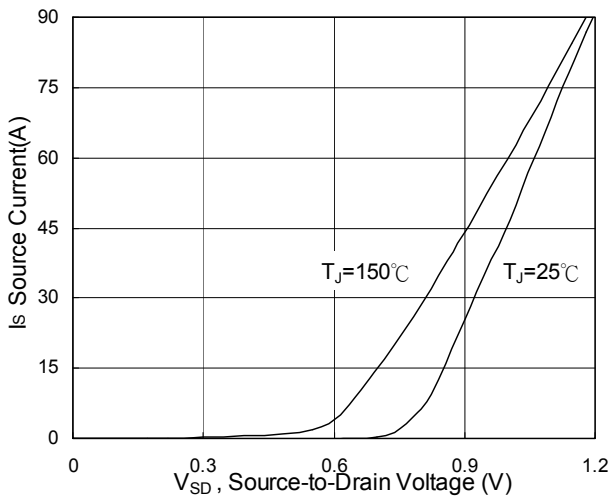

Fig.3 Forward Characteristics of Reverse

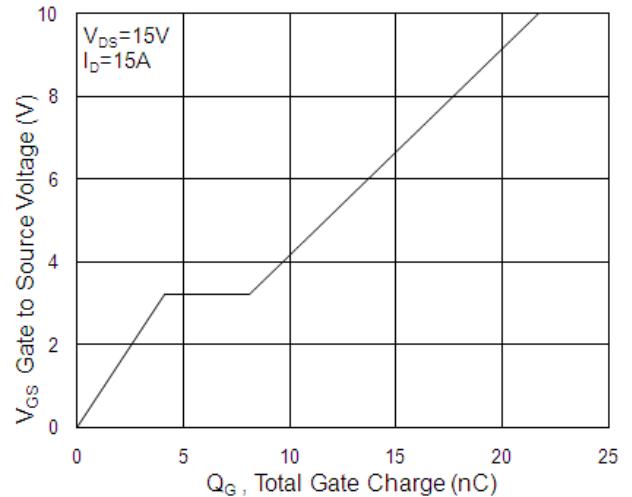

Fig.4 Gate-Charge Characteristics

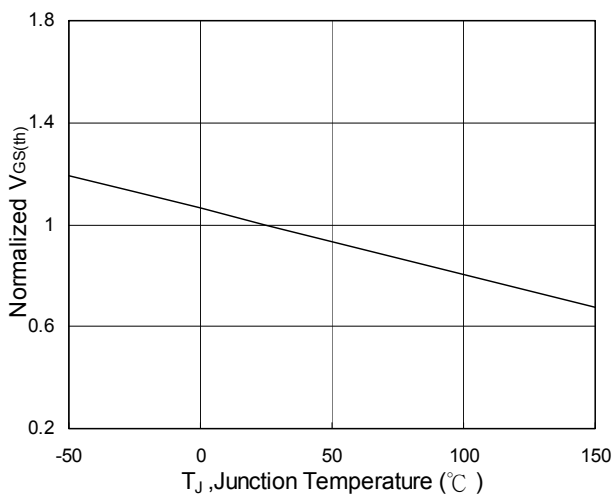

Fig.5 Normalized V<sub>GS(th)</sub> vs. T<sub>J</sub>

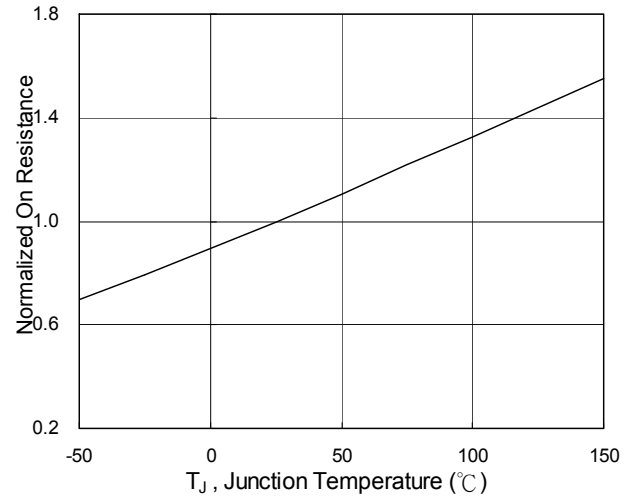

Fig.6 Normalized R<sub>DS(on)</sub> vs. T<sub>J</sub>

## N-Ch 30V Fast Switching MOSFETs

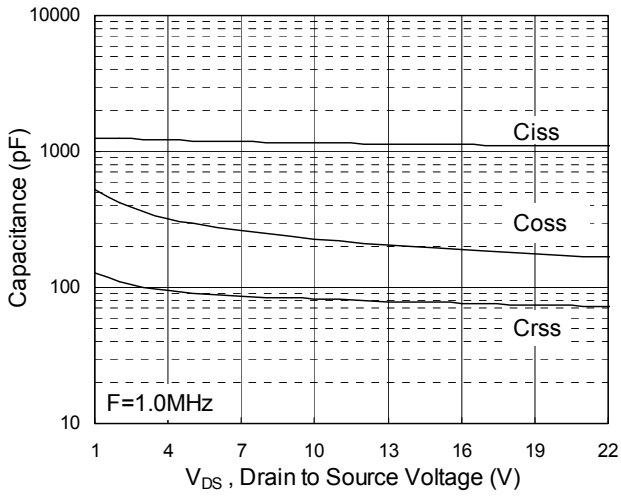

Fig.7 Capacitance

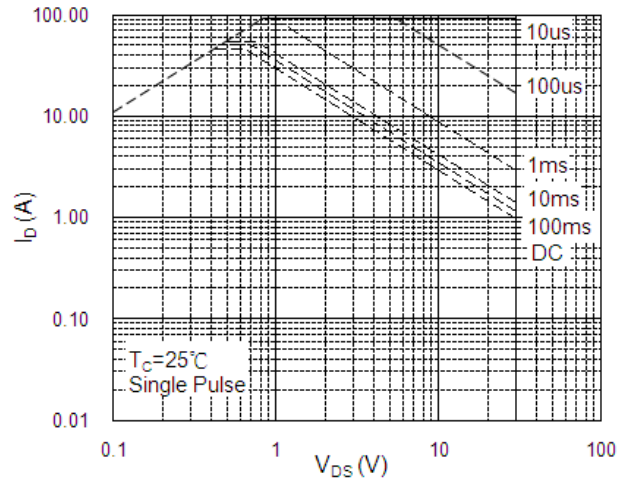

Fig.8 Safe Operating Area

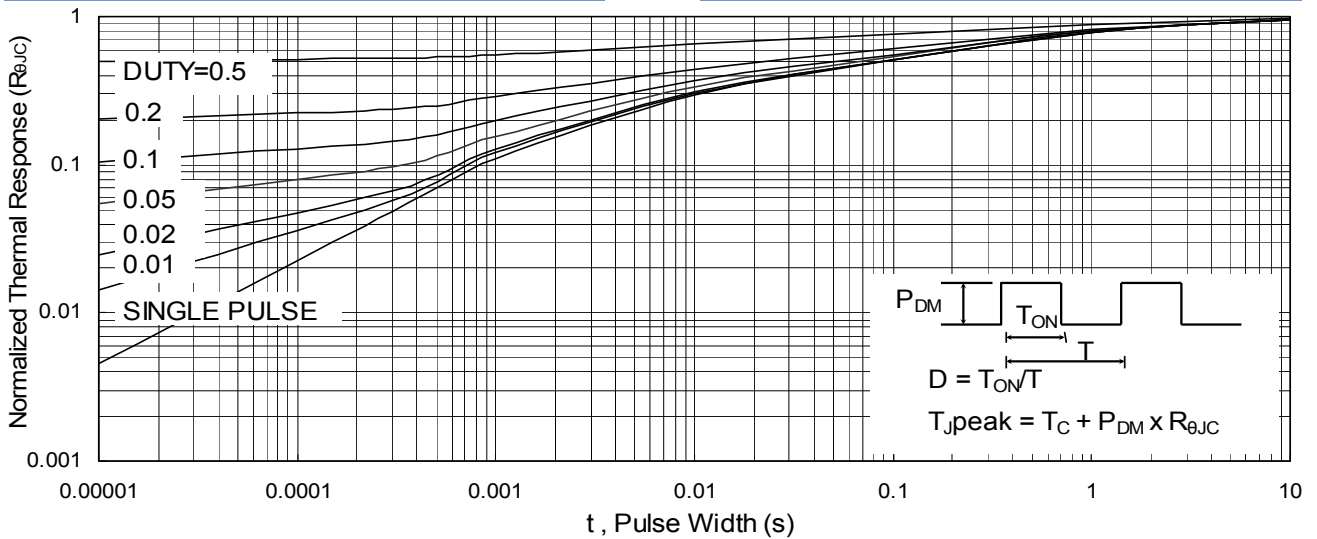

Fig.9 Normalized Maximum Transient Thermal Impedance

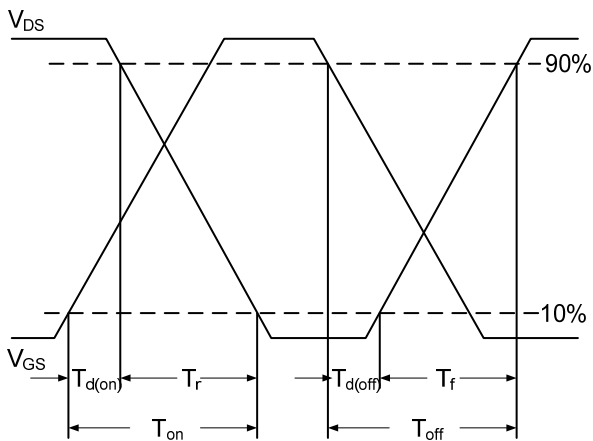

Fig.10 Switching Time Waveform

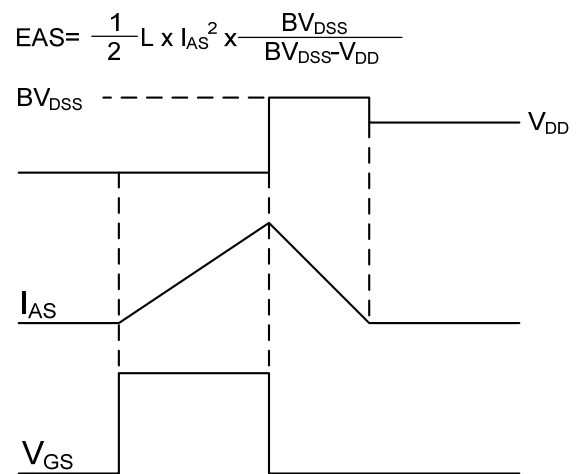

Fig.11 Unclamped Inductive Switching Waveform

$$EAS = \frac{1}{2} L \times I_{AS}^2 \times \frac{BV_{DSS}}{BV_{DSS} - V_{DD}}$$