

QM400HA-H

HIGH POWER SWITCHING USE
INSULATED TYPE

QM400HA-H



- **IC** Collector current **400A**
- **VCEX** Collector-emitter voltage **600V**
- **hFE** DC current gain **750**
- **Insulated Type**
- **UL Recognized**

Yellow Card No. E80276 (N)
File No. E80271

APPLICATION

AC motor controllers, UPS, DC motor controllers, NC equipment

OUTLINE DRAWING & CIRCUIT DIAGRAM

Dimensions in mm

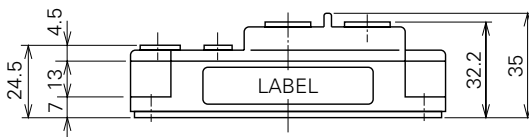
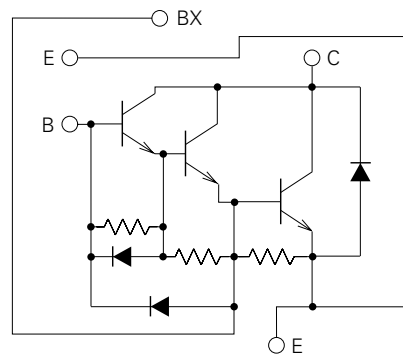
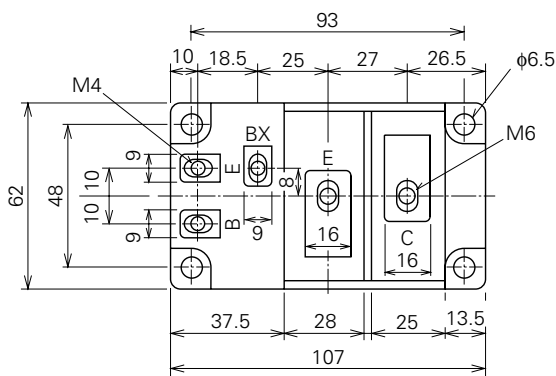

QM400HA-H

**HIGH POWER SWITCHING USE
INSULATED TYPE**

ABSOLUTE MAXIMUM RATINGS (T_j=25°C, unless otherwise noted)

Symbol	Parameter	Conditions	Ratings	Unit
V _{CEX} (SUS)	Collector-emitter voltage	I _C =1A, V _{EB} =2V	600	V
V _{CEX}	Collector-emitter voltage	V _{EB} =2V	600	V
V _{CBO}	Collector-base voltage	Emitter open	600	V
V _{EBO}	Emitter-base voltage	Collector open	7	V
I _C	Collector current	DC	400	A
-I _C	Collector reverse current	DC (forward diode current)	400	A
P _C	Collector dissipation	T _C =25°C	1500	W
I _B	Base current	DC	10	A
-I _{CSM}	Surge collector reverse current (forward diode current)	Peak value of one cycle of 60Hz (half wave)	4000	A
T _j	Junction temperature		-40~+150	°C
T _{stg}	Storage temperature		-40~+125	°C
V _{iso}	Isolation voltage	Charged part to case, AC for 1 minute	2500	V
—	Mounting torque	Main terminal screw M6	1.96~2.94	N·m
			20~30	kg·cm
		Mounting screw M6	1.96~2.94	N·m
			20~30	kg·cm
		B(E) terminal screw M4	0.98~1.47	N·m
		10~15	kg·cm	
		BX terminal screw M4	0.98~1.47	N·m
			10~15	kg·cm
—	Weight	Typical value	640	g

ELECTRICAL CHARACTERISTICS (T_j=25°C, unless otherwise noted)

Symbol	Parameter	Test conditions	Limits			Unit
			Min.	Typ.	Max.	
I _C EX	Collector cutoff current	V _{CE} =600V, V _{EB} =2V	—	—	5.0	mA
I _C BO	Collector cutoff current	V _{CB} =600V, Emitter open	—	—	5.0	mA
I _E BO	Emitter cutoff current	V _{EB} =7V	—	—	400	mA
V _{CE} (sat)	Collector-emitter saturation voltage	I _C =400A, I _B =0.53A	—	—	2.5	V
V _{BE} (sat)	Base-emitter saturation voltage		—	—	3.5	V
-V _{CEO}	Collector-emitter reverse voltage	-I _C =400A (diode forward voltage)	—	—	1.8	V
h _{FE}	DC current gain	I _C =400A, V _{CE} =2.5V	750	—	—	—
t _{on}	Switching time	V _{CC} =300V, I _C =400A, I _{B1} =0.8A, -I _{B2} =8A	—	—	3.0	μs
t _s			—	—	10	μs
t _f			—	—	35	μs
R _{th} (j-c) Ω			Thermal resistance (junction to case)	Transistor part	—	—
R _{th} (j-c) R	Diode part	—		—	0.25	°C/W
R _{th} (c-f)	Contact thermal resistance (case to fin)	Conductive grease applied	—	—	0.04	°C/W

QM400HA-H

HIGH POWER SWITCHING USE
INSULATED TYPE

PERFORMANCE CURVES

COMMON EMITTER OUTPUT CHARACTERISTICS (TYPICAL)

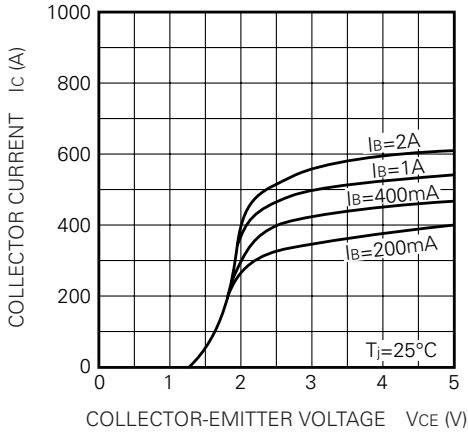

DC CURRENT GAIN VS. COLLECTOR CURRENT (TYPICAL)

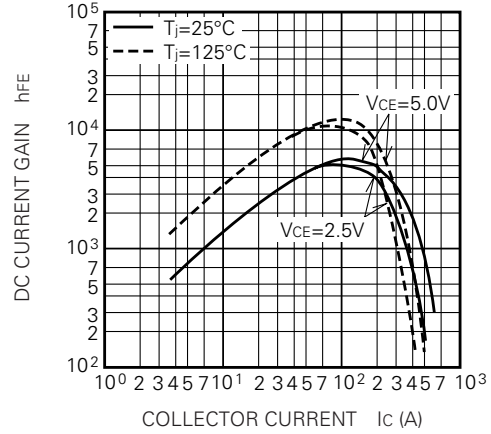

COMMON EMITTER INPUT CHARACTERISTIC (TYPICAL)

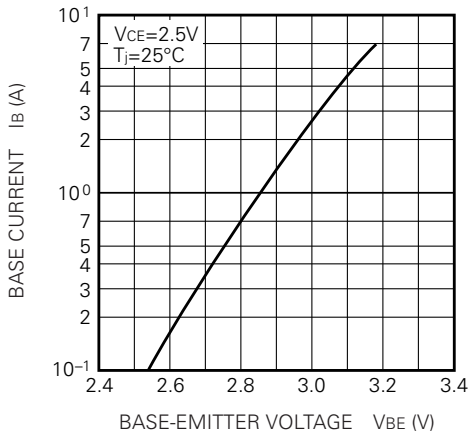

SATURATION VOLTAGE CHARACTERISTICS (TYPICAL)

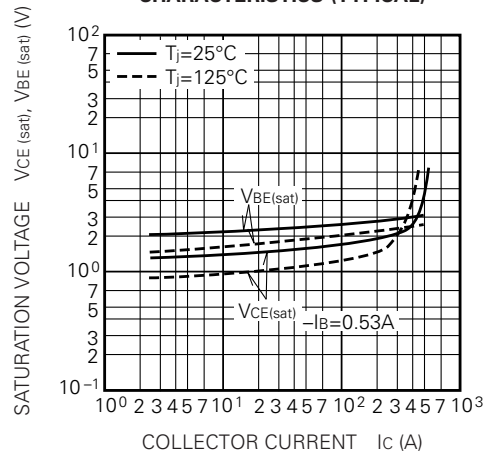

COLLECTOR-EMITTER SATURATION VOLTAGE (TYPICAL)

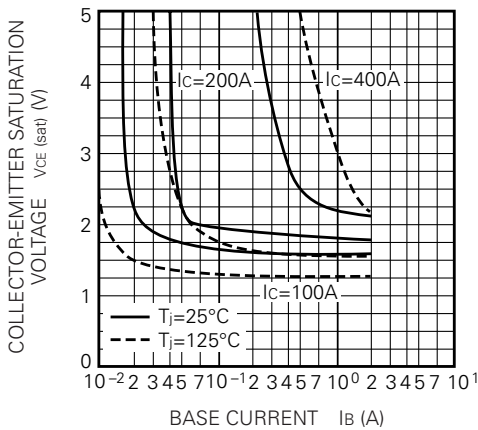

SWITCHING TIME VS. COLLECTOR CURRENT (TYPICAL)

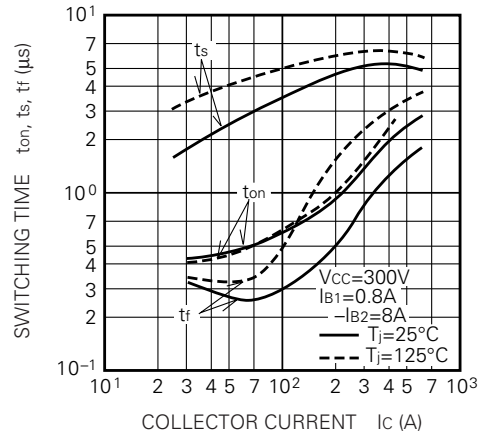

QM400HA-H

HIGH POWER SWITCHING USE
INSULATED TYPE

SWITCHING TIME VS. BASE CURRENT (TYPICAL)

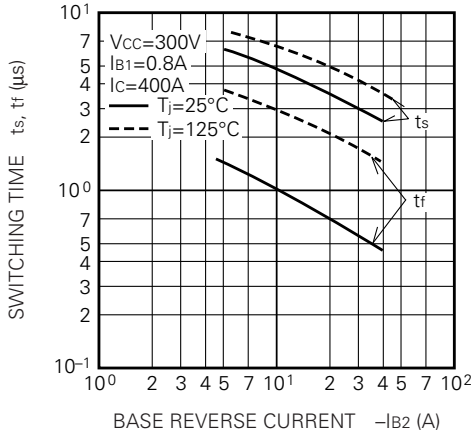

REVERSE BIAS SAFE OPERATING AREA

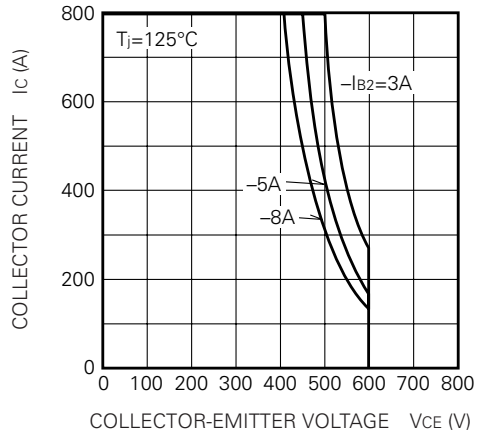

FORWARD BIAS SAFE OPERATING AREA

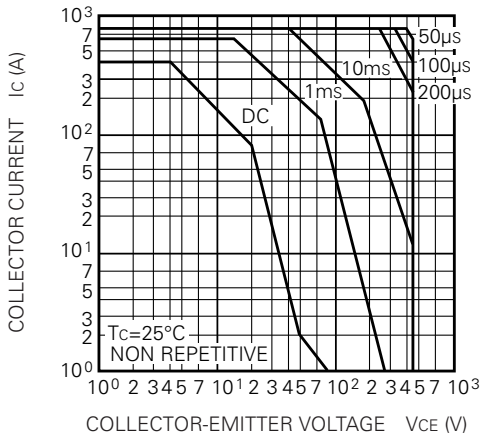

DERATING FACTOR OF F. B. S. O. A.

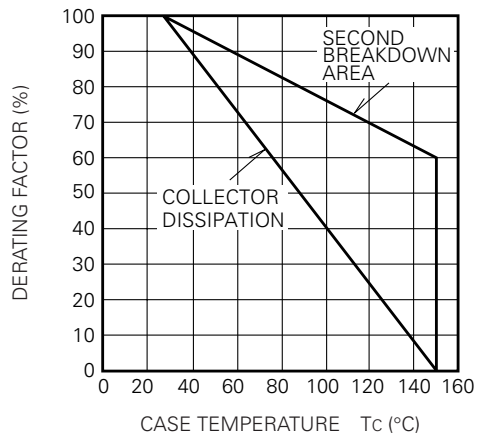

TRANSIENT THERMAL IMPEDANCE CHARACTERISTIC (TRANSISTOR)

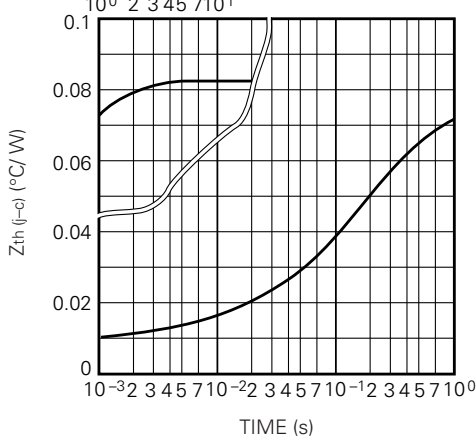

REVERSE COLLECTOR CURRENT VS. COLLECTOR-EMITTER REVERSE VOLTAGE (DIODE FORWARD CHARACTERISTICS) (TYPICAL)

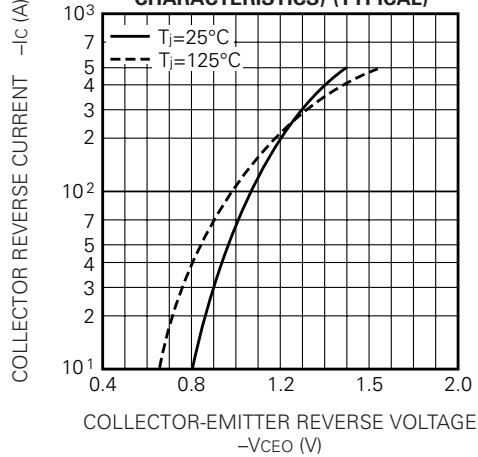

QM400HA-H

HIGH POWER SWITCHING USE
INSULATED TYPE

**RATED SURGE COLLECTOR REVERSE CURRENT
(DIODE FORWARD SURGE CURRENT)**

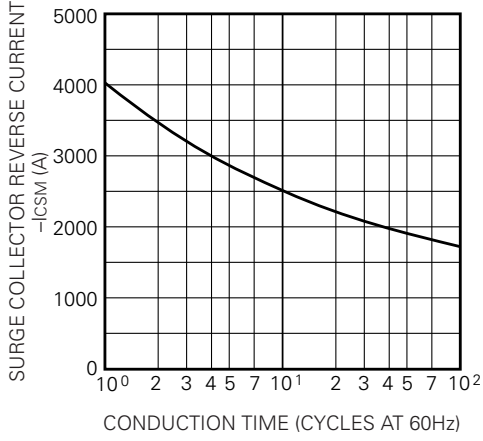

**TRANSIENT THERMAL IMPEDANCE
CHARACTERISTIC (DIODE)**

