

Product Overview

Qorvo's QPA1314T is a high power MMIC amplifier fabricated on Qorvo's production 0.15 um GaN on SiC process (QGaN15), mounted to a high thermal conductivity tab. The QPA1314T is targeted to the 13.75-14.5 GHz Satcom band. Linear power is 20 W with 25 dBc third order intermodulation distortion products. It provides 55 W of saturated output power with 22.5 dB of large signal gain while achieving 37% power-added efficiency. Operating frequency can extend to 12.75 – 15.35 GHz if desired.

To simplify system integration, the QPA1314T is fully matched to 50 ohms with DC grounded I/O ports for optimum ESD performance. Also, there are on-chip blocking capacitors following the DC grounds on the input and output ports.

The QPA1314T is ideal for supporting communications and radar applications in both commercial and military markets.

The QPA1314T is 100% DC and RF tested on-wafer to ensure compliance to electrical specifications.

Lead-free and RoHS compliant



Key Features

- Frequency Range: 13.75 – 14.5 GHz
- Extended Frequency Range: 12.75 – 15.35 GHz
- P_{SAT} ($P_{IN} = 25$ dBm): 47.5 dBm
- PAE ($P_{IN} = 25$ dBm): 37 %
- IM3 ($P_{OUT}/Tone = 40$ dBm): -25 dBc
- Small Signal Gain: 29 dB
- Bias: $V_D = +24$ V, $I_{D12} = 168$ mA, $I_{D3} = 512$ mA, $V_G = -2.3$ V +/- range.
- Dimensions: 4.98 x 6.91 x 0.38 mm

Performance is typical across frequency. Please reference electrical specification table and data plots for more details.

Functional Block Diagram

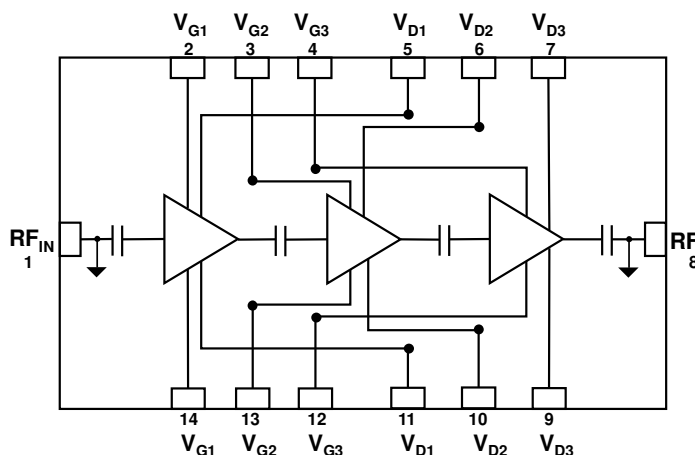

Applications

- Satellite Communications
- Datalinks

Ordering Information

Part No.	Description
QPA1314T	55 Watt GaN PA
QPA1314DEVB	Evaluation Board for QPA1314D

Absolute Maximum Ratings

Parameter	Value / Ra
Drain Voltage (V_D)	29.5 V
Gate Voltage Range (V_G)	-6 V to 0 V
Drain Current (I_{D1})	0.96 A
Drain Current (I_{D2})	1.96 A
Drain Current (I_{D3})	7.56 A
Drain Current (I_{D_TOTAL})	10.48 A
Gate Current (I_G)	See p. 25
Power Dissipation (P_{DISS}), 85 °C	130 W
Input Power (P_{IN}), 50 Ω , CW, $V_D = 24$ V, $I_{D12} = 228$ mA, $I_{D3} = 512$ mA, $T_{BASE} = 85$ °C	31 dBm
Input Power (P_{IN}), 3:1 VSWR, CW, $V_D = 24$ V, $I_{D12} = 228$ mA, $I_{D3} = 512$ mA, $T_{BASE} = 85$ °C	31 dBm
Mounting Temperature (30 seconds)	320 °C
Storage Temperature	-55 to +150

Operation of this device outside the parameter ranges given above may cause permanent damage. These are stress ratings only, and functional operation of the device at these conditions is not implied.

Electrical Specifications

Parameter	Conditions ⁽¹⁾ ⁽²⁾	Min	Typ.	Max	Units
Operational Frequency Range		13.75		14.5	GHz
Output Power at Saturation, P_{SAT}	$P_{IN} = 25$ dBm, Frequency = 13.75 – 14.5 GHz		47.5		dBm
	$P_{IN} = 25$ dBm, Frequency = 12.75 – 13.75 GHz ⁽³⁾		48		
	$P_{IN} = 25$ dBm, Frequency = 14.5 – 15.35 GHz ⁽³⁾		47		
Power Added Efficiency, PAE	$P_{IN} = 25$ dBm		37		%
Large Signal Gain	$P_{IN} = 25$ dBm		22.5		dB
3 RD Intermodulation Products, IM3	$P_{OUT}/Tone = 40$ dBm		-25		dBc
5 RD Intermodulation Products, IM5			-40		
Small Signal Gain, S21	$P_{IN} = -30$ dBm		29		dB
Input Return Loss, IRL			20		
Output Return Loss, ORL			7		
P_{SAT} Temperature Coefficient	$T_{DIFF} = 25$ °C to 85 °C; $P_{IN} = 25$ dBm		-0.04		dBm/°C
S21 Temperature Coefficient	$T_{DIFF} = 25$ °C to 85 °C		-0.10		dB/°C

Notes:

- Test conditions unless otherwise noted: CW, $V_D = 24$ V, $I_{D12} = 168$ mA, $I_{D3} = 512$ mA, $V_G = -2.3$ V +/- 0.6V typical, $T_{BASE} = +25$ °C, $Z_0 = 50$ Ω
- T_{BASE} is backside of QPA1314T
- Extended frequency range

Recommended Operating Conditions

Parameter	Min	Typ.	Max	Units
Drain Voltage (V_D)		24	24	V
Drain Current, Quiescent (I_{D12})		168		mA
Drain Current, Quiescent (I_{D3})		512		mA
Drain Current, RF (I_{D_Drive} Total)		See plot page 4,6,9,12		mA
Gate Voltage Typ. Range (V_G)		-1.7 to -2.9		V
Gate Current, RF (I_{G_Drive})		See plot page 5,6		mA
Input Power @ Saturation, (P_{IN})*		$T_{BASE} -40$ °C: 25		dBm
		$T_{BASE} +25$ °C: 25		
		$T_{BASE} +85$ °C: 29		
Operating Temp. Range (T_{BASE} *)	-40		+85	°C

* See plots page 7

T_{BASE} is backside of QPA1314T with AuSn solder

Electrical specifications are measured at specified test conditions. Specifications are not guaranteed over all recommended operating conditions.

Performance Plots – Large Signal

Test conditions, unless otherwise noted: CW, $V_D = 24\text{ V}$, $I_{D12} = 168\text{ mA}$, $I_{D3} = 512\text{ mA}$, $P_{IN} = 25\text{ dBm}$, $T_{BASE} = +25\text{ }^\circ\text{C}$ (T_{BASE} is backside of QPA1314T)

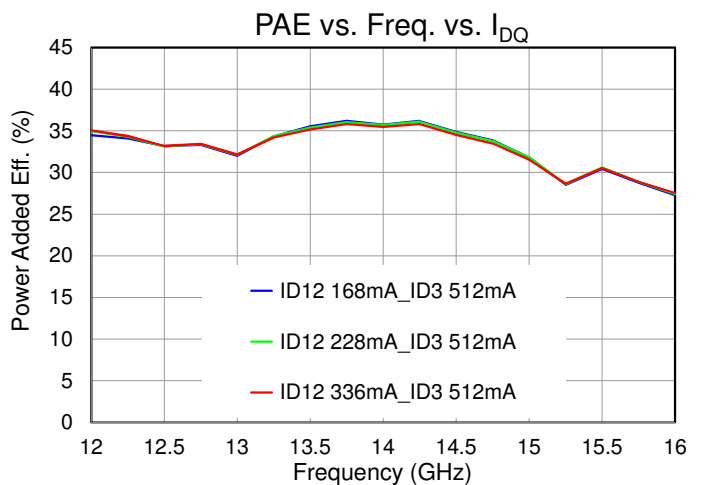
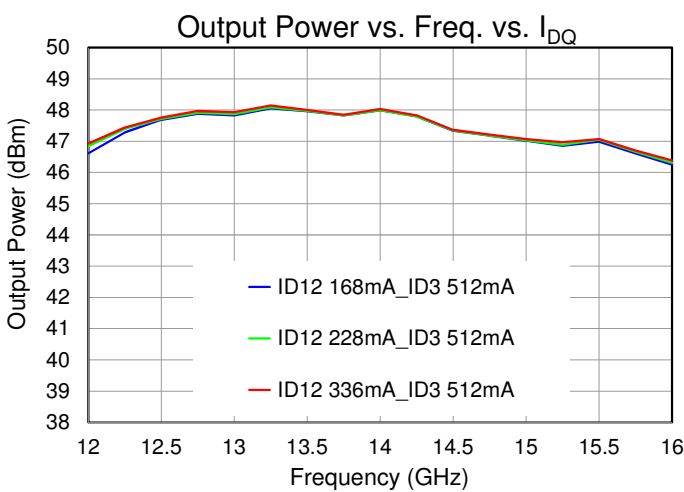
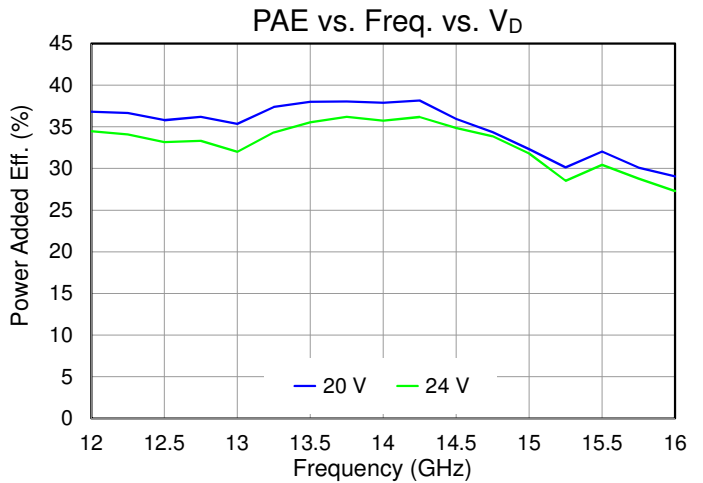
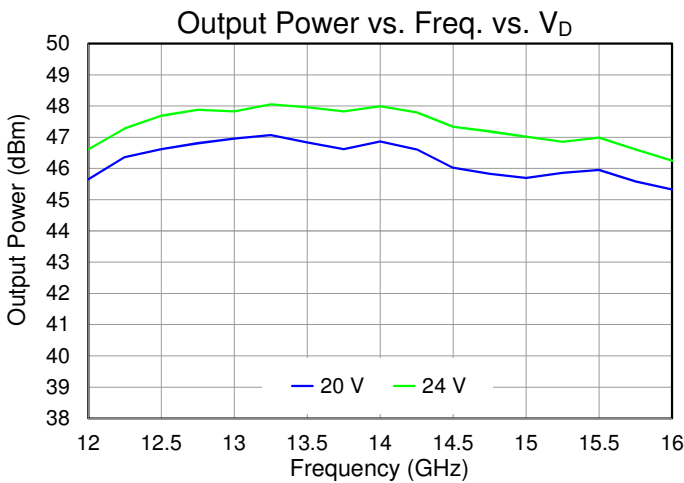
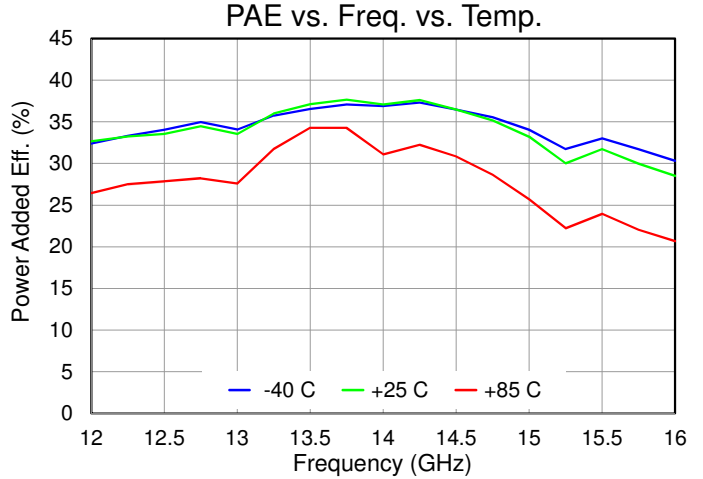
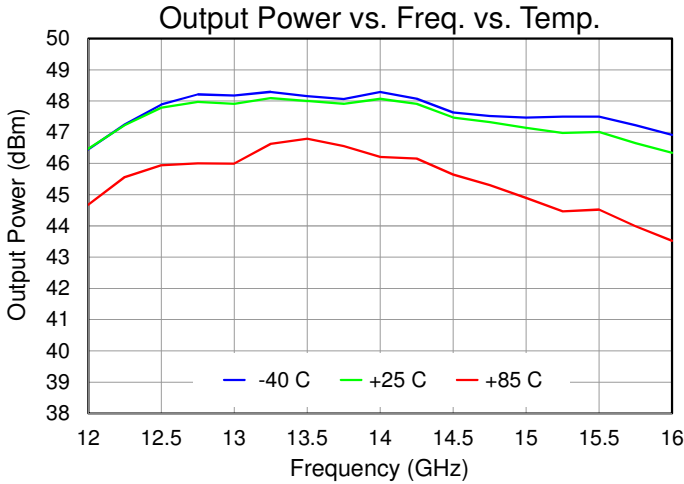

Performance Plots – Large Signal

Test conditions, unless otherwise noted: CW, $V_D = 24\text{ V}$, $I_{D12} = 168\text{ mA}$, $I_{D3} = 512\text{ mA}$, $P_{IN} = 25\text{ dBm}$, $T_{BASE} = +25\text{ }^\circ\text{C}$ (T_{BASE} is backside of QPA1314T)

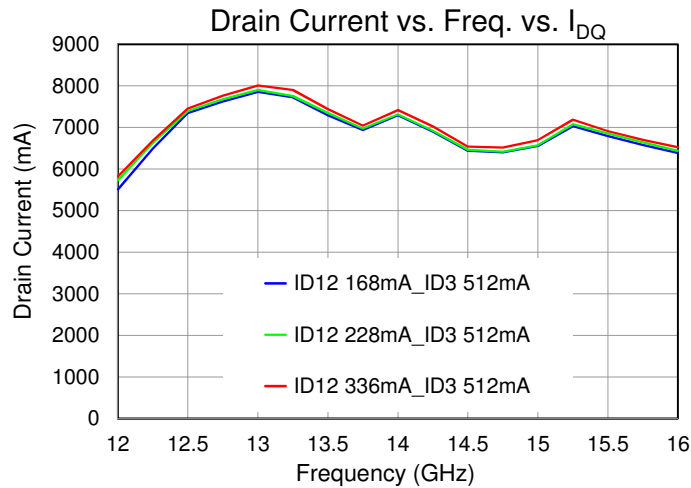
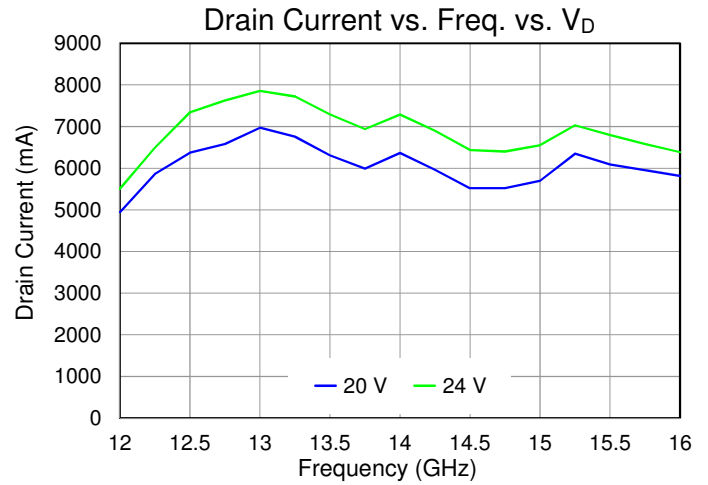
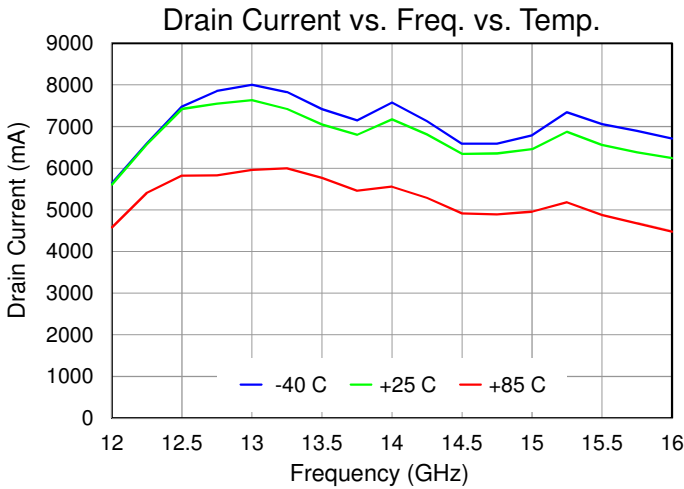

Performance Plots – Large Signal

Test conditions, unless otherwise noted: CW, $V_D = 24\text{ V}$, $I_{D12} = 168\text{ mA}$, $I_{D3} = 512\text{ mA}$, $P_{IN} = 25\text{ dBm}$, $T_{BASE} = +25\text{ }^\circ\text{C}$ (T_{BASE} is backside of QPA1314T)

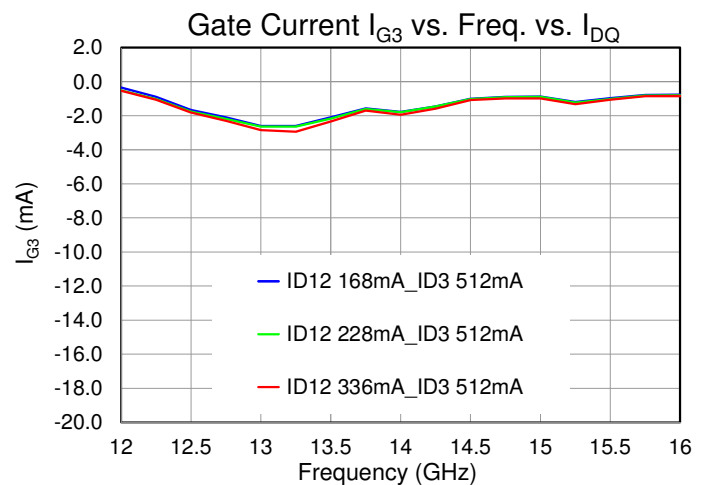
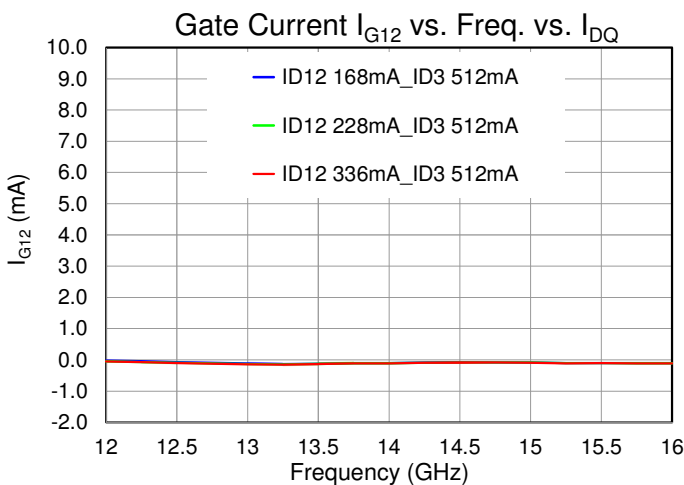
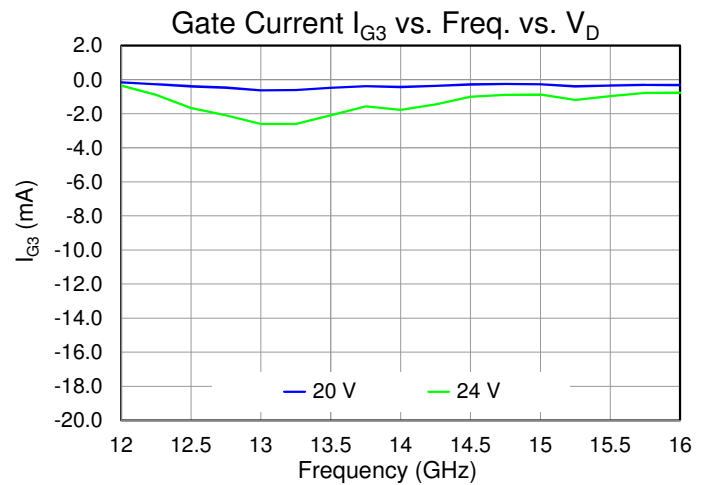
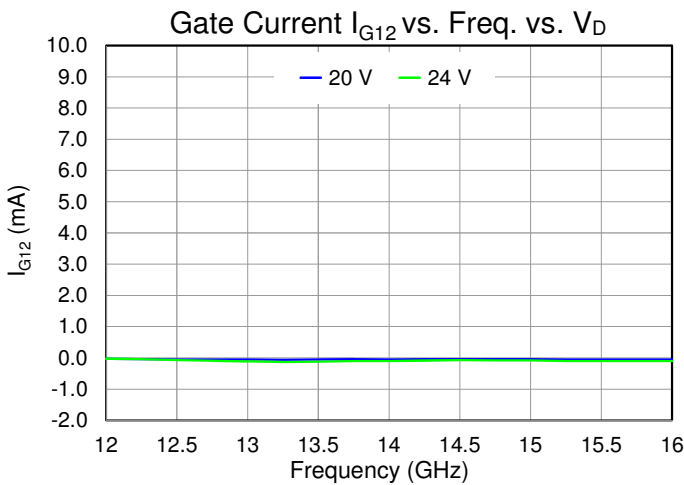
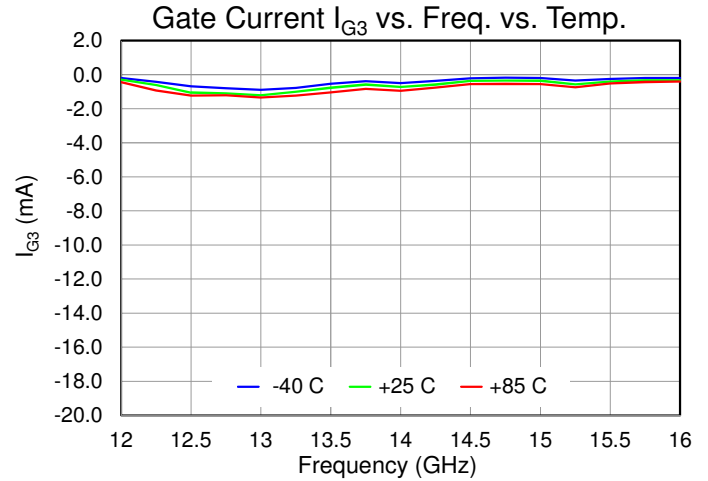
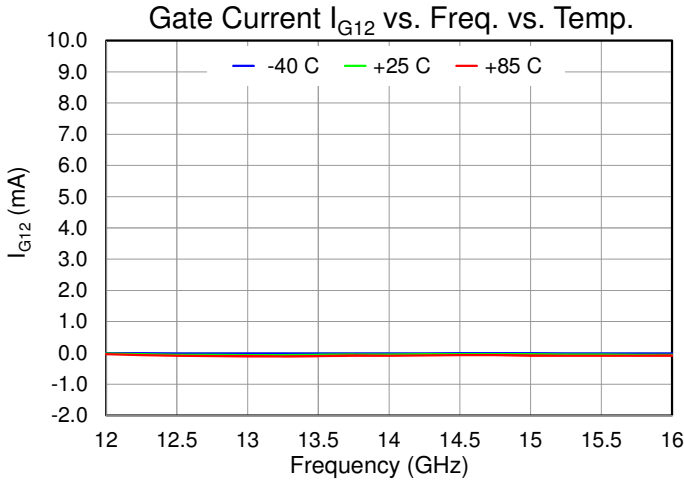

Performance Plots – Large Signal

Test conditions, unless otherwise noted: **CW**, $V_D = 24\text{ V}$, $I_{D12} = 168\text{ mA}$, $I_{D3} = 512\text{ mA}$, $P_{IN} = 25\text{ dBm}$, $T_{BASE} = +25\text{ }^\circ\text{C}$ (T_{BASE} is backside of QPA1314T)

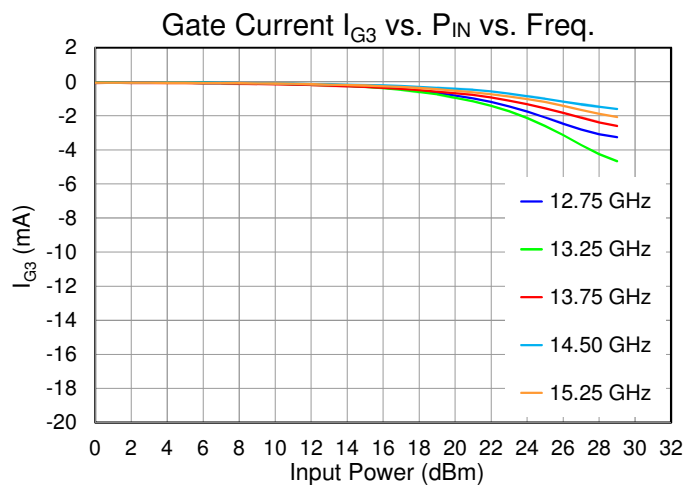
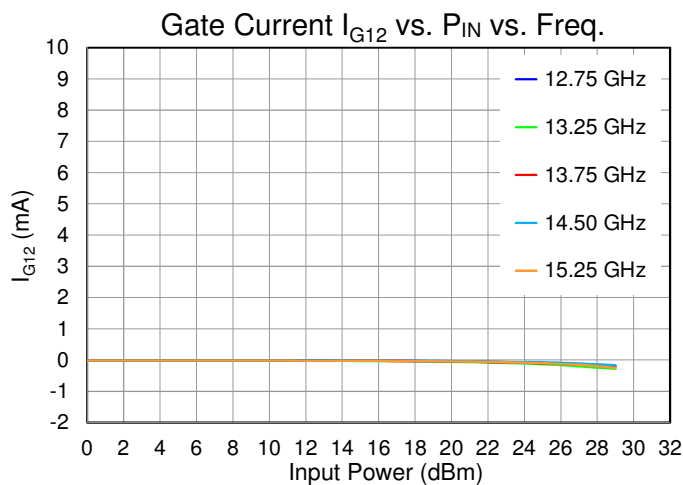
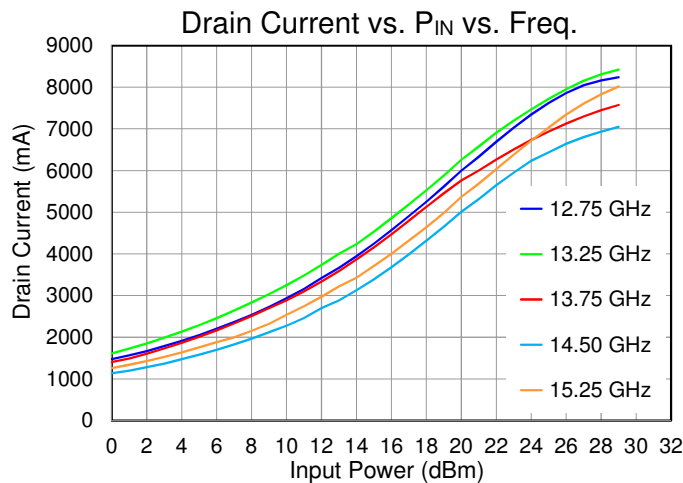
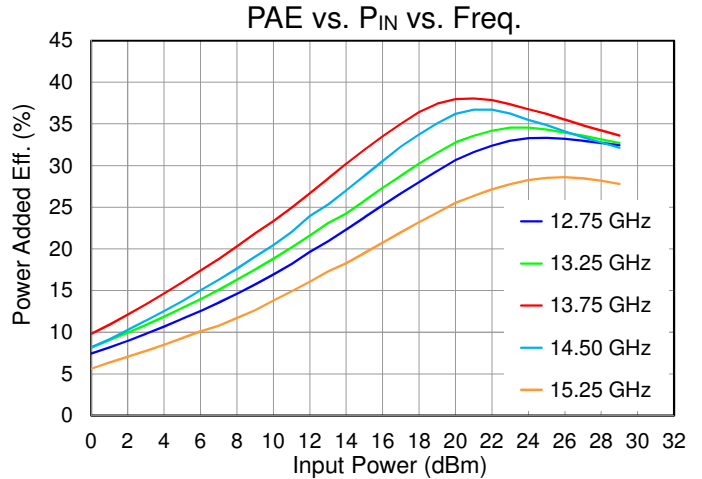
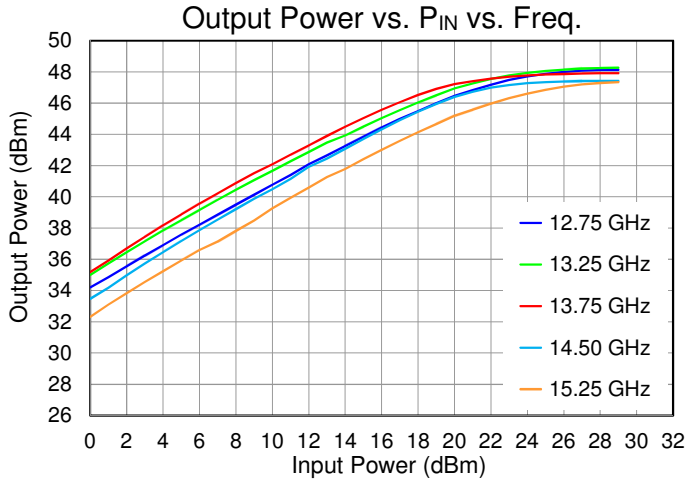

Performance Plots – Large Signal

Test conditions, unless otherwise noted: CW, $V_D = 24\text{ V}$, $I_{D12} = 168\text{ mA}$, $I_{D3} = 512\text{ mA}$, $P_{IN} = 25\text{ dBm}$, $T_{BASE} = +25\text{ }^\circ\text{C}$ (T_{BASE} is backside of QPA1314T)

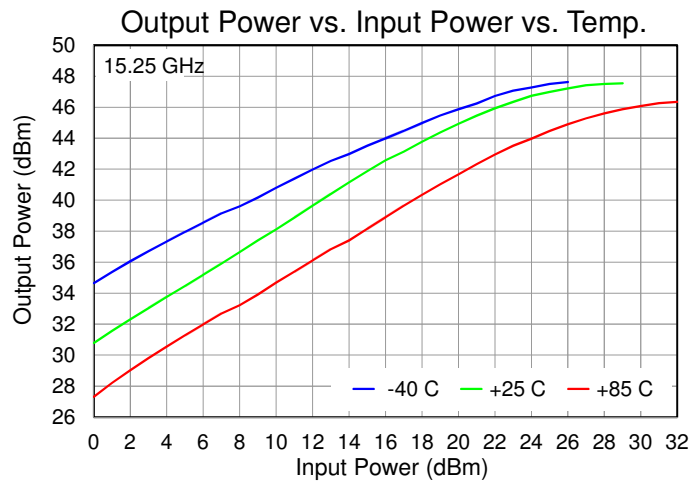
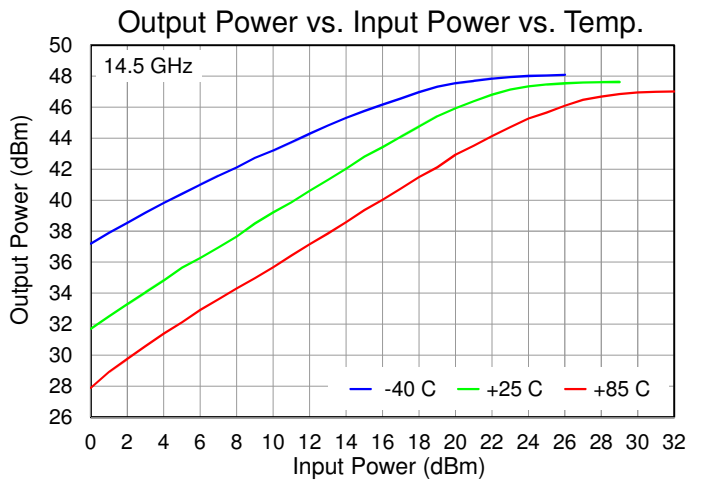
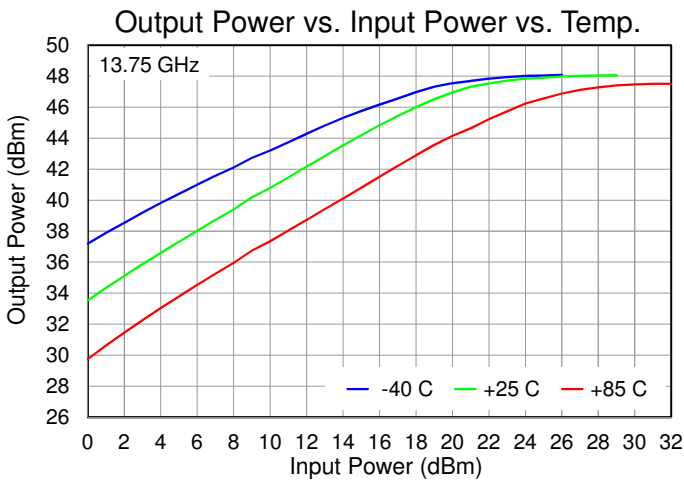
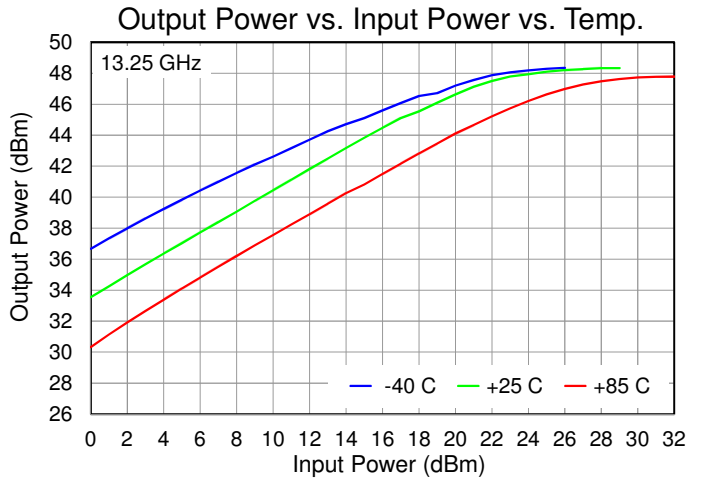
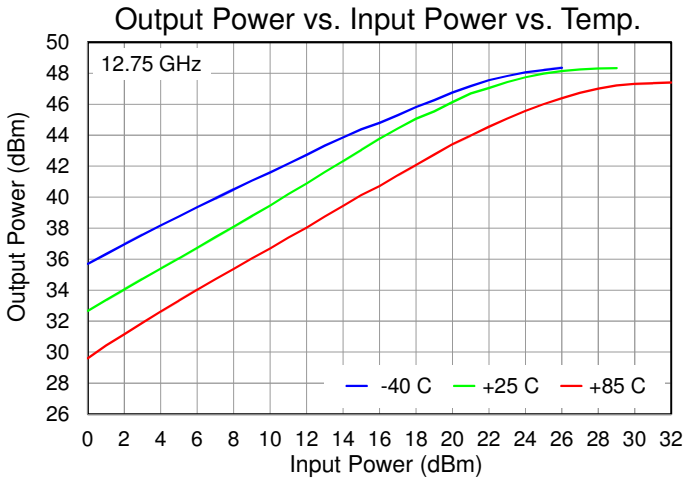

Performance Plots – Large Signal

Test conditions, unless otherwise noted: CW, $V_D = 24\text{ V}$, $I_{D12} = 168\text{ mA}$, $I_{D3} = 512\text{ mA}$, $P_{IN} = 25\text{ dBm}$, $T_{BASE} = +25\text{ }^\circ\text{C}$ (T_{BASE} is backside of QPA1314T)

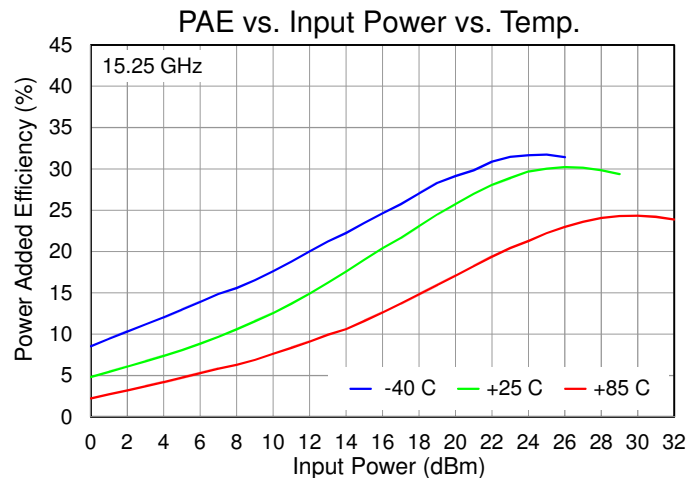
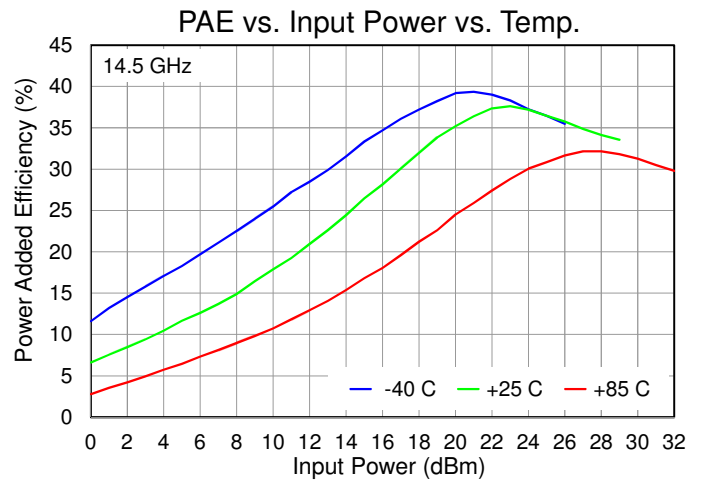
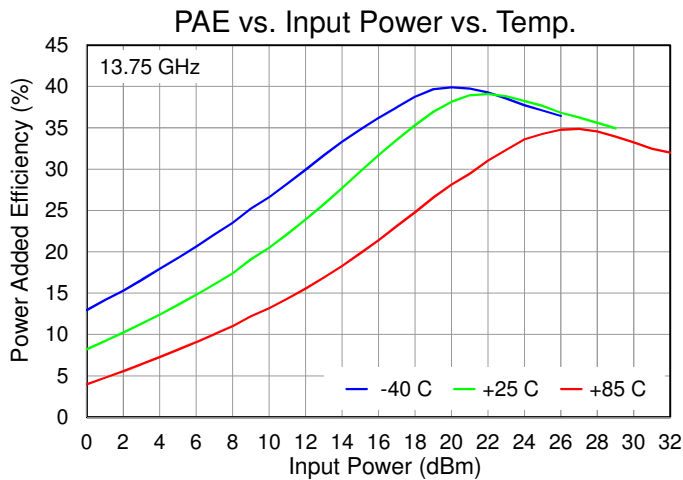
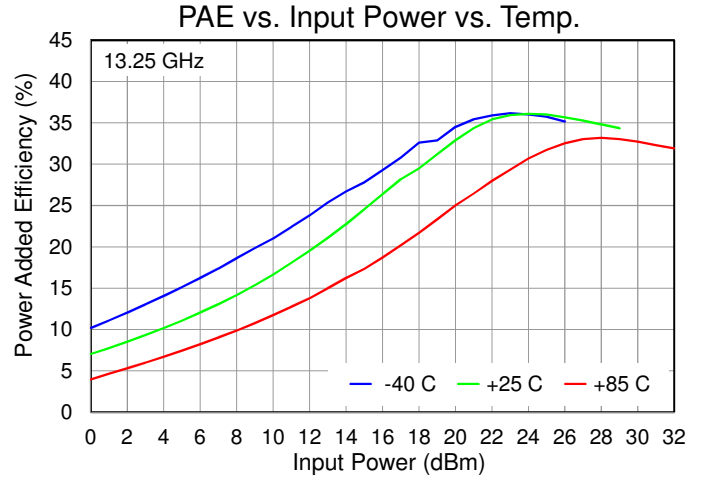
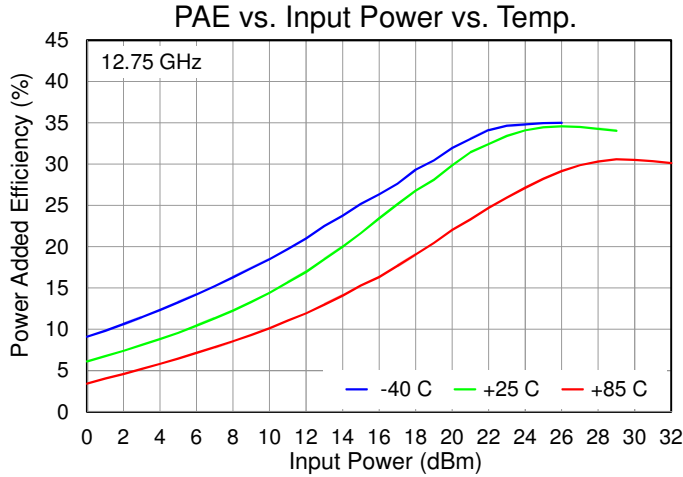

Performance Plots – Large Signal

Test conditions, unless otherwise noted: CW, $V_D = 24\text{ V}$, $I_{D12} = 168\text{ mA}$, $I_{D3} = 512\text{ mA}$, $P_{IN} = 25\text{ dBm}$, $T_{BASE} = +25\text{ }^\circ\text{C}$ (T_{BASE} is backside of QPA1314T)

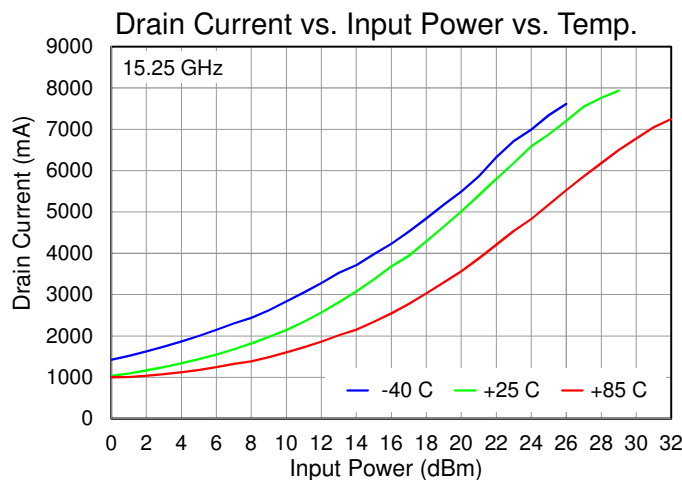
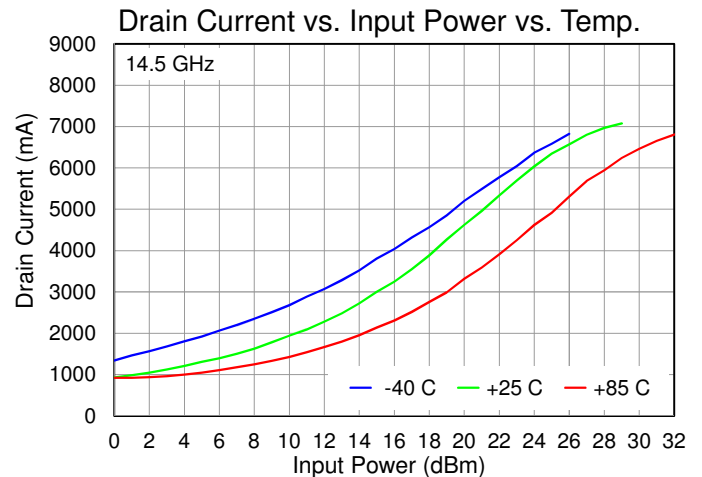
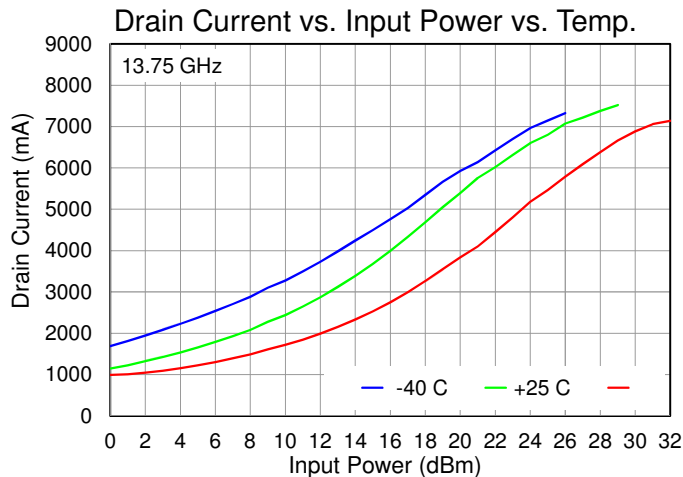
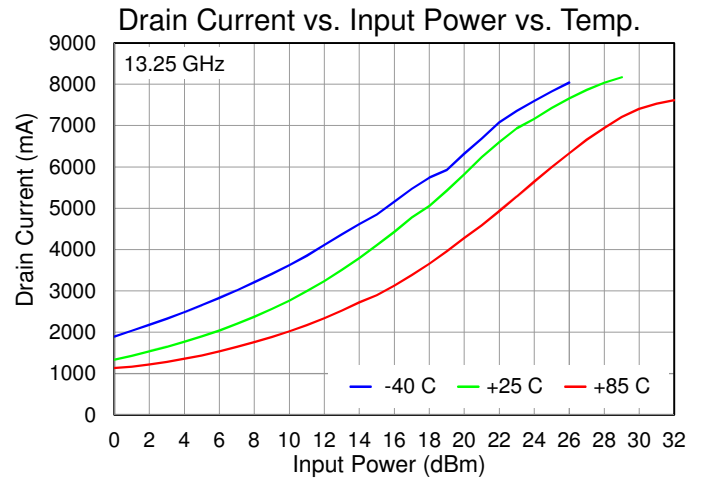
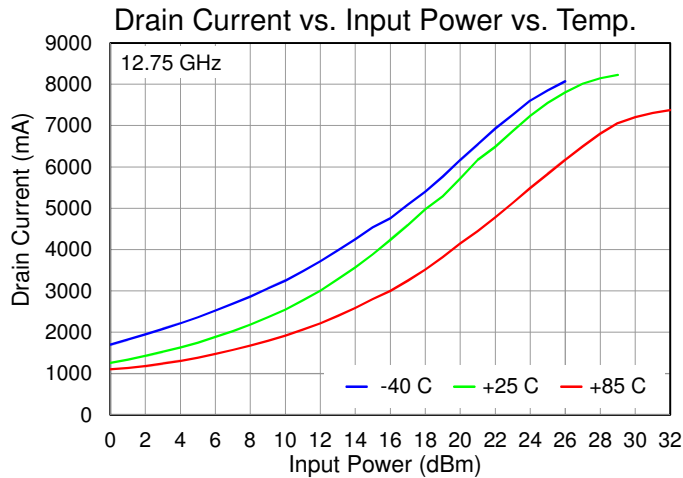

Performance Plots – Large Signal

Test conditions, unless otherwise noted: **CW**, $V_D = 24\text{ V}$, $I_{D12} = 168\text{ mA}$, $I_{D3} = 512\text{ mA}$, $P_{IN} = 25\text{ dBm}$, $T_{BASE} = +25\text{ }^\circ\text{C}$ (T_{BASE} is backside of QPA1314T)

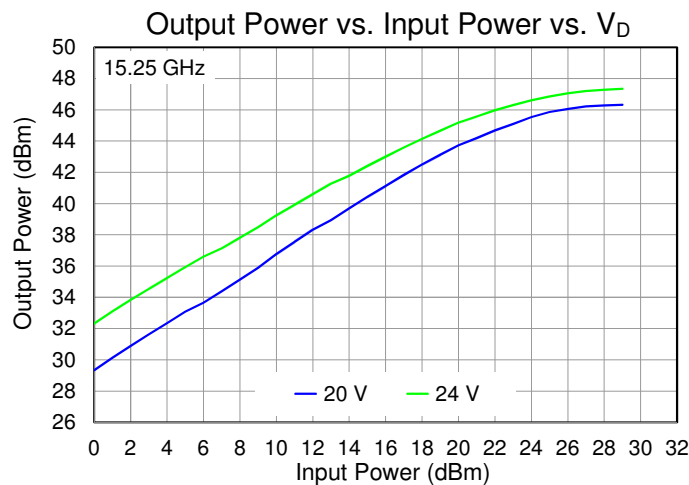
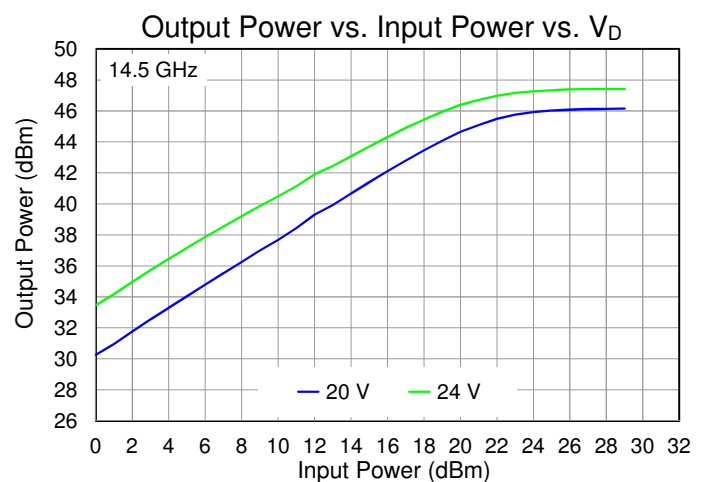
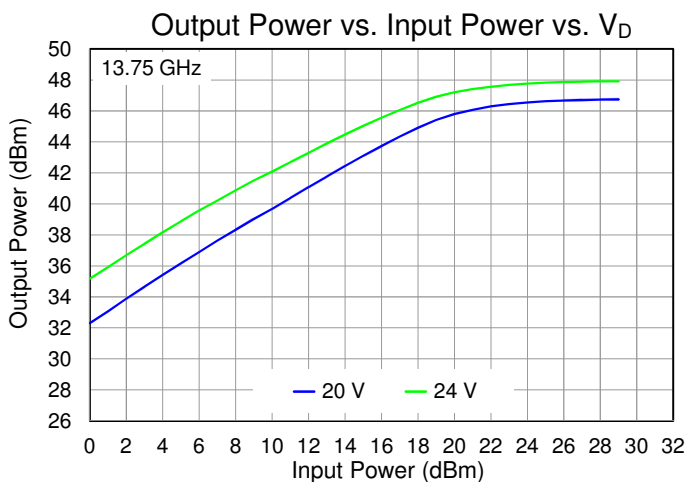
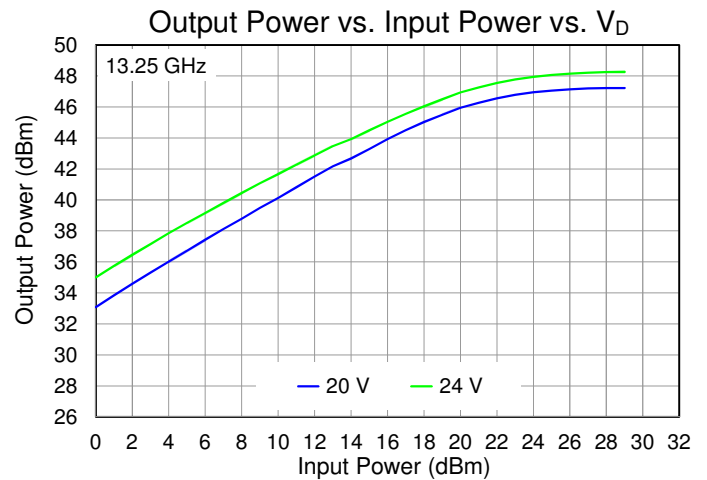
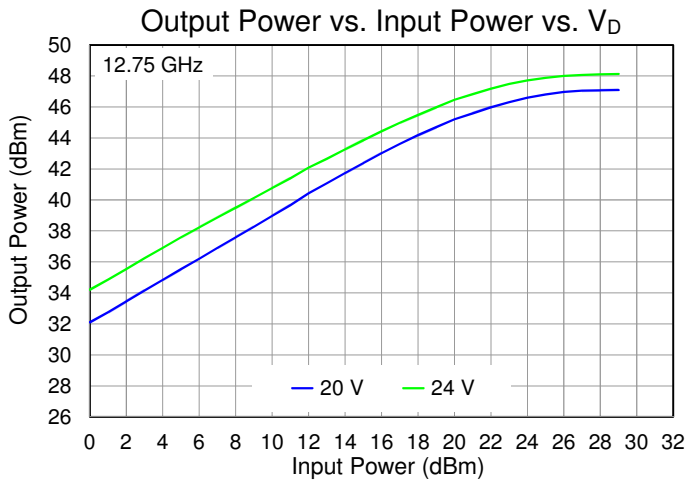

Performance Plots – Large Signal

Test conditions, unless otherwise noted: CW, $V_D = 24\text{ V}$, $I_{D12} = 168\text{ mA}$, $I_{D3} = 512\text{ mA}$, $P_{IN} = 25\text{ dBm}$, $T_{BASE} = +25\text{ }^\circ\text{C}$ (T_{BASE} is backside of QPA1314T)

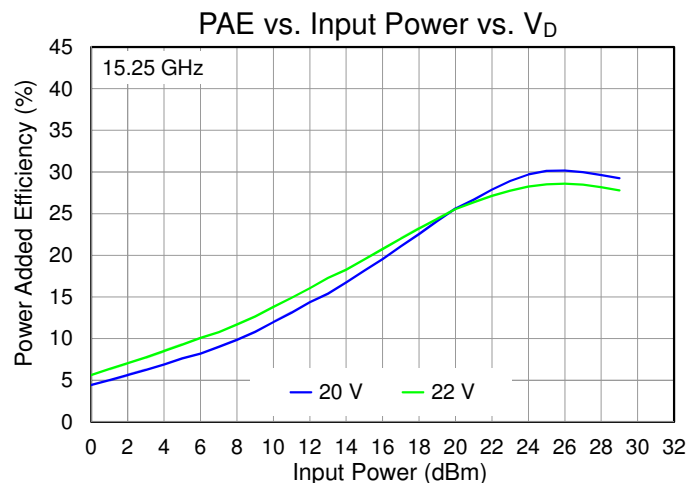
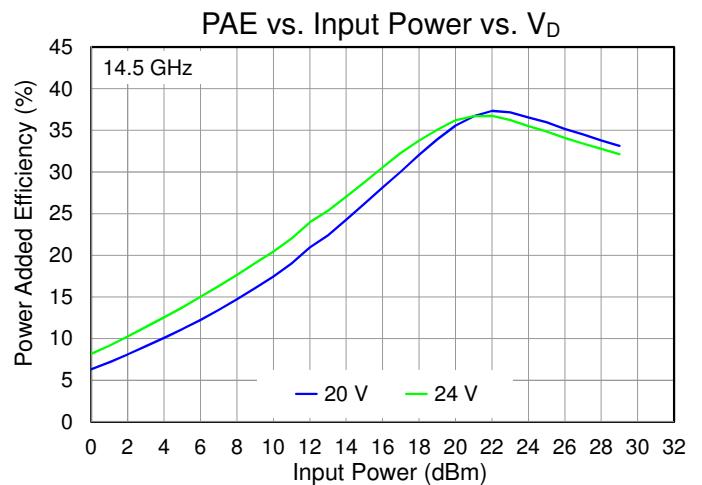
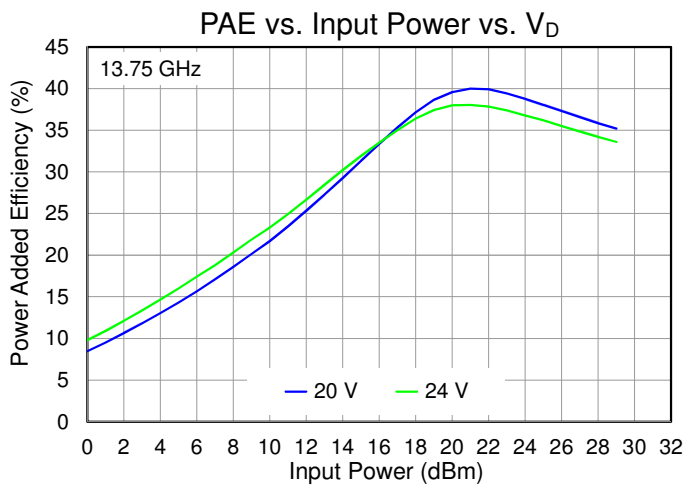
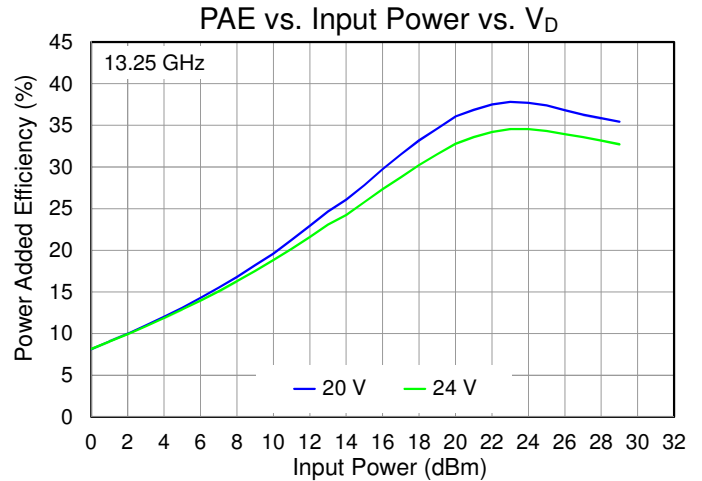
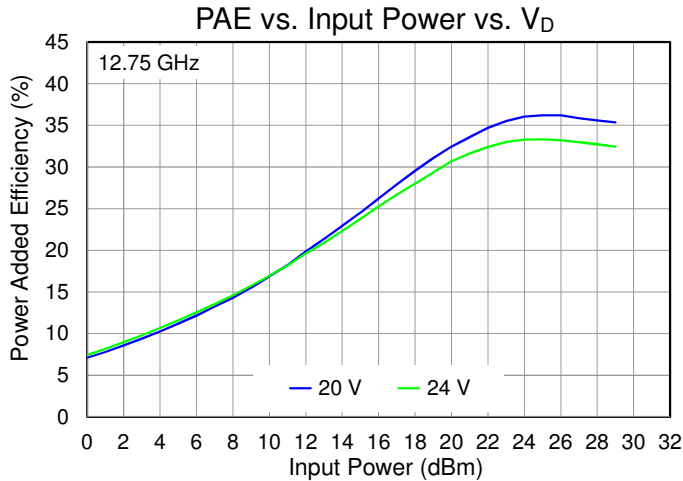

Performance Plots – Large Signal

Test conditions, unless otherwise noted: CW, $V_D = 24\text{ V}$, $I_{D12} = 168\text{ mA}$, $I_{D3} = 512\text{ mA}$, $P_{IN} = 25\text{ dBm}$, $T_{BASE} = +25\text{ }^\circ\text{C}$ (T_{BASE} is backside of QPA1314T)

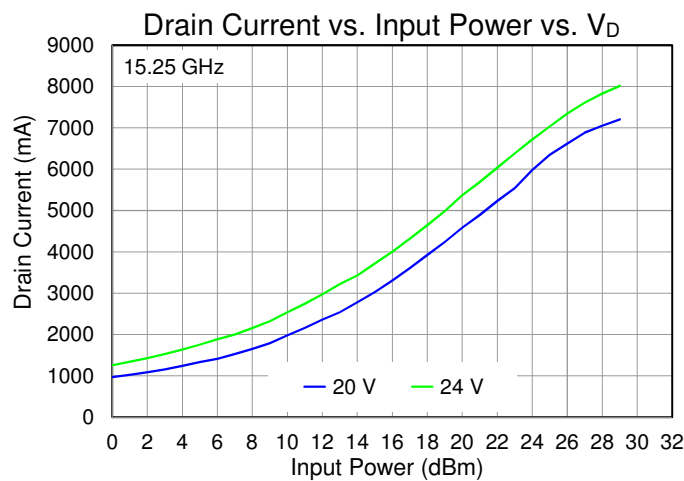
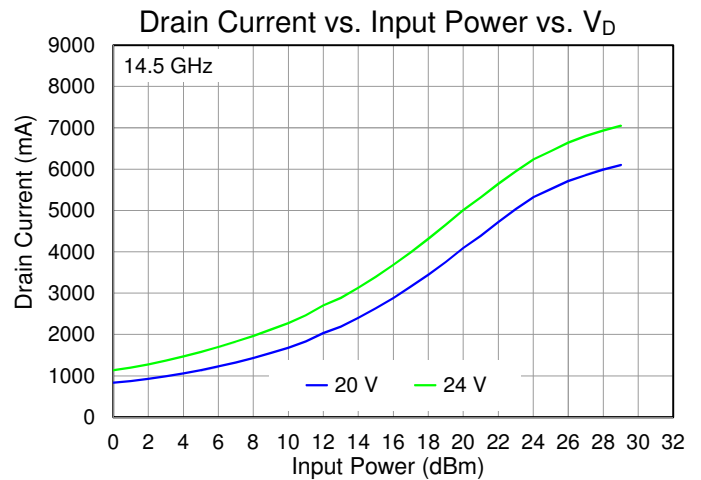
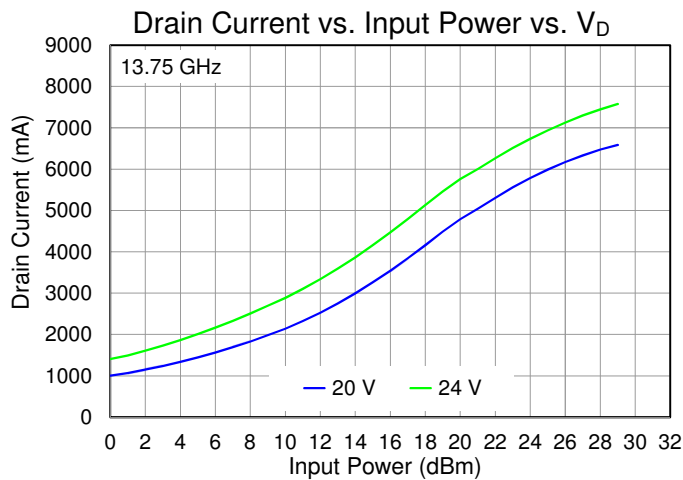
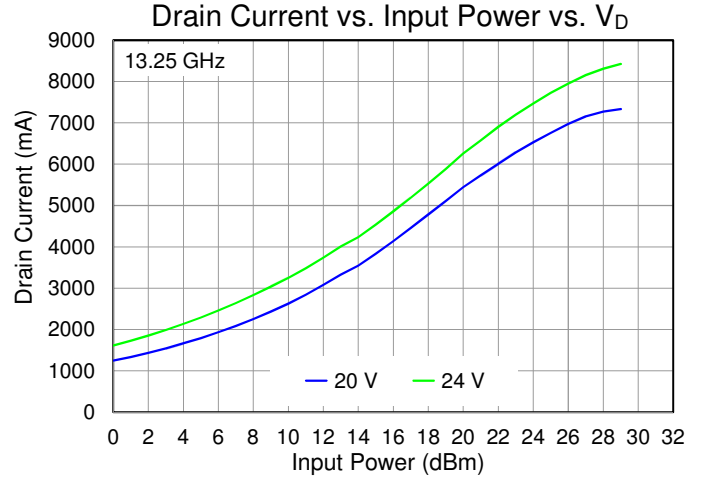
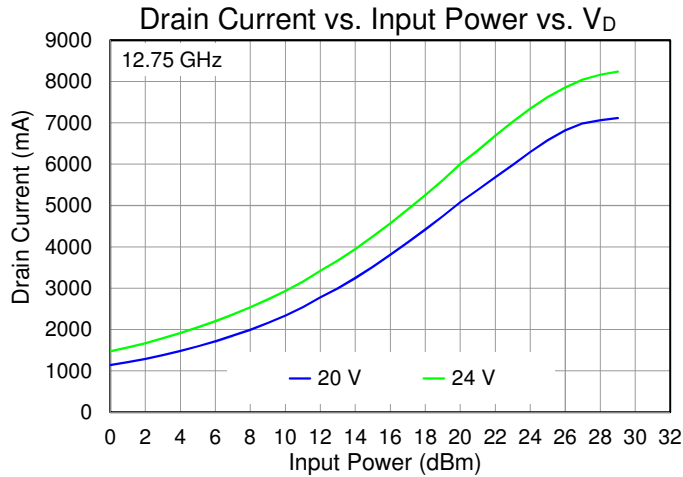

Performance Plots – Large Signal

Test conditions, unless otherwise noted: **CW**, $V_D = 24\text{ V}$, $I_{D12} = 168\text{ mA}$, $I_{D3} = 512\text{ mA}$, $P_{IN} = 25\text{ dBm}$, $T_{BASE} = +25\text{ }^\circ\text{C}$ (T_{BASE} is backside of QPA1314T)

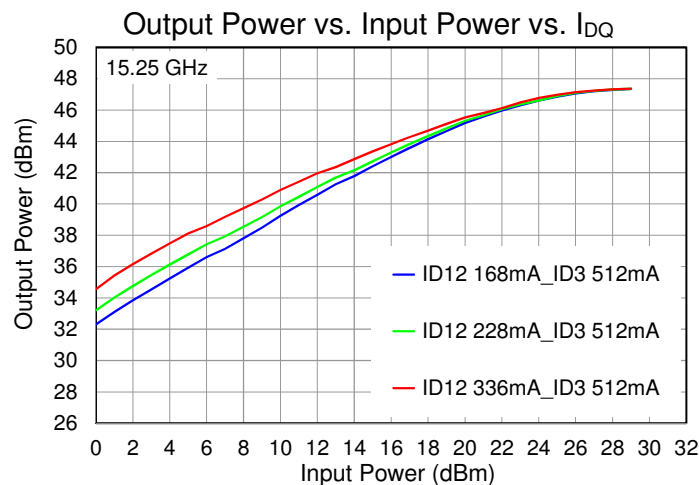
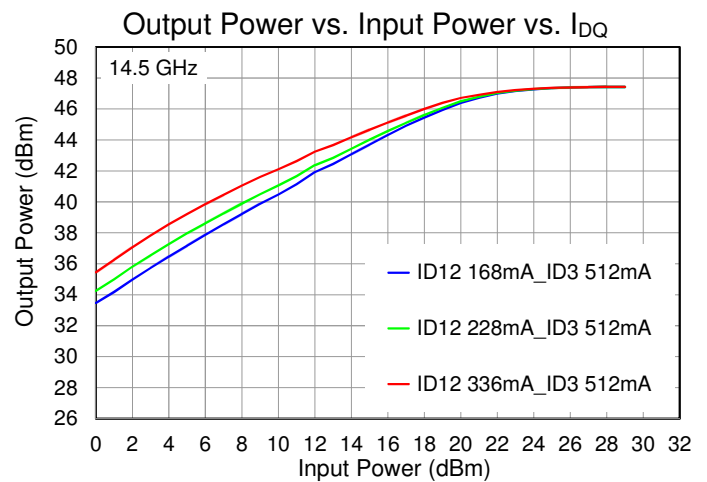
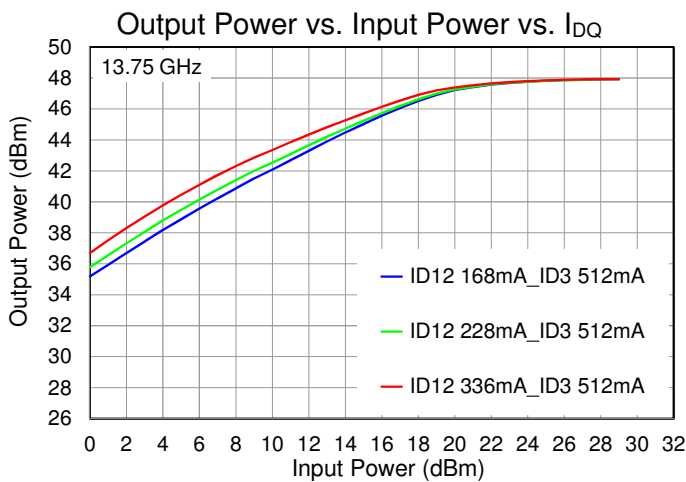
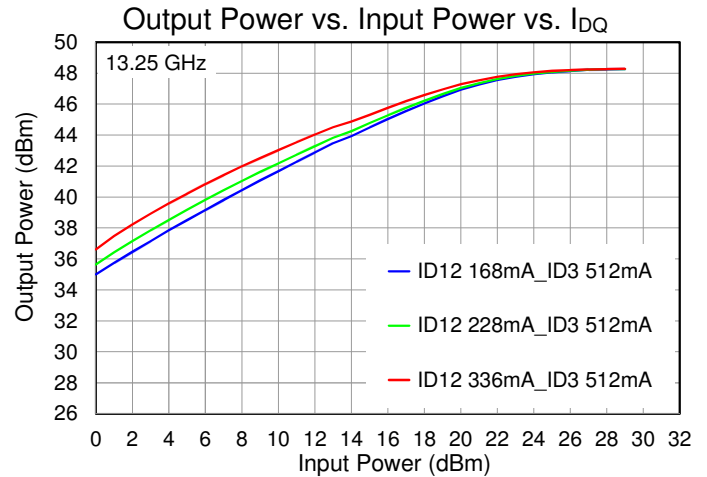
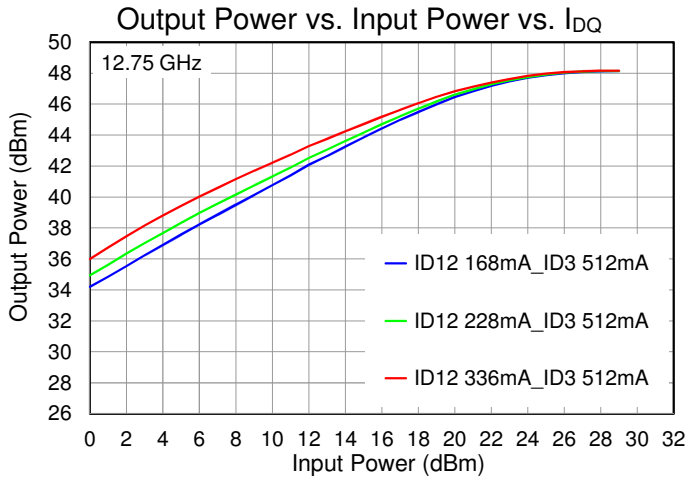

Performance Plots – Large Signal

Test conditions, unless otherwise noted: **CW**, $V_D = 24\text{ V}$, $I_{D12} = 168\text{ mA}$, $I_{D3} = 512\text{ mA}$, $P_{IN} = 25\text{ dBm}$, $T_{BASE} = +25\text{ }^\circ\text{C}$ (T_{BASE} is backside of QPA1314T)

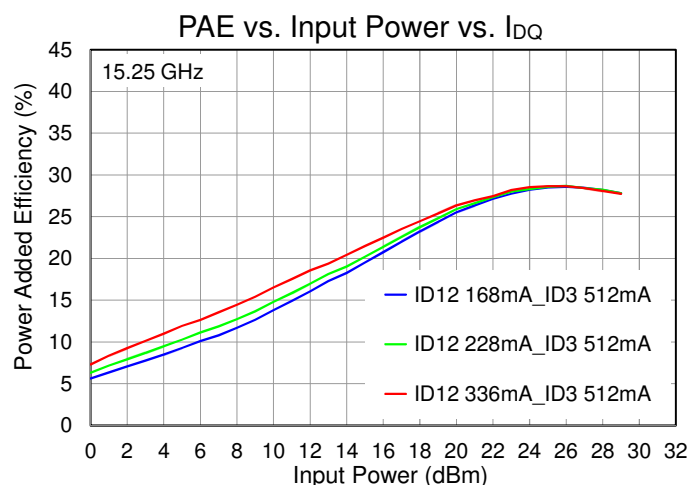
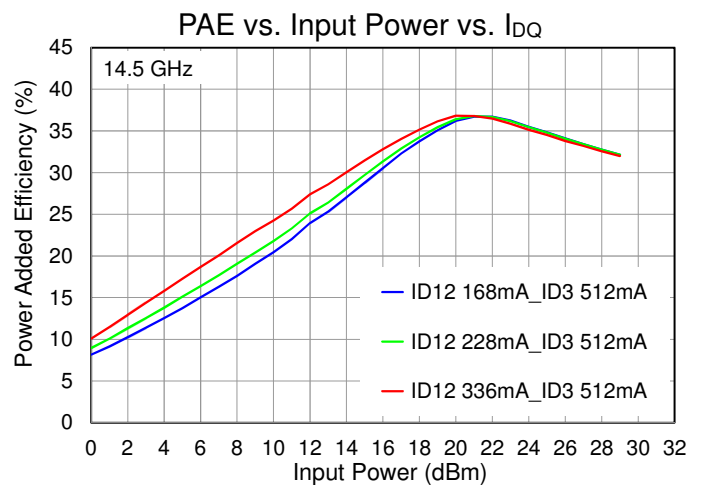
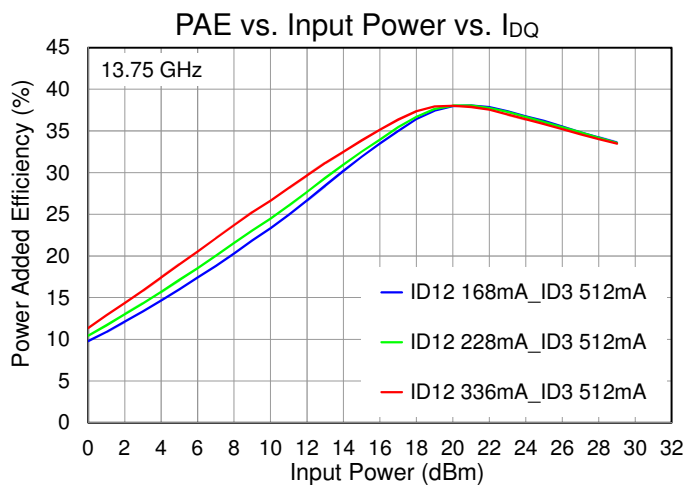
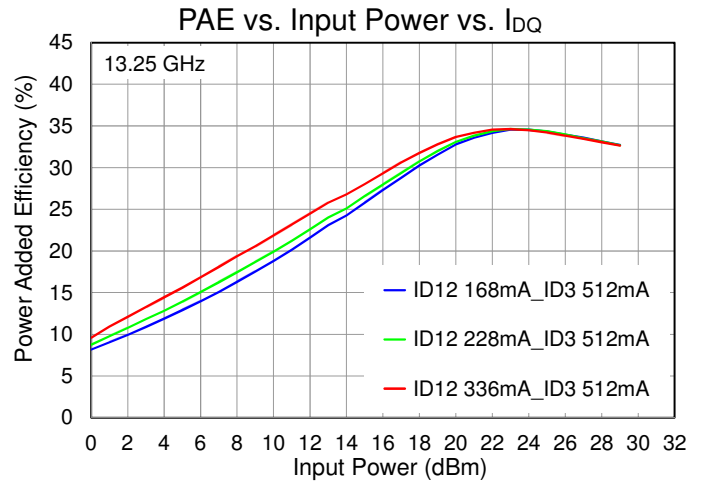
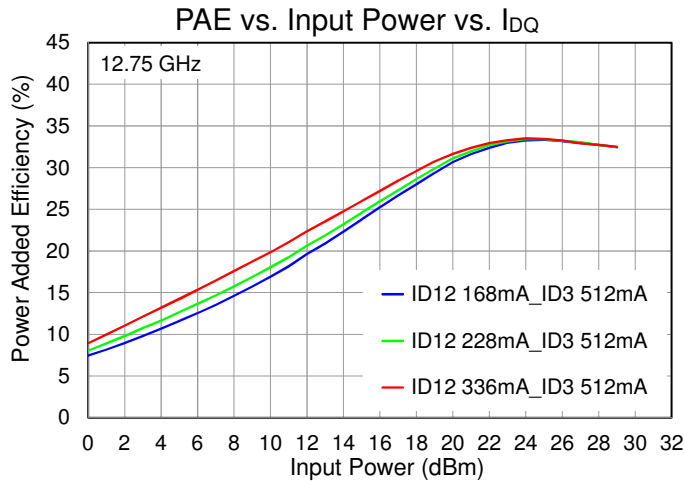

Performance Plots – Large Signal

Test conditions, unless otherwise noted: CW, $V_D = 24\text{ V}$, $I_{D12} = 168\text{ mA}$, $I_{D3} = 512\text{ mA}$, $P_{IN} = 25\text{ dBm}$, $T_{BASE} = +25\text{ }^\circ\text{C}$ (T_{BASE} is backside of QPA1314T)

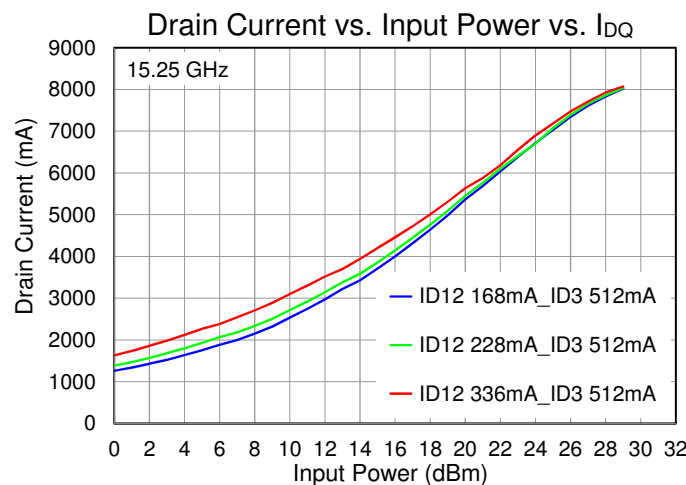
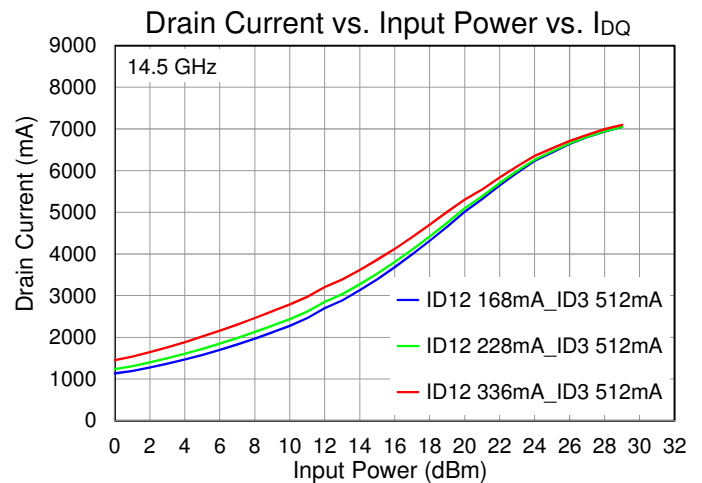
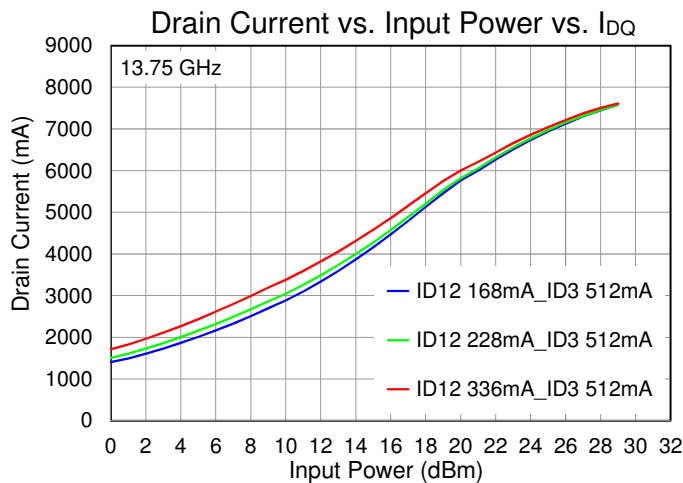
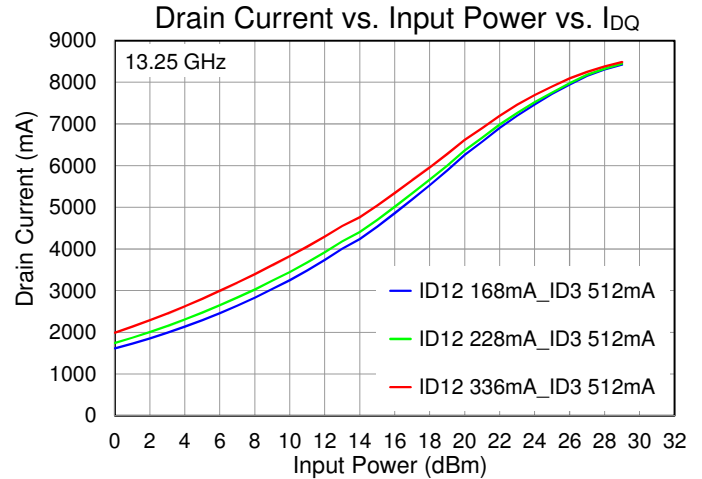
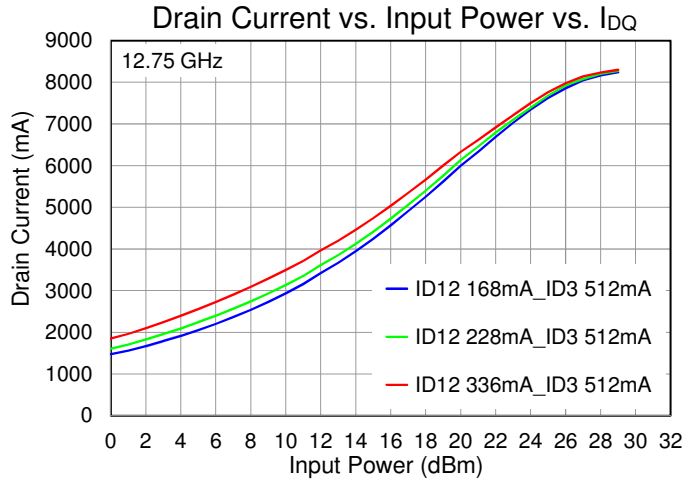

Performance Plots – Linearity

Test conditions, unless otherwise noted: CW, $V_D = 24\text{ V}$, $\Delta f = 10\text{ MHz}$, $T_{BASE} = +25\text{ }^\circ\text{C}$ (T_{BASE} is backside of QPA1314T)

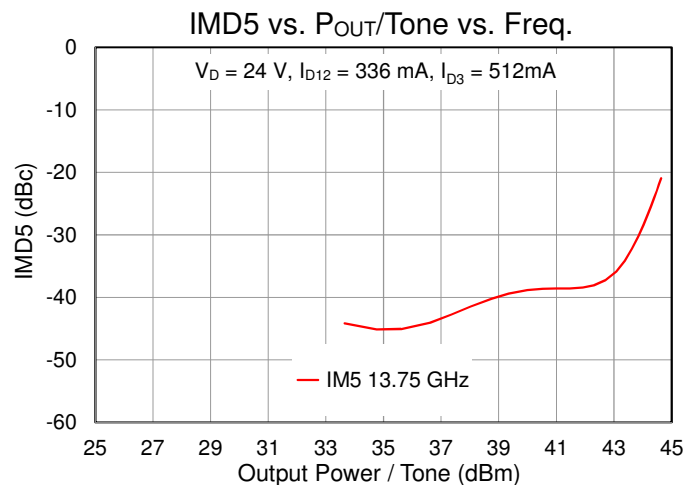
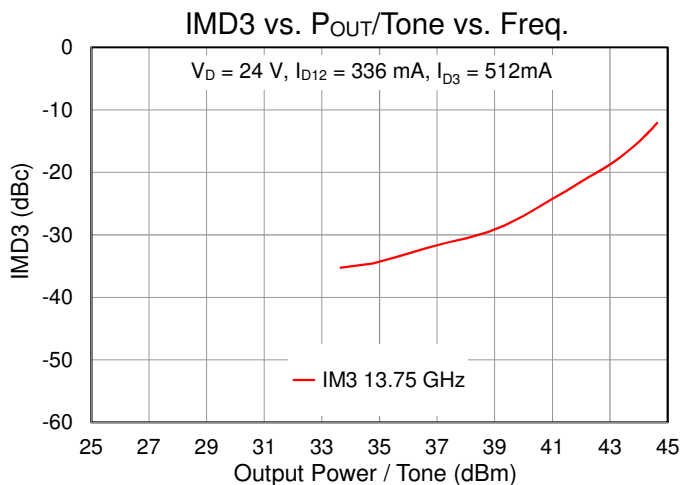
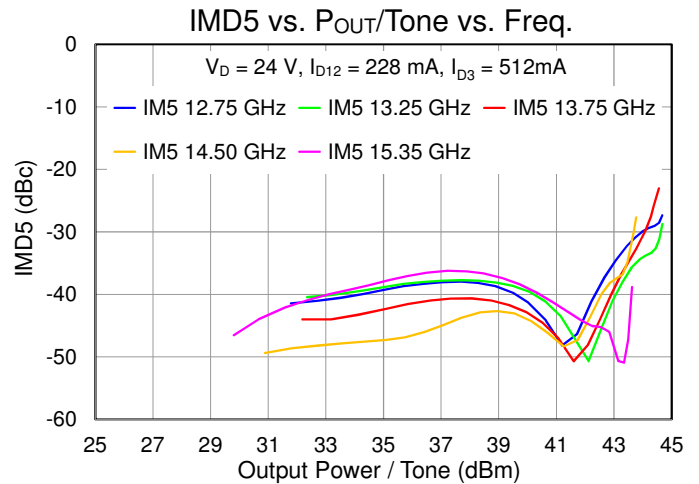
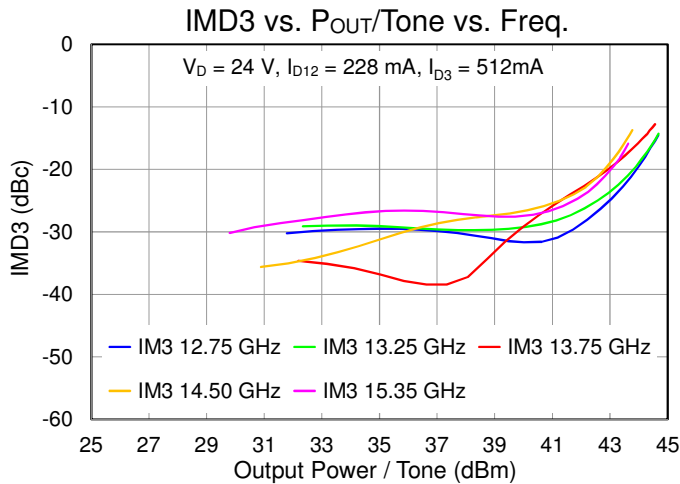
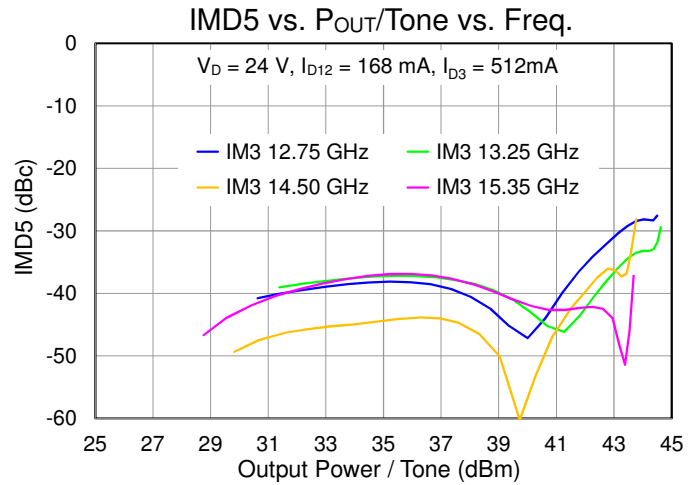
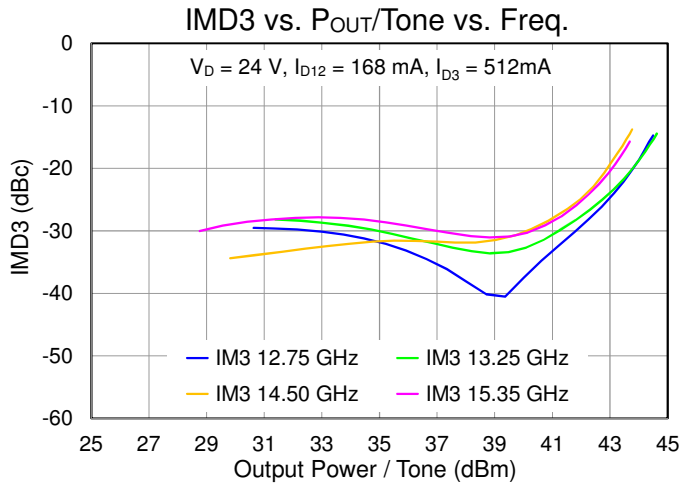

Performance Plots – Linearity

Test conditions, unless otherwise noted: CW, $V_D = 24\text{ V}$, $\Delta f = 10\text{ MHz}$, $T_{BASE} = +25\text{ }^\circ\text{C}$ (T_{BASE} is backside of QPA1314T)

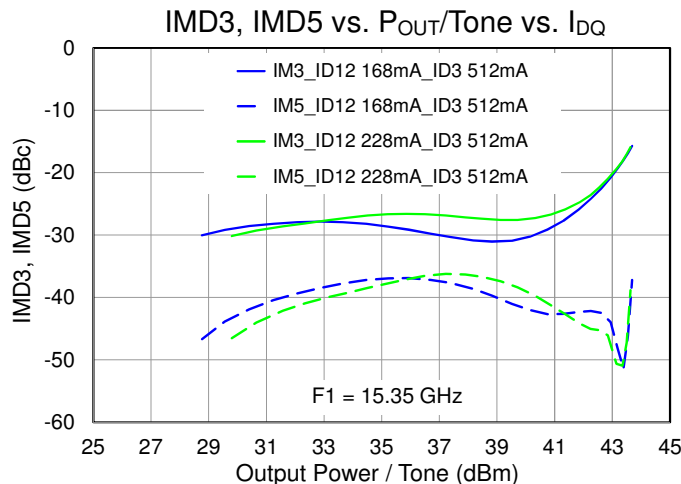
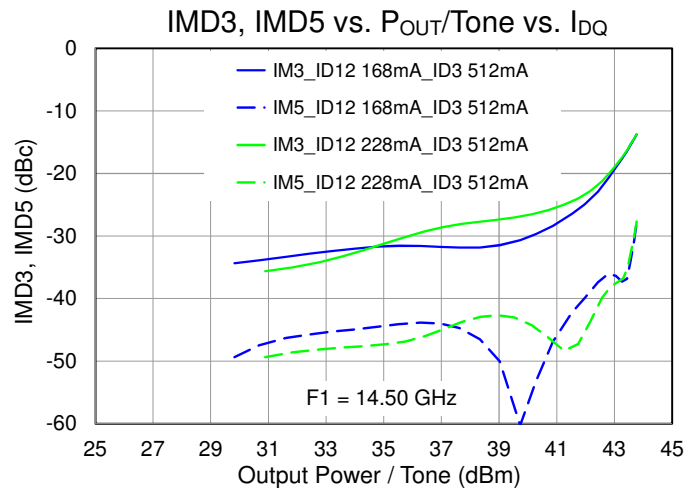
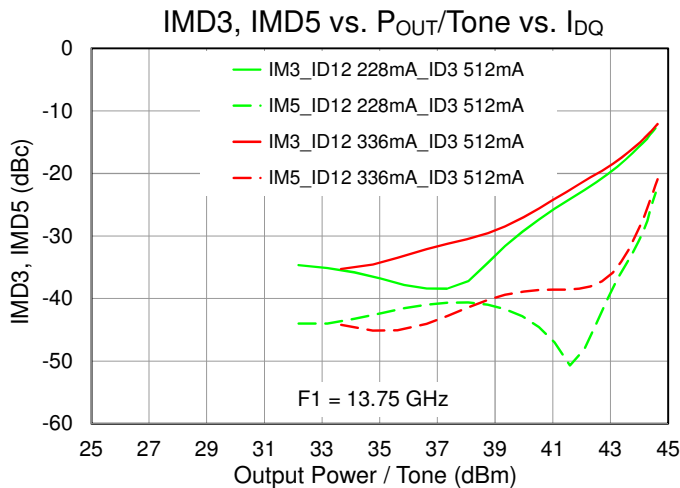
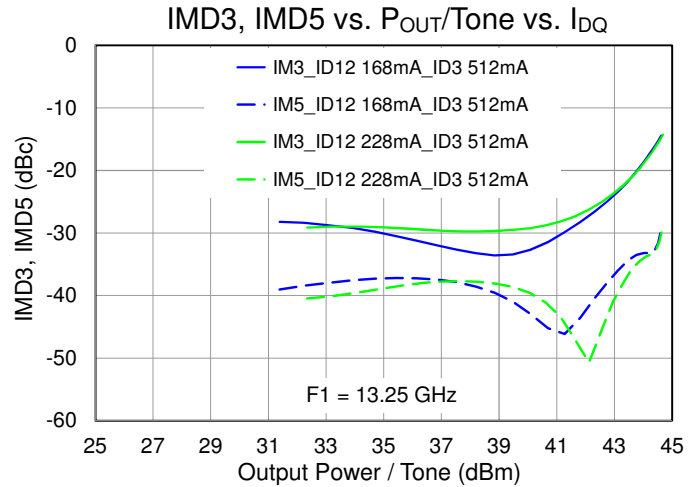
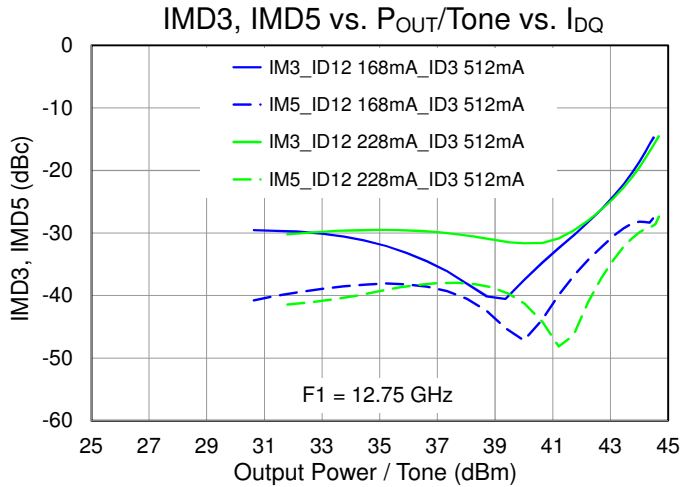

Performance Plots – Linearity

Test conditions, unless otherwise noted: CW, $V_D = 24\text{ V}$, $I_{D12} = 238\text{ mA}$, $I_{D3} = 512\text{ mA}$, $T_{BASE} = +25\text{ }^\circ\text{C}$ (T_{BASE} is backside of QPA1314T)

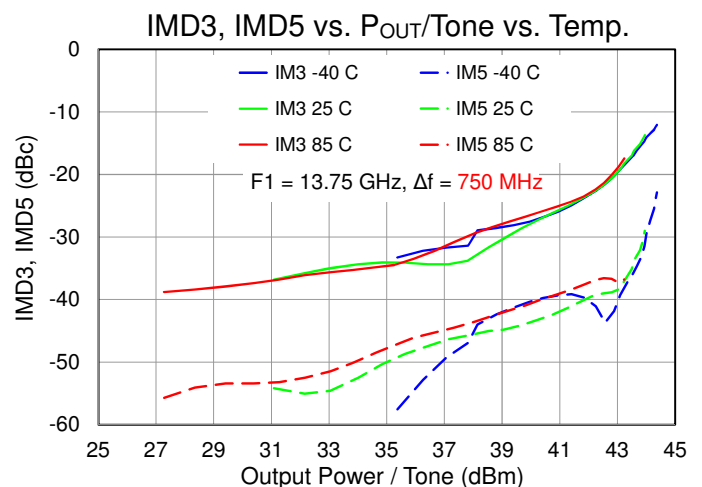
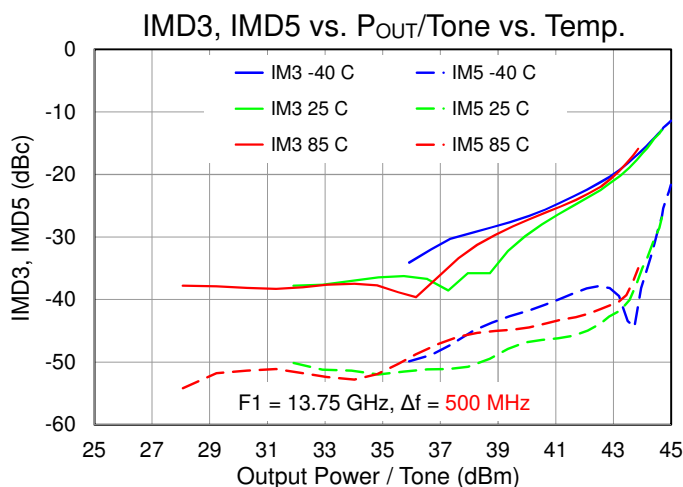
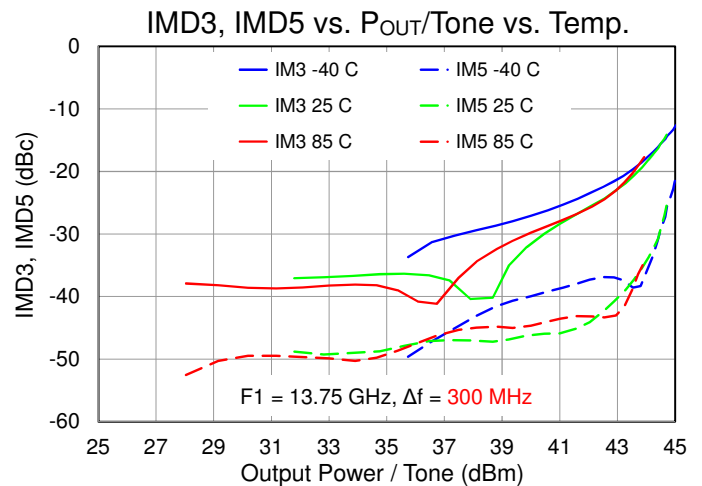
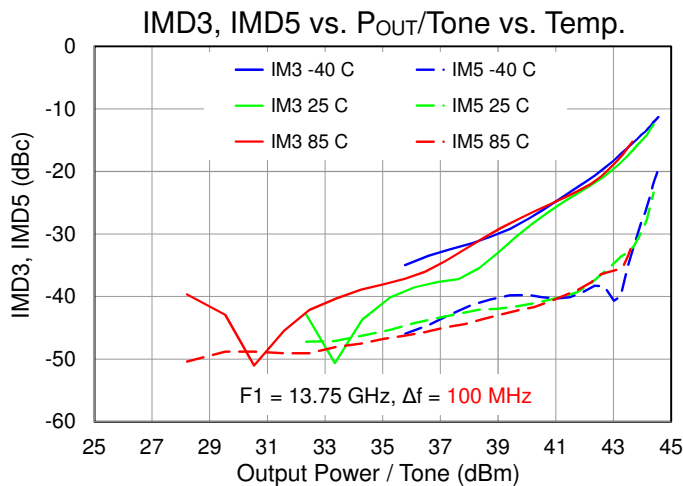
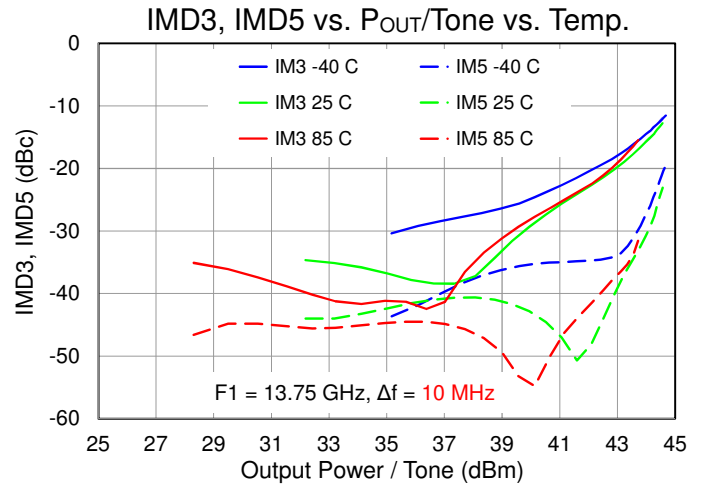
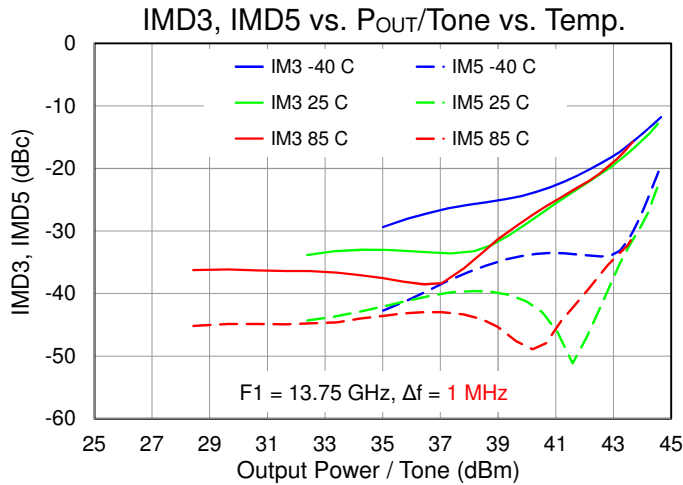

Performance Plots – Linearity

Test conditions, unless otherwise noted: CW, $V_D = 24\text{ V}$, $T_{BASE} = +25\text{ }^\circ\text{C}$ (T_{BASE} is backside of QPA1314T)

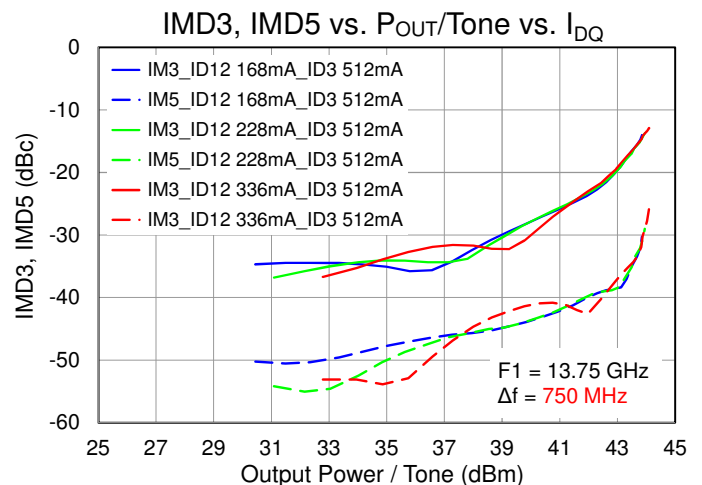
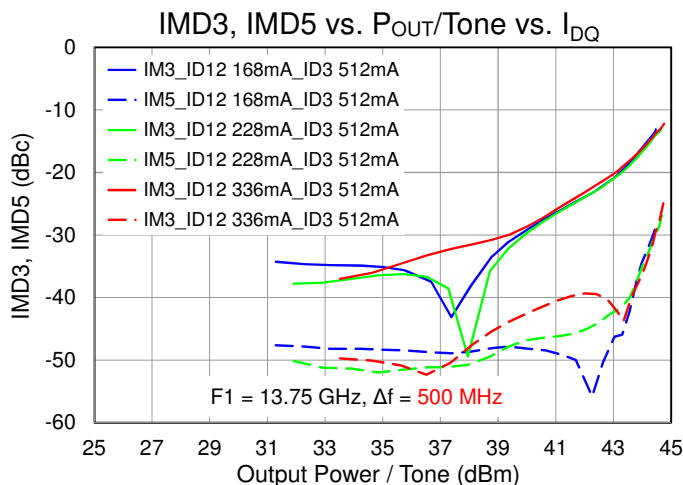
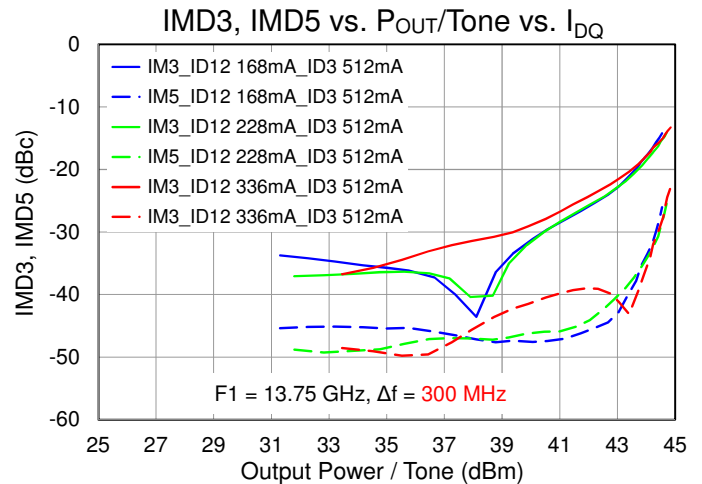
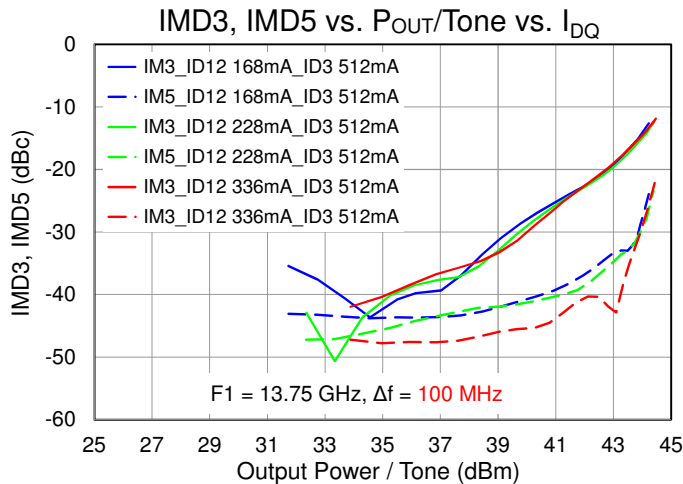
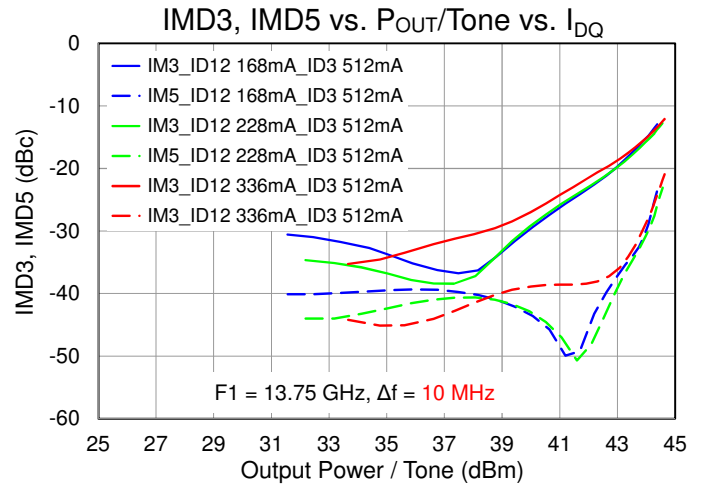
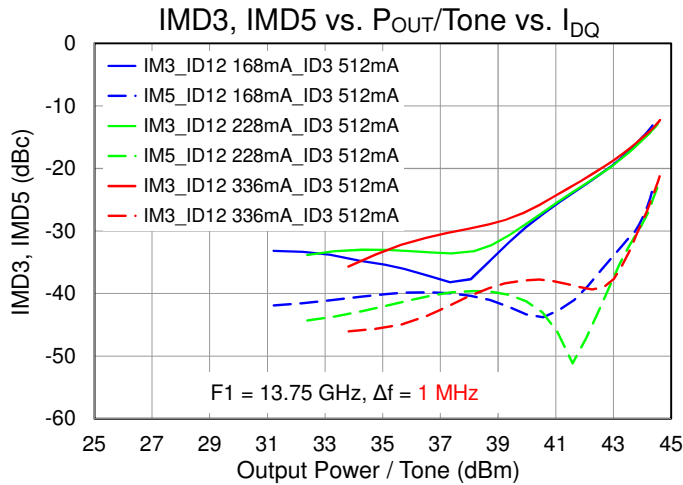

Performance Plots – Large Signal

Test conditions, unless otherwise noted: CW, $V_D = 24\text{ V}$, $T_{BASE} = +25\text{ }^\circ\text{C}$ (T_{BASE} is backside of QPA1314T)

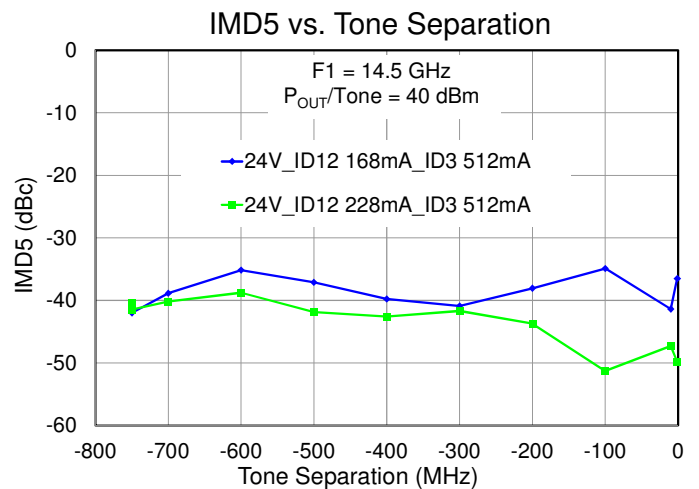
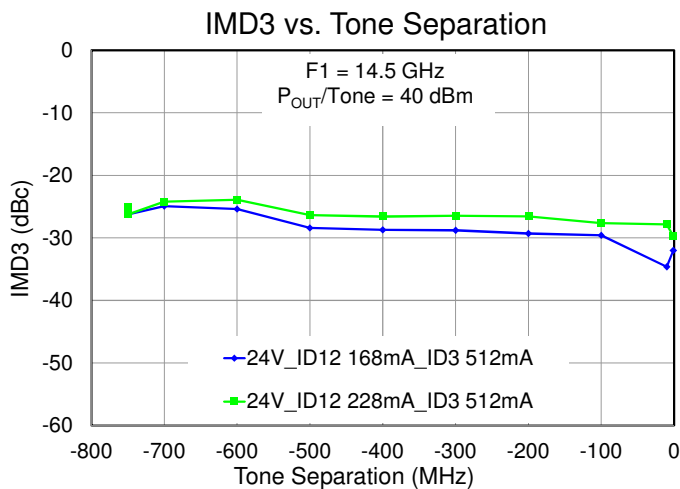
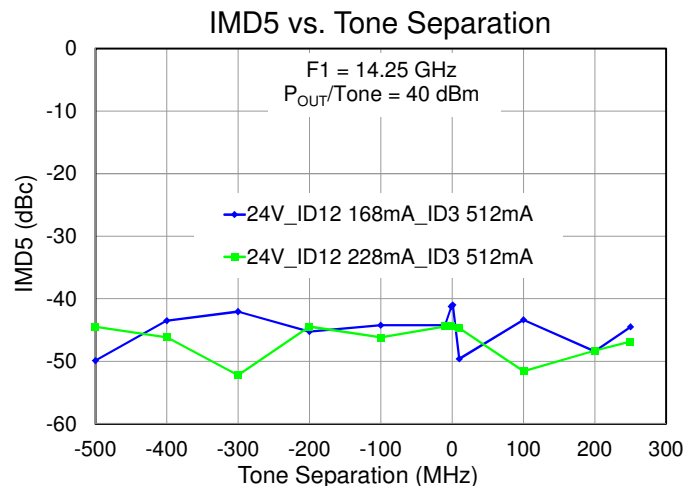
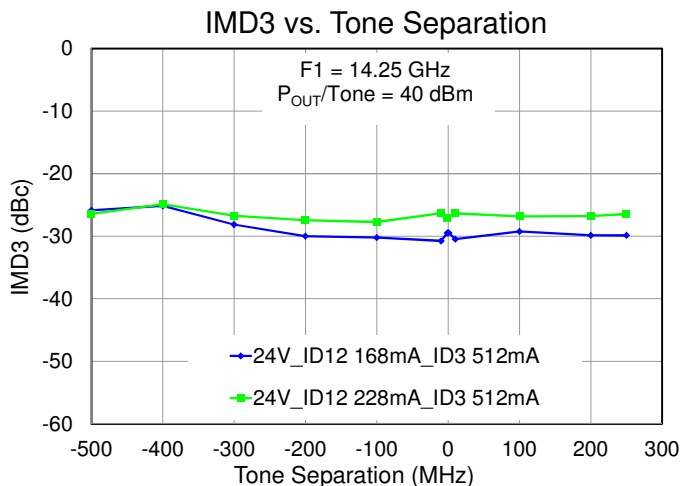
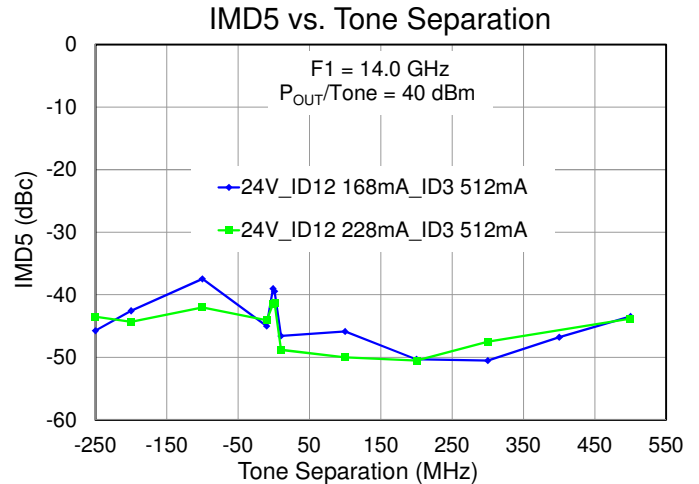
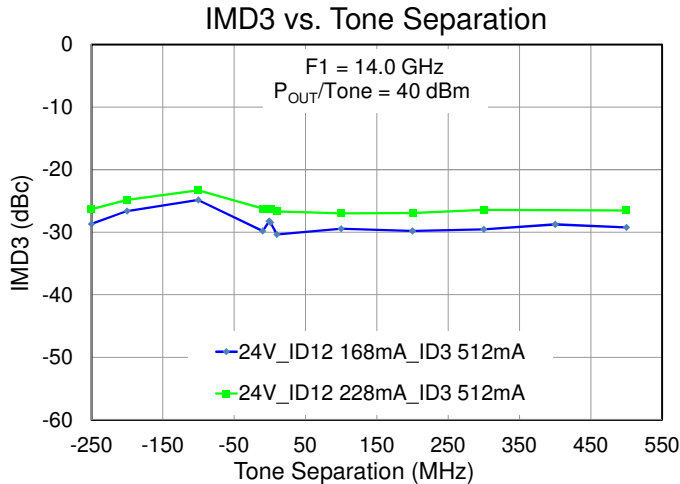

Performance Plots – Linearity

Test conditions, unless otherwise noted: CW, $V_D = 24\text{ V}$, $T_{BASE} = +25\text{ }^\circ\text{C}$ (T_{BASE} is backside of QPA1314T)

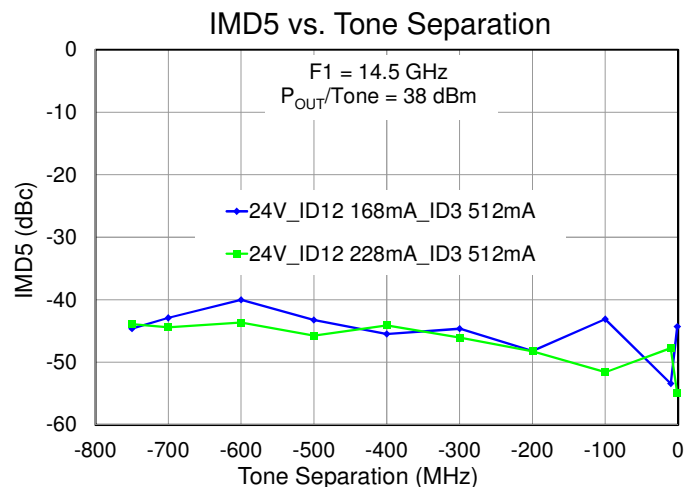
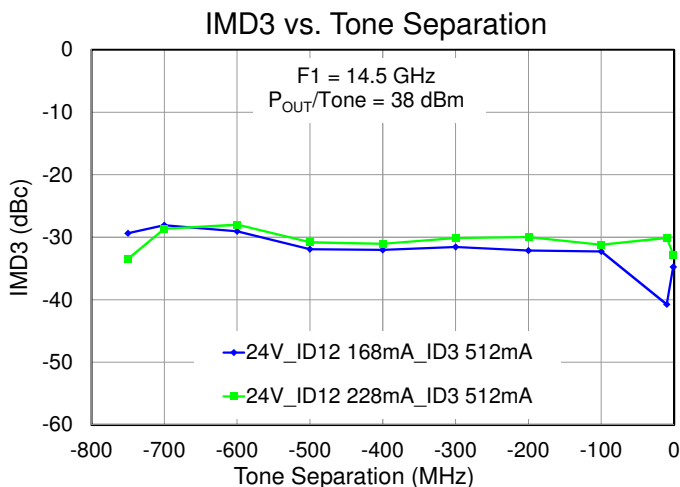
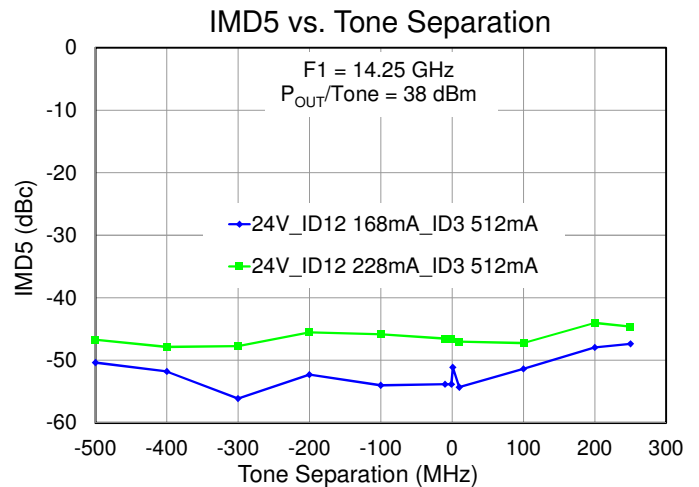
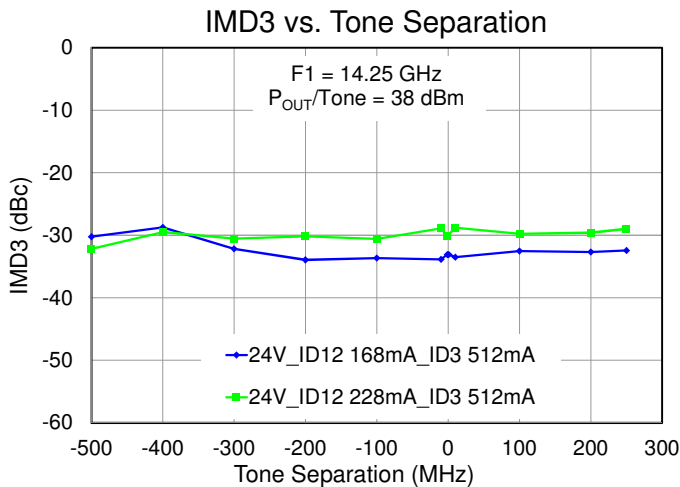
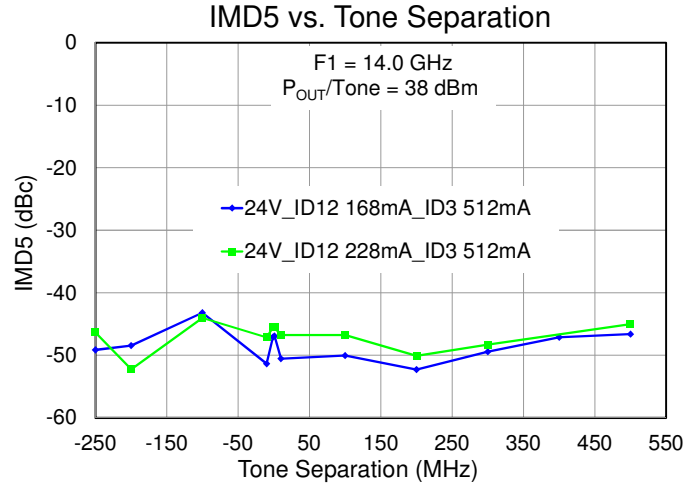
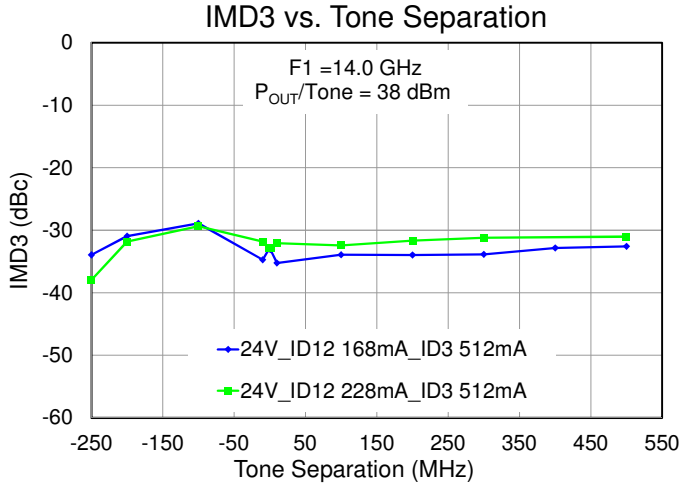

Performance Plots – Small Signal

Test conditions, unless otherwise noted: **CW**, $V_D = 24\text{ V}$, $I_{D12} = 168\text{ mA}$, $I_{D3} = 512\text{ mA}$, $P_{IN} = -30\text{ dBm}$, $T_{BASE} = +25\text{ }^\circ\text{C}$ (T_{BASE} is backside of QPA1314T)

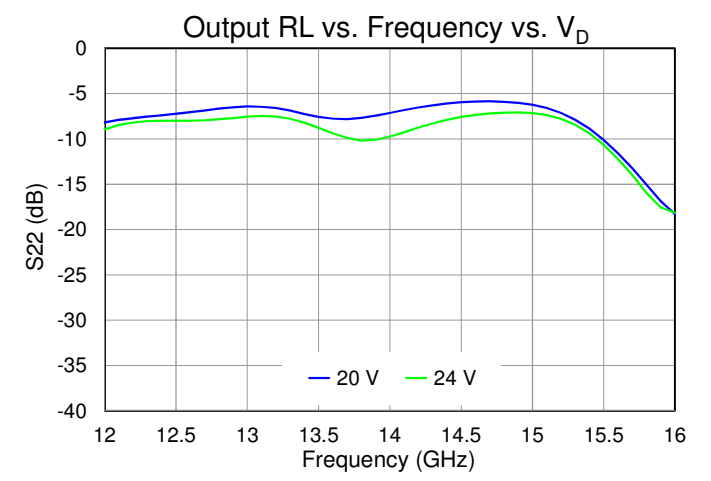
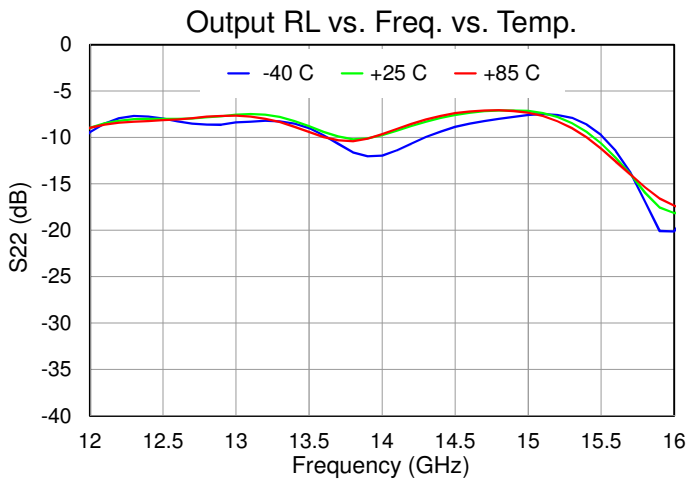
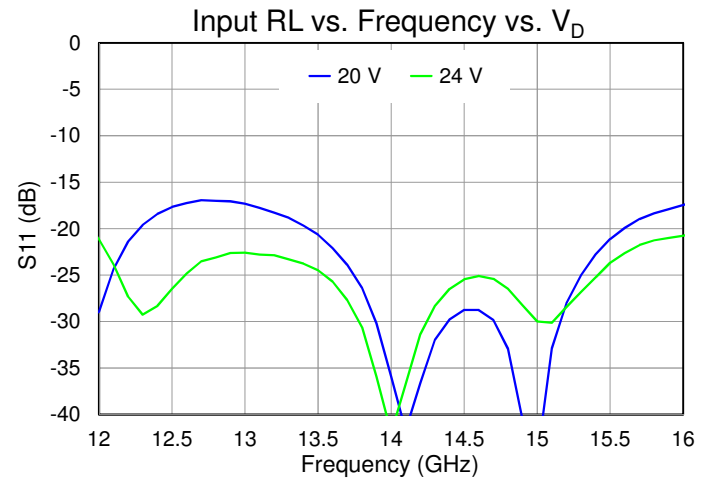
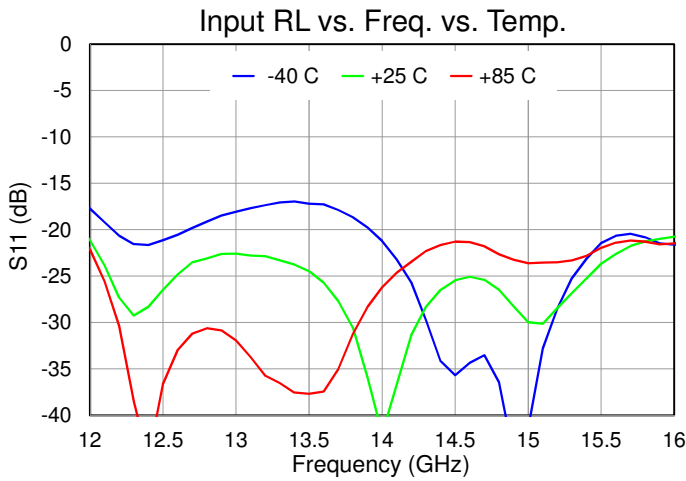
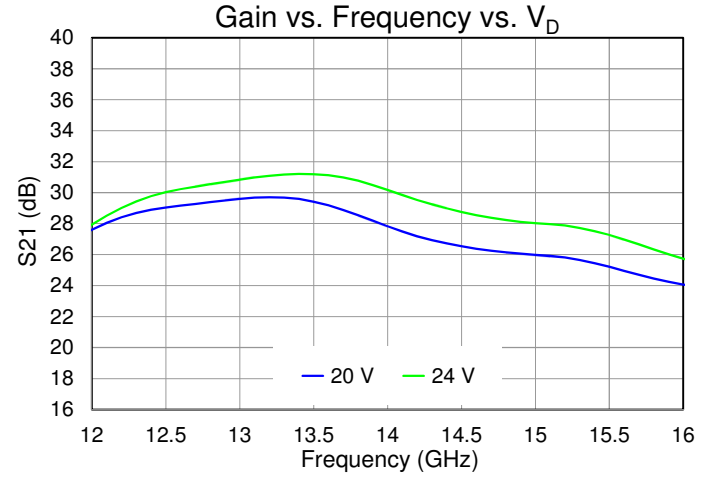
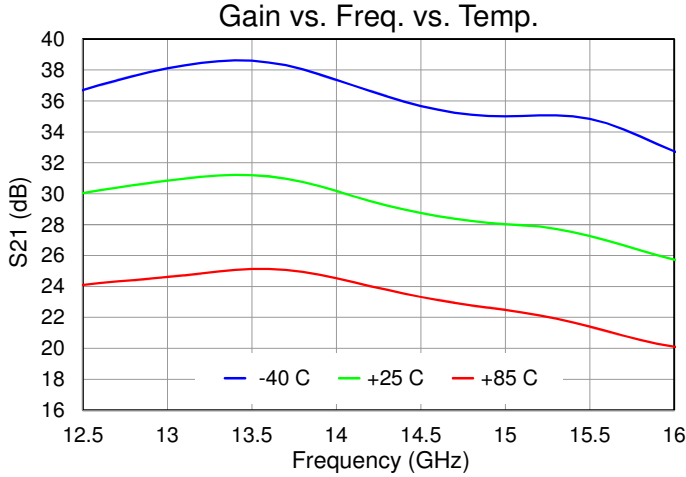

Performance Plots – Small Signal

Test conditions, unless otherwise noted: CW, $V_D = 24\text{ V}$, $I_{D12} = 168\text{ mA}$, $I_{D3} = 512\text{ mA}$, $P_{IN} = -30\text{ dBm}$, $T_{BASE} = +25\text{ }^\circ\text{C}$ (T_{BASE} is backside of QPA1314T)

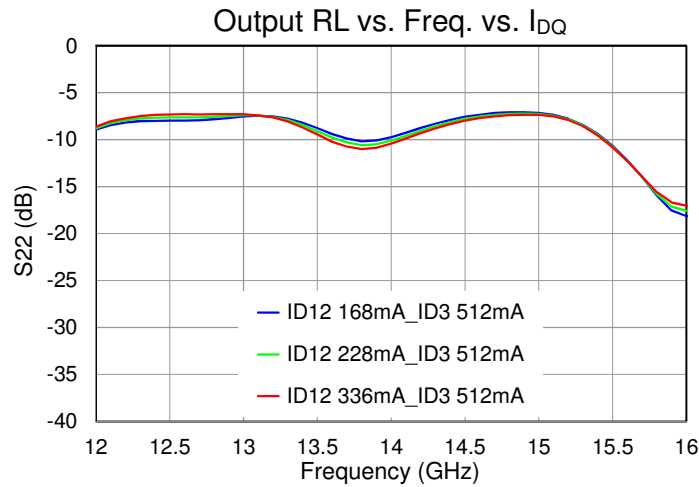
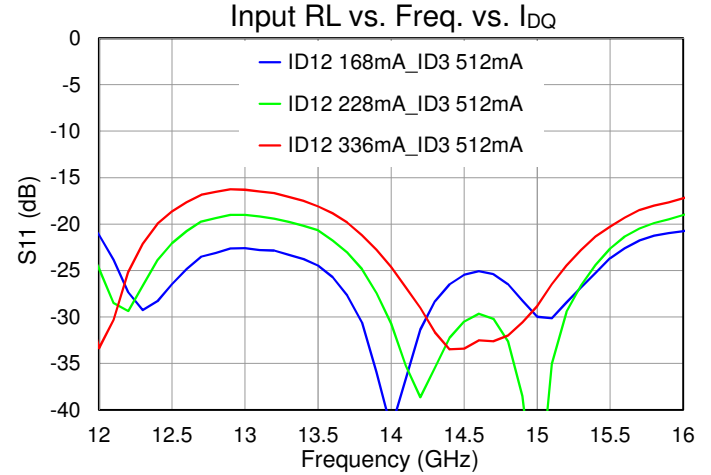
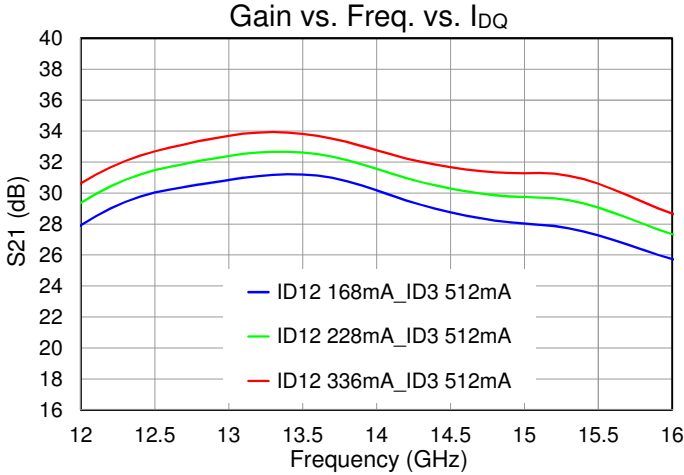

Thermal and Reliability Information

Parameter	Test Conditions	Value	Units
Thermal Resistance, θ_{JC} ⁽¹⁾	Quiescent, no RF	0.70	$^{\circ}\text{C}/\text{W}$
Channel Temperature, T_{CH} ⁽²⁾	$T_{BASE} = 85^{\circ}\text{C}$, $V_D = 24\text{ V}$, $I_{D12} = 168\text{ mA}$, $I_{D3} = 512\text{ mA}$ $P_{DISS} = 16.3\text{ W}$	96	$^{\circ}\text{C}$
Thermal Resistance, θ_{JC} ⁽¹⁾	For 13.75 – 14.5 GHz: $P_{IN} = 25\text{ dBm}$, $T_{BASE} = 85^{\circ}\text{C}$, CW, $V_D = 24\text{ V}$, $I_{D12} = 168\text{ mA}$, $I_{D3} = 512\text{ mA}$, Freq = 14 GHz, I_{D_DRIVE} Total = 5560 mA, $P_{OUT} = 46.2\text{ dBm}$ $P_{DISS} = 91.9\text{ W}$	0.73	$^{\circ}\text{C}/\text{W}$
Channel Temperature, T_{CH} ⁽²⁾		152	$^{\circ}\text{C}$
Thermal Resistance, θ_{JC} ⁽¹⁾	For 13.75 – 14.5 GHz $P_{IN} = 25\text{ dBm}$, $T_{BASE} = 85^{\circ}\text{C}$, CW, $V_D = 24\text{ V}$, $I_{D12} = 228\text{ mA}$, $I_{D3} = 512\text{ mA}$, Freq = 14 GHz, I_{D_DRIVE} Total = 5680 mA, $P_{OUT} = 46.3\text{ dBm}$ $P_{DISS} = 93.7\text{ W}$	0.73	$^{\circ}\text{C}/\text{W}$
Channel Temperature, T_{CH} ⁽²⁾		153	$^{\circ}\text{C}$
Thermal Resistance, θ_{JC} ⁽¹⁾	For extended 12.75 – 15.35 GHz: $P_{IN} = 25\text{ dBm}$, $T_{BASE} = 85^{\circ}\text{C}$, CW, $V_D = 24\text{ V}$, $I_{D12} = 168\text{ mA}$, $I_{D3} = 512\text{ mA}$, Freq = 13 GHz, I_{D_DRIVE} Total = 5960 mA, $P_{OUT} = 46\text{ dBm}$ $P_{DISS} = 104\text{ W}$	0.74	$^{\circ}\text{C}/\text{W}$
Channel Temperature, T_{CH} ⁽²⁾		162	$^{\circ}\text{C}$
Thermal Resistance, θ_{JC} ⁽¹⁾	For extended 12.75 – 15.35 GHz: $P_{IN} = 25\text{ dBm}$, $T_{BASE} = 85^{\circ}\text{C}$, CW, $V_D = 24\text{ V}$, $I_{D12} = 228\text{ mA}$, $I_{D3} = 512\text{ mA}$, Freq = 13 GHz, I_{D_DRIVE} Total = 6028 mA, $P_{OUT} = 46\text{ dBm}$ $P_{DISS} = 105\text{ W}$	0.74	$^{\circ}\text{C}/\text{W}$
Channel Temperature, T_{CH} ⁽²⁾		163	$^{\circ}\text{C}$
Thermal Resistance, θ_{JC} ⁽¹⁾	For 13.75 – 14.5 GHz: $P_{IN} = 29\text{ dBm}$, $T_{BASE} = 85^{\circ}\text{C}$, CW, $V_D = 24\text{ V}$, $I_{D12} = 168\text{ mA}$, $I_{D3} = 512\text{ mA}$, Freq = 14 GHz, I_{D_DRIVE} Total = 6925 mA, $P_{OUT} = 47.4\text{ dBm}$ $P_{DISS} = 112\text{ W}$	0.75	$^{\circ}\text{C}/\text{W}$
Channel Temperature, T_{CH} ⁽²⁾		169	$^{\circ}\text{C}$
Thermal Resistance, θ_{JC} ⁽¹⁾	For extended 12.75 – 15.35 GHz: $P_{IN} = 29\text{ dBm}$, $T_{BASE} = 85^{\circ}\text{C}$, CW, $V_D = 24\text{ V}$, $I_{D12} = 168\text{ mA}$, $I_{D3} = 512\text{ mA}$, Freq = 13 GHz, I_{D_DRIVE} Total = 7275 mA, $P_{OUT} = 47.2\text{ dBm}$ $P_{DISS} = 123\text{ W}$	0.76	$^{\circ}\text{C}/\text{W}$
Channel Temperature, T_{CH} ⁽²⁾		179	$^{\circ}\text{C}$

Notes:

1. Thermal resistance determined to the back QPA1314T
2. Channel temperature indicated is an IR scan equivalent temperature. Thermal resistance is calculated using this value. Additional information can be found in the Qorvo Applications Note "GaN Device TCHMAX Theta-JC and Reliability Estimates," located here <https://www.qorvo.com/products/d/da006480>

Dissipated Power and Maximum Gate Current

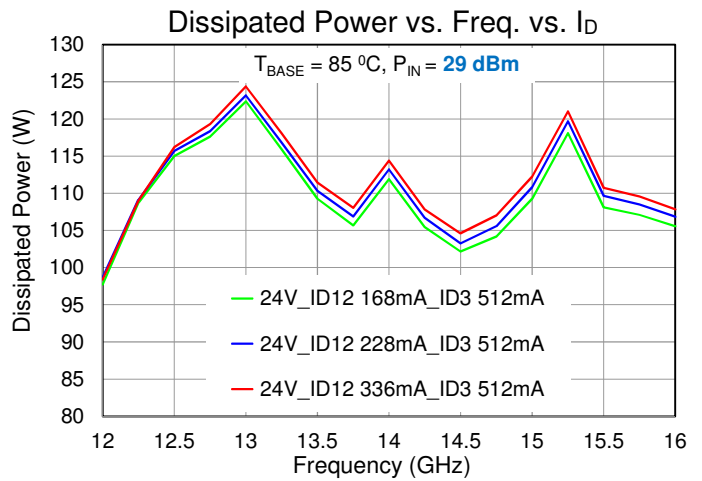
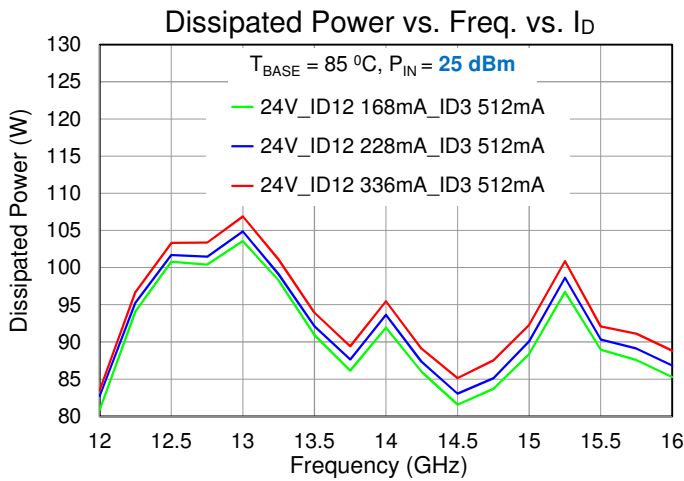

Test conditions, unless otherwise noted: CW, $V_D = 24\text{ V}$, $I_{D12} = 168, 228\text{ mA}$, $I_{D3} = 512\text{ mA}$, $P_{IN} = 25, 29\text{ dBm}$, $T_{BASE} = +85\text{ }^{\circ}\text{C}$, T_{BASE} is backside of QPA1314T

Maximum Gate Current

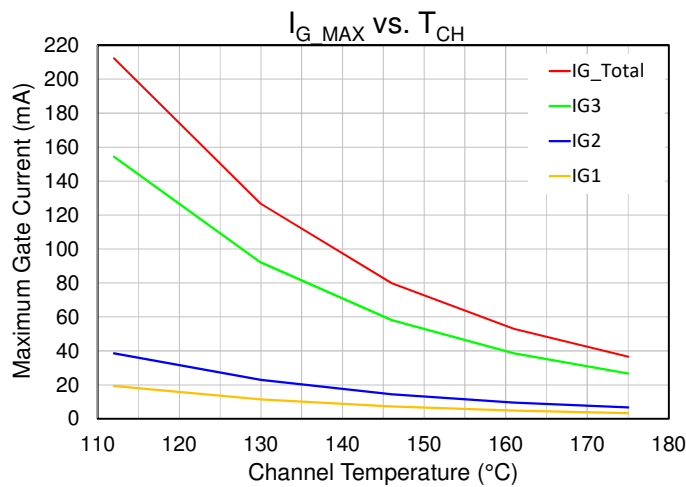

Channel Temperature is an IR scan equivalent

Applications Information

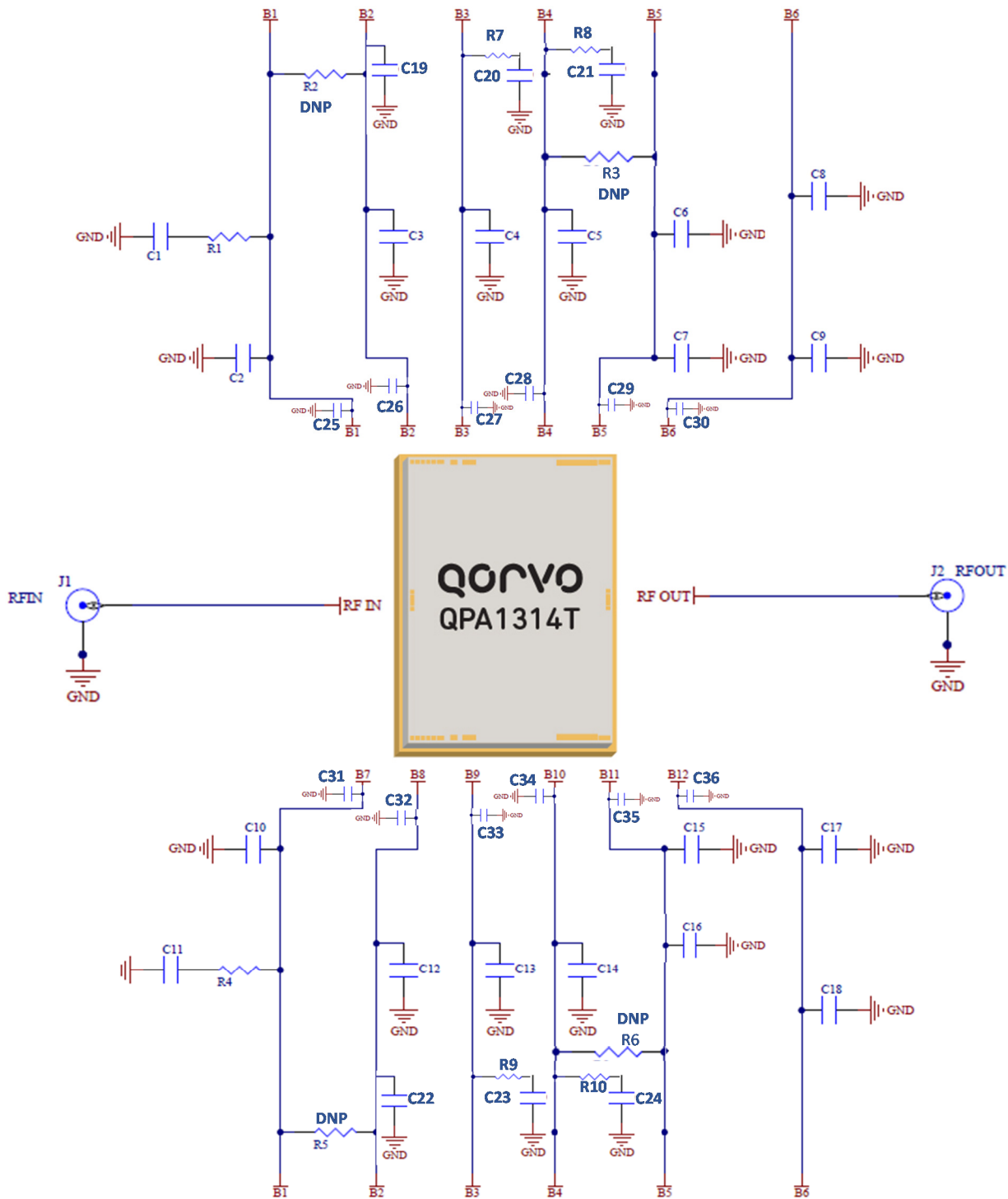

DC can be applied from top, or bottom, or both sides of the dies;
External bypassing required on both sides

Evaluation Board (EVB) Layout

EVB as shown is for the QPA1314D (bare die) which also is used for QPA1314T

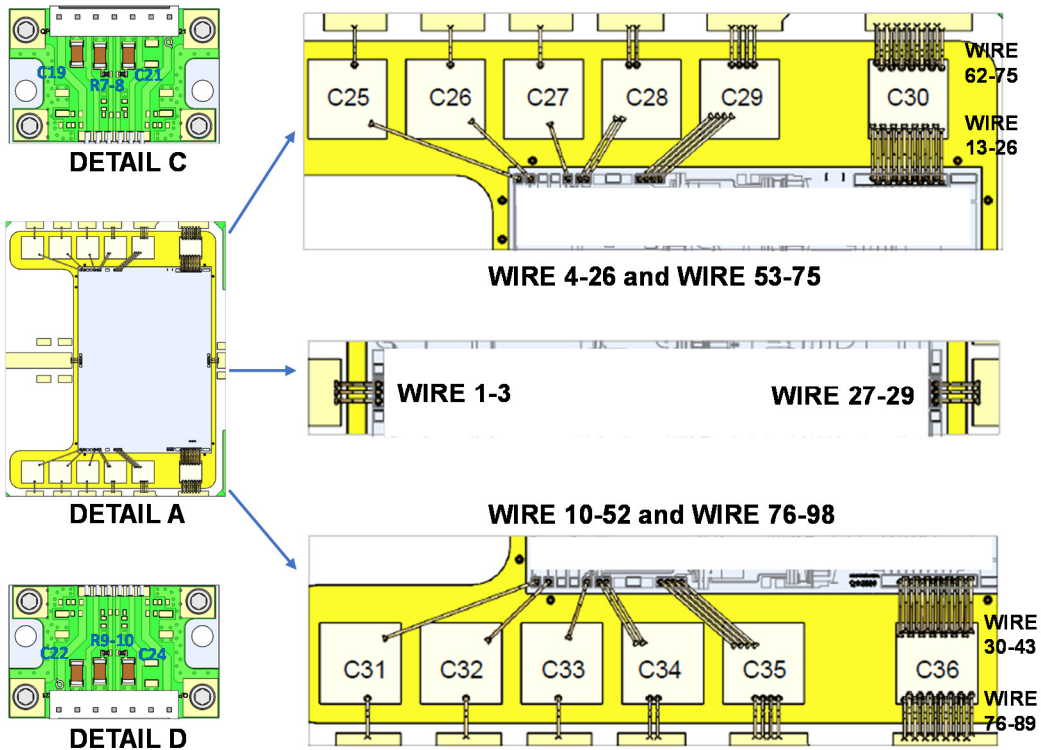
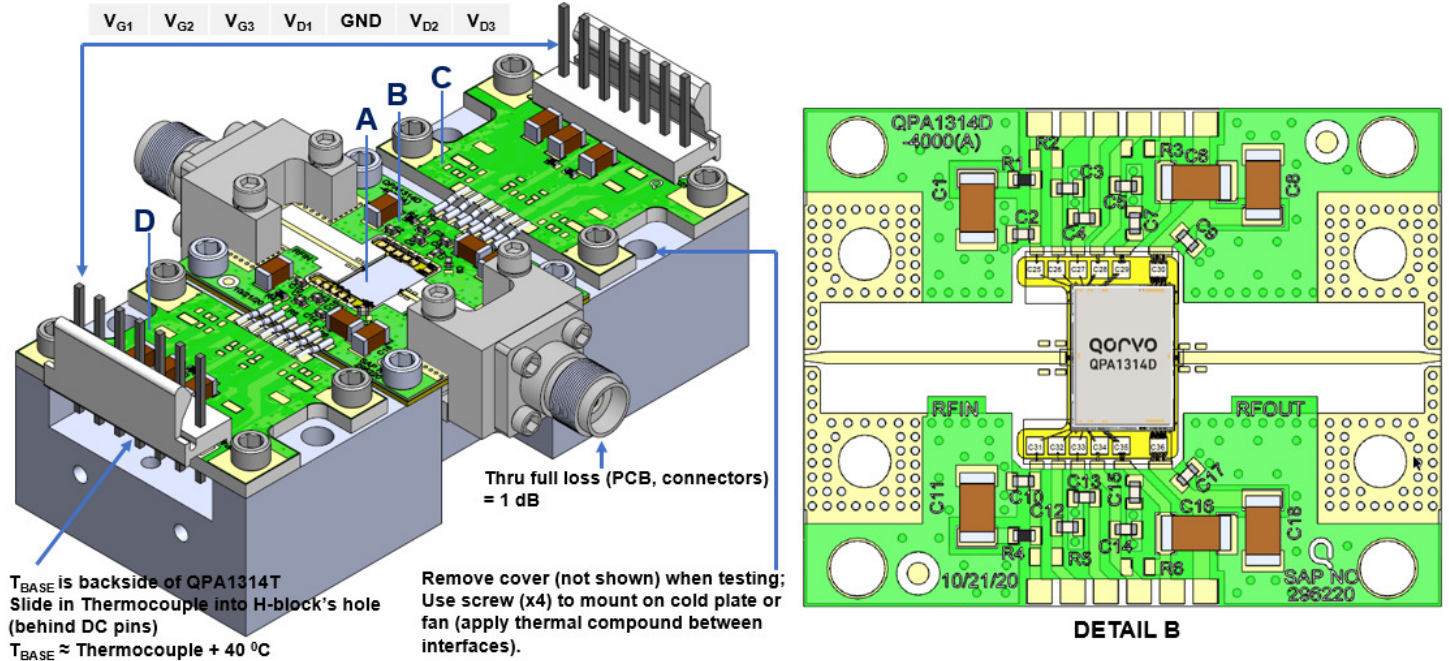

Bill of Materials

Reference Des.	Qty	Value	Description	Part Number
C1, C6, C8, C11, C16, C18 – C24	12	10 uF	CAP, 10uF, 20%, 50V, 20%, X5R, 1206	
C2 – C5, C7, C9 – 10, C12 – C15, C17	12	0.01 uF	CAP, 0.01uF, ±10%, 50V, X7R, 0402	
C25 – C36	12	10 nF	CAP, 10nF, ±15%, 30V, SLC, 0303	
R1, R4, R7 – R10	6	0 Ω	RES, 0 Ohm, JMPR, 0402	
PCB_MMIC	1		PCB for MMIC, Taconics RF-35HTC 0.01", 0.5oz Ni/Pd/Au plating both sides, total thickness 0.14"	Qorvo, Custom
PCB,_Bias	2		PCB for DC Bias	Qorvo, Custom
H1, H2	2		CONN, HDR, Male-vert, 7 PIN, 1 RAW, MTA	
J1, J2	2		Connector, RF 2.9mm, F, Pin 0.005, Diel 0.029	Southwest Microwave 1092-01A-5
CP	1		Carrier Plate, CuMo, 0.9 x 1.15 x 0.02T	Qorvo, Custom
H-Block	1		H-Block, Copper C110, 1.14 x 2.49 x 0.59T	Qorvo, Custom
S1 – S4	4		Screw, Cap, Socket Head, 2-56X1/8"	
S5 – S12	8		Screw, Cap, Socket Head, 2-56X3/16"	
AuSn			AuSn Solder preform	
Epoxy			Epoxy preform	
Ablebond			Epoxy, Ablebond 84-1LMI	
Solder			Paste, solder, Syntech, Sn63/Pb37	
TC			Thermal Compound, Silver 5GR	Artic Silver 5 AS5-5G

Bias-Up Procedure

1. Set I_D limit to 9.5 A, I_G limit to 15 mA
2. Set V_{G12} to -5.0 V; V_{G3} to -5.0 V
3. Set V_D +24 V. Ensure $I_{DQ} \sim 0$ mA
4. Adjust V_{G12} more positive until $I_{D12} = 168$ mA;
Adjust V_{G3} more positive until $I_{D3} = 512$ mA;
 $V_G \approx -2.3$ V +/- 0.6V typical range
5. Apply RF signal

Bias-Down Procedure

1. Turn off RF signal
2. Reduce V_G to -5.0 V. Ensure $I_{DQ} \sim 0$ mA
3. Set V_D to 0 V
4. Turn off V_D supply
5. Turn off V_G supply

If using three (3) bias supplies for V_D , V_{G12} , V_{G3} : combining all three V_D together, combining V_{G1} and V_{G2} as V_{G12} , adjusting V_{G12} to achieve $I_D = I_{D12}$, then adjusting V_{G3} to achieve I_{D3} where $I_D = I_{D12} + I_{D3}$

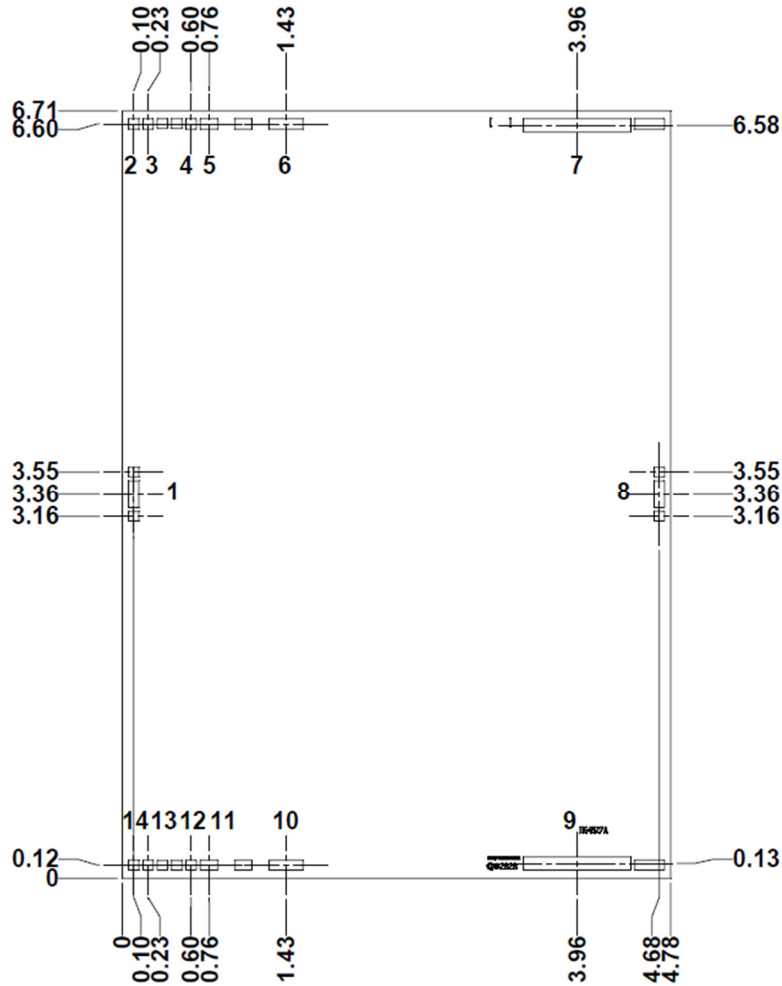
Mechanical Information (MMIC Only)

Dimensions: mm; Thickness: 0.10 mm; Die x, y size tolerance: ± 0.050; Ground is backside of die

Bond Pad Description

Pad No.	Symbol	Pad Size (mm)	Description
1	RF _{IN}	0.09 x 0.24	RF Input. Matched to 50 Ω, DC blocked, DC shorted to ground
2, 14	V _{G1}	0.09 x 0.09	Gate voltage for stage 1*
3, 13	V _{G2}	0.09 x 0.09	Gate voltage for stage 2*
4, 12	V _{G3}	0.09 x 0.09	Gate voltage for stage 3*
5, 11	V _{D1}	0.15 x 0.09	Drain voltage for stage 1*
6, 10	V _{D2}	0.30 x 0.09	Drain voltage for stage 2*
7, 9	V _{D4}	0.94 x 0.12	Drain voltage for stage 3*
8	RF _{OUT}	0.09 x 0.24	RF Output. Matched to 50 Ω, DC blocked, DC shorted to ground

* External bypassing required; refer to page 26 for recommendation

Mechanical Information (MMIC on Tab)

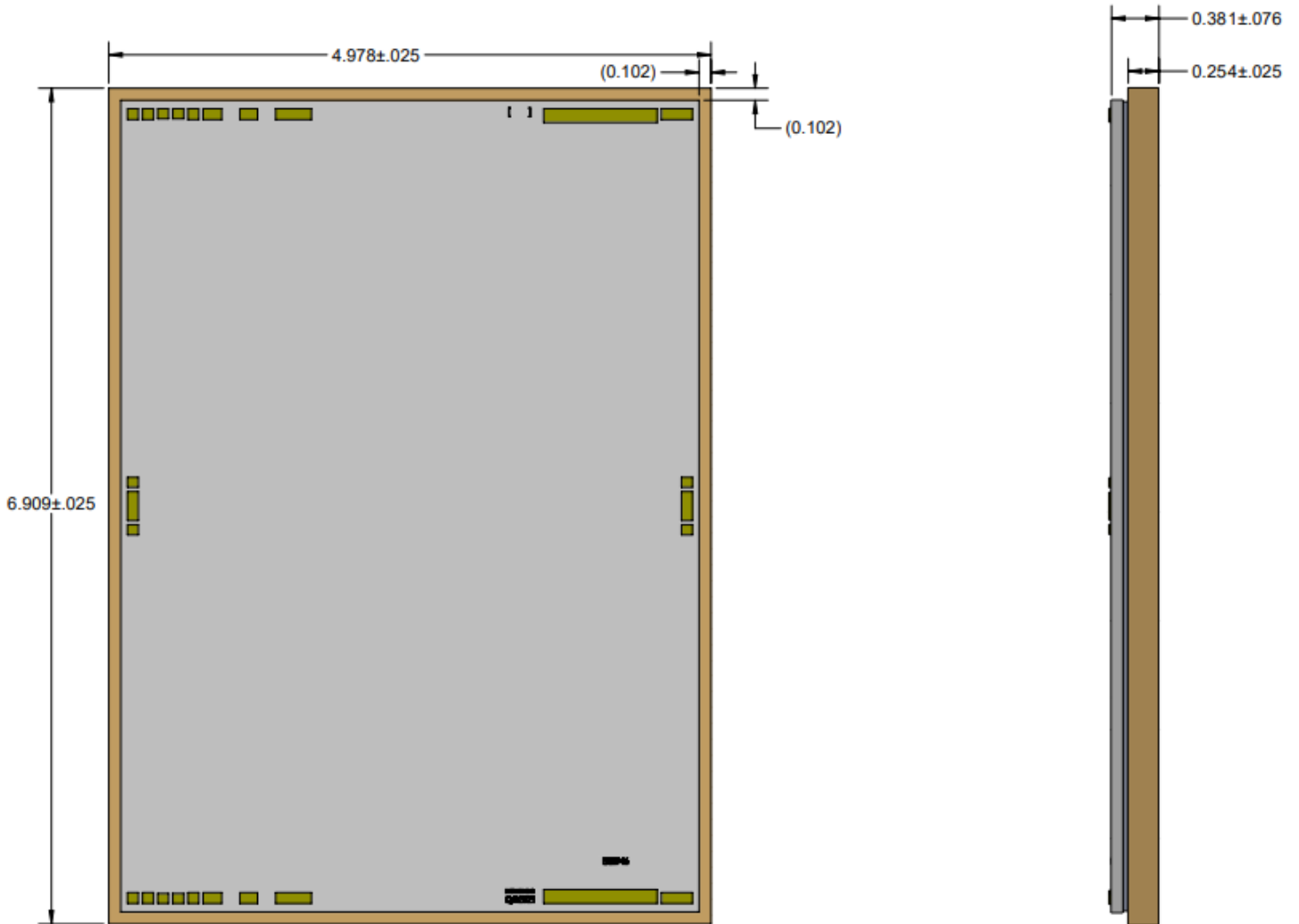

Dimensions: mm
 Tab material: CuMo
 Tab plating: Au

Assembly Notes

Component placement and adhesive attachment assembly notes:

- Vacuum pencils and/or vacuum collets are the preferred method of pick up.
- Air bridges must be avoided during placement.
- The force impact is critical during auto placement.

Interconnect process assembly notes:

- Thermosonic ball bonding is the preferred interconnect technique.
- Force, time, and ultrasonic are critical parameters.
- Aluminum wire should not be used.
- Devices with small pad sizes should be bonded with 0.0007-inch wire.

Handling Precautions

Parameter	Rating	Standard
ESD – Human Body Model (HBM)	1C	ANSI/ESD/JEDEC JS-001



Caution!

ESD-Sensitive Device

RoHS Compliance

This part is compliant with 2011/65/EU RoHS directive (Restrictions on the Use of Certain Hazardous Substances in Electrical and Electronic Equipment) as amended by Directive 2015/863/EU.

This product also has the following attributes:

- Lead Free
- Halogen Free (Chlorine, Bromine)
- Antimony Free
- TBBP-A (C₁₅H₁₂Br₄O₂) Free
- SVHC Free
- PFOS Free

Contact Information

For the latest specifications, additional product information, worldwide sales and distribution locations:

Web: www.qorvo.com

Tel: 1-844-890-8163

Email: customer.support@qorvo.com

Important Notice

The information contained herein is believed to be reliable; however, Qorvo makes no warranties regarding the information contained herein and assumes no responsibility or liability whatsoever for the use of the information contained herein. All information contained herein is subject to change without notice. Customers should obtain and verify the latest relevant information before placing orders for Qorvo products. The information contained herein or any use of such information does not grant, explicitly or implicitly, to any party any patent rights, licenses, or any other intellectual property rights, whether with regard to such information itself or anything described by such information. **THIS INFORMATION DOES NOT CONSTITUTE A WARRANTY WITH RESPECT TO THE PRODUCTS DESCRIBED HEREIN, AND QORVO HEREBY DISCLAIMS ANY AND ALL WARRANTIES WITH RESPECT TO SUCH PRODUCTS WHETHER EXPRESS OR IMPLIED BY LAW, COURSE OF DEALING, COURSE OF PERFORMANCE, USAGE OF TRADE OR OTHERWISE, INCLUDING THE IMPLIED WARRANTIES OF MERCHANTABILITY AND FITNESS FOR A PARTICULAR PURPOSE.**

Without limiting the generality of the foregoing, Qorvo products are not warranted or authorized for use as critical components in medical, life-saving, or life-sustaining applications, or other applications where a failure would reasonably be expected to cause severe personal injury or death.

© 2022 Qorvo US, Inc. All rights reserved. This document is subject to copyright laws in various jurisdictions worldwide and may not be reproduced or distributed, in whole or in part, without the express written consent of Qorvo US, Inc.