

Applications

- Satellite Communications
- Point-to-Point Communications

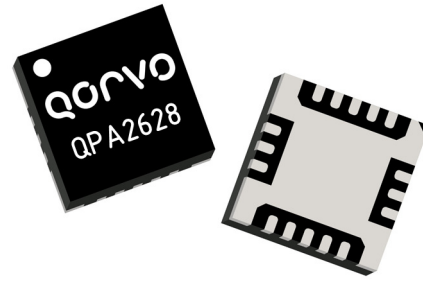

Product Features

- Frequency Range: 22 – 32 GHz
- Noise Figure: 1.6 dB (typical)
- Small Signal Gain: 23 dB (typical)
- P1dB: 19 dBm (typical)
- IM3: –54 dBc (Pout=0 dBm/tone) (typical)
- Bias: $V_D = 3.5$ V, $I_{DQ} = 90$ mA, $V_G = -0.46$ V (typical)
- Plastic Overmolded Package
- Package Dimensions: 4.0 x 4.0 x 0.85 mm

Functional Block Diagram

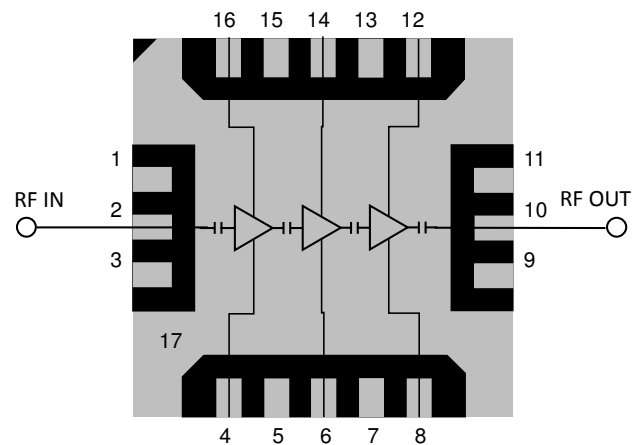

General Description

Qorvo's QPA2628 is a packaged, high-performance, low noise amplifier fabricated on Qorvo's production 90nm pHEMT (QPHT09) process. Covering 22 – 32 GHz, the QPA2628 provides 23 dB small signal gain and P1dB of 19 dBm, while supporting a noise figure of 1.6 dB and IM3 levels of –54 dBc (at Pout=0 dBm/tone).

Packaged in a small 4 mm x 4 mm plastic overmold QFN, the QPA2628 is matched to 50 ohms with integrated DC blocking caps on both I/O ports for easy handling and simple system integration.

The QPA2628 high performance and ease of handling makes it ideal for satellite and point to point communication systems.

Lead-free and RoHS compliant.

Evaluation boards are available upon request.

Pad Configuration

Pad No.	Label
1, 3, 9, 11, 17 (slug)	GND
2	RF Input
4	VG1
6	VG2
8	VG3
10	RF Output
12	VD3
14	VD2
16	VD1
5, 7, 13, 15	N/C

Ordering Information

Part	ECCN	Description
QPA2628	3A001.b.2.d	22 – 32 GHz Low Noise Amplifier

Absolute Maximum Ratings

Parameter	Value
Drain Voltage (V_D)	5.0 V
Drain Current ($I_{D1}/I_{D2}/I_{D3}$)	45/45/160 mA
Gate Voltage Range	0 to -1.5 V
Gate Current ($I_{G1}/I_{G2}/I_{G3}$ at 125 °C)	5.0/5.0/6.6 mA
RF Input Power (50 Ω , 85 °C)	20 dBm
Channel Temperature, T_{CH}	175 °C
Mounting Temperature (30 seconds)	260 °C
Storage Temperature	-55 to 150 °C

Operation of this device outside the parameter ranges given above may cause permanent damage. These are stress ratings only, and functional operation of the device at these conditions is not implied.

Recommended Operating Conditions

Parameter	Value
Drain Voltage	3.5 V
Drain Current (quiescent, I_{DQ})	90 mA
Drain Current (I_D , Low noise / P_{SAT})	90 / 175 mA
Gate Voltage (typical)	-0.46 V
Operating Temperature Range	-40 to 85 °C

Electrical specifications are measured at specified test conditions. Specifications are not guaranteed over all recommended operating conditions.

Electrical Specifications

Test conditions, unless otherwise noted: 25 °C, $V_D = 3.5$ V, $I_{DQ} = 90$ mA. Data de-embedded to device reference plane.

Parameter	Min	Typical	Max	Units
Frequency	22		32	GHz
Small Signal Gain		23		dB
Noise Figure		1.6		dB
1-dB Compression Point		19		dBm
Input Return Loss		11		dB
Output Return Loss		16		dB
3 RD Order Intermodulation level ($P_{out}=0$ dBm/tone)		-54		dBc
Output TOI ($P_{out}=0$ dBm/tone)		27		dBm
Gain Temperature Coefficient		-0.013		dBm/°C

Thermal and Reliability Information

Parameter	Test Conditions	Value	Units
Thermal Resistance (θ_{JC}) ⁽¹⁾	$T_{base} = 85^\circ\text{C}$, $V_D = 3.5\text{ V}$, $I_{DQ} = 90\text{ mA}$ Quiescent/Small Signal operation $P_{DISS} = 0.315\text{ W}$	65.1	$^\circ\text{C/W}$
Channel Temperature (T_{CH})		105.5	$^\circ\text{C}$
Median Lifetime (T_M)		1.236E08	Hrs

Notes:

- Thermal resistance is measured to back of the package.

Median Lifetime

Test Conditions: $V_D = 4\text{ V}$
 Failure Criteria = 10% reduction in I_{D_MAX}

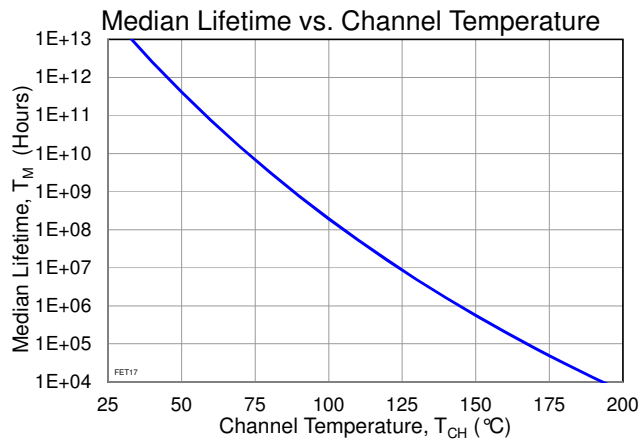

Typical Performance: Small Signal

Test conditions unless otherwise noted: Temp. = 25 °C, $V_D = 3.5$ V, $I_{DQ} = 90$ mA. Data de-embedded to device reference plane.

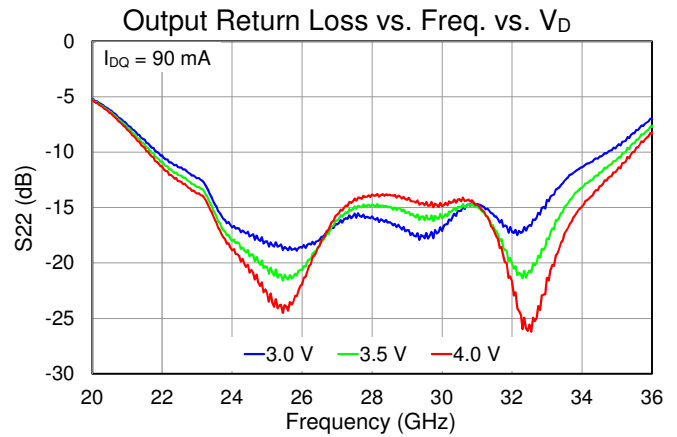
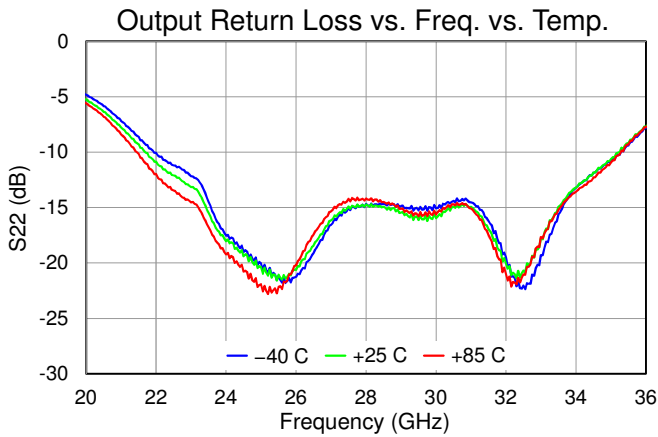
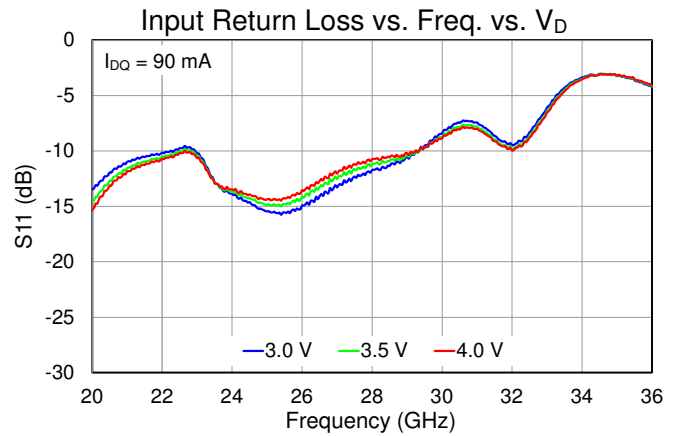
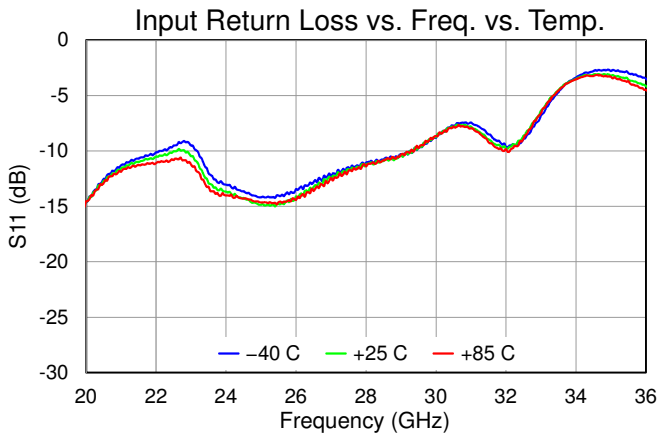
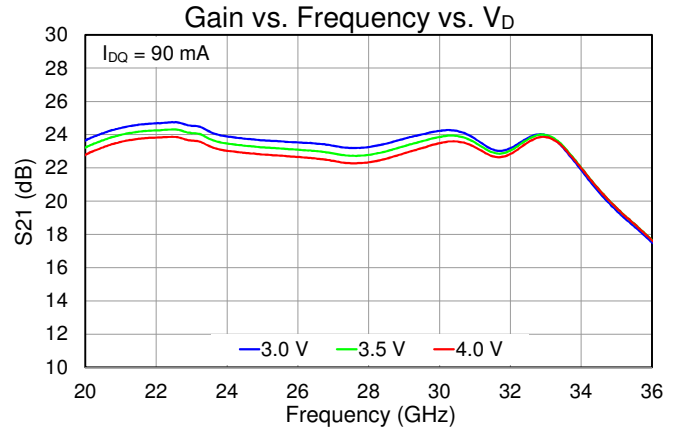
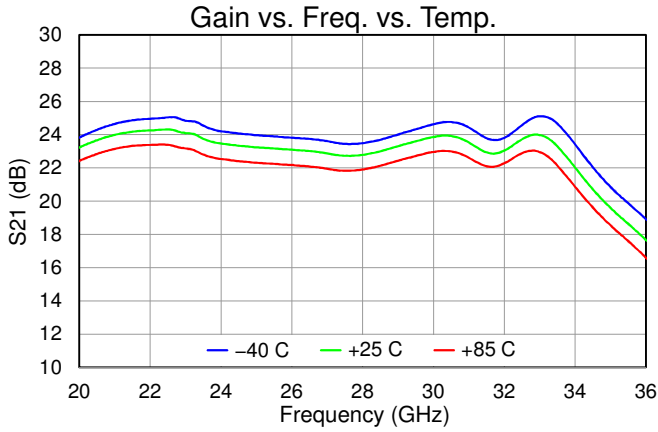

Typical Performance: Small Signal

Test conditions unless otherwise noted: Temp. = 25 °C, $V_D = 3.5$ V, $I_{DQ} = 90$ mA. Data de-embedded to device reference plane.

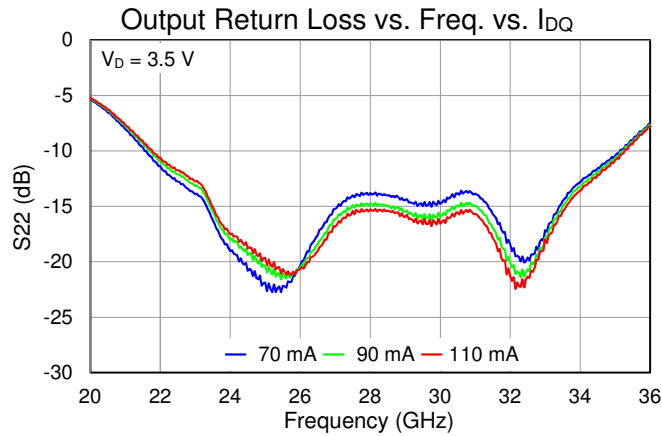
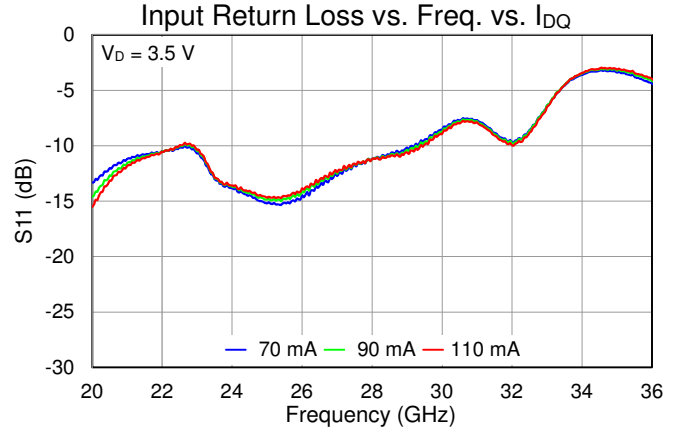
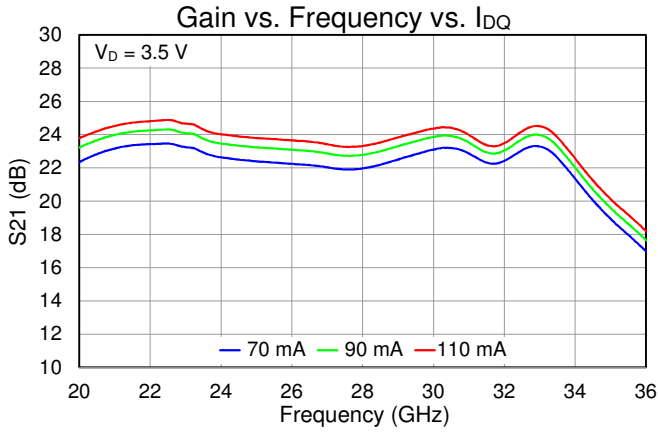

Typical Performance: Noise Figure

Test conditions unless otherwise noted: Temp. = 25 °C, $V_D = 3.5\text{ V}$, $I_{DQ} = 90\text{ mA}$. Data de-embedded to device reference plane.

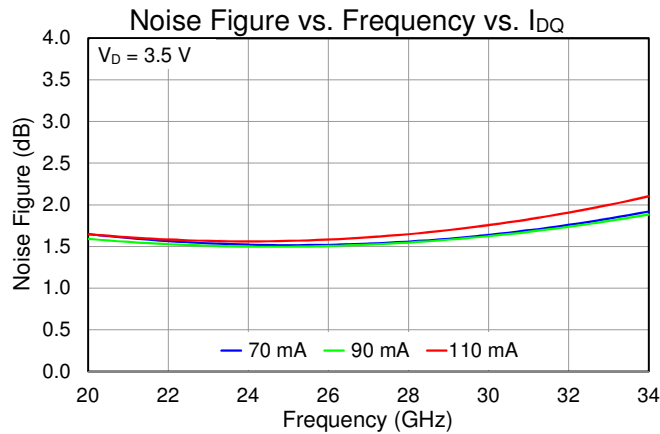
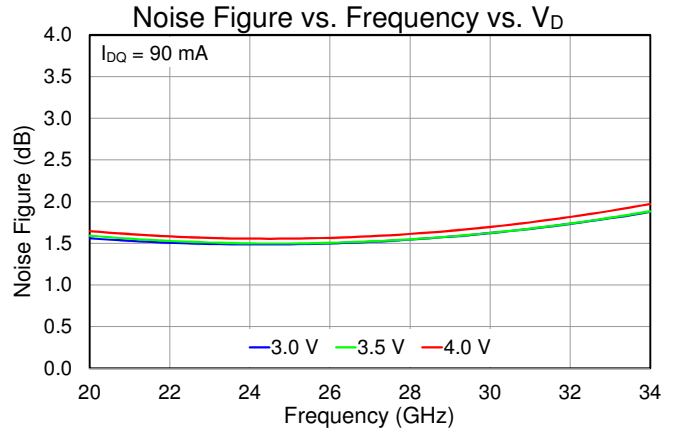
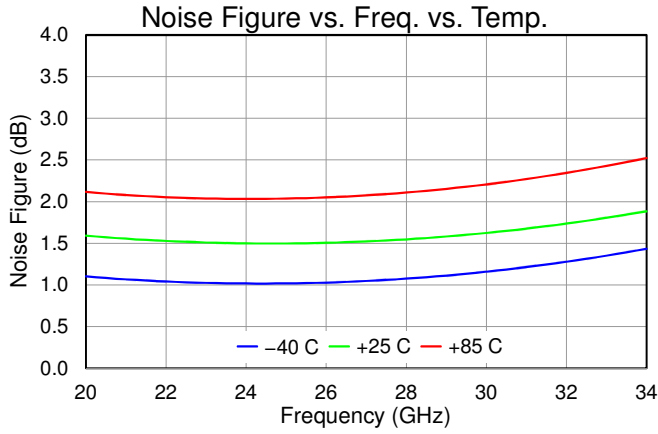

Typical Performance: Large Signal

Test conditions unless otherwise noted: Temp. = 25 °C, $V_D = 3.5\text{ V}$, $I_{DQ} = 90\text{ mA}$. Data de-embedded to device reference plane.

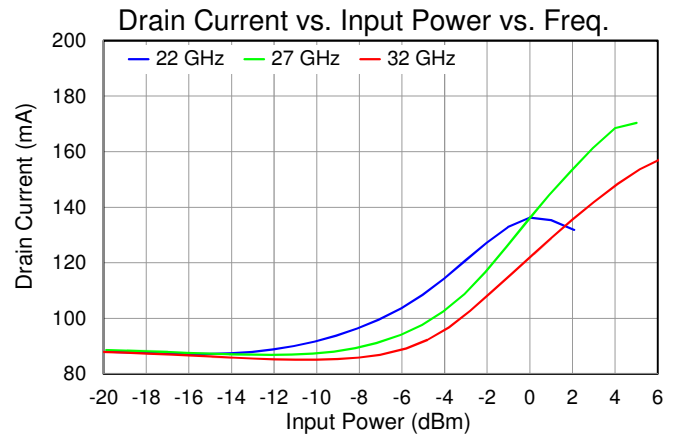
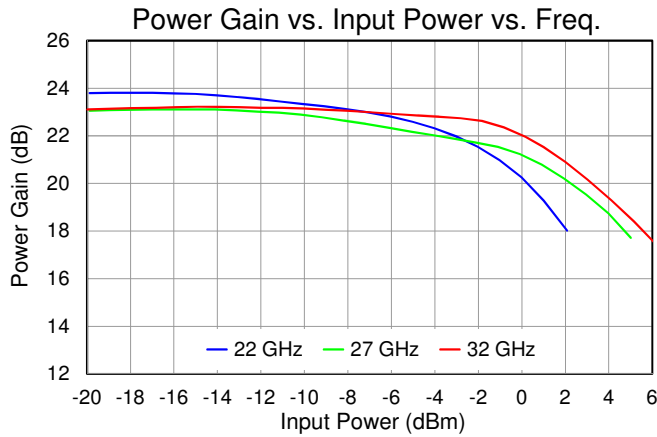
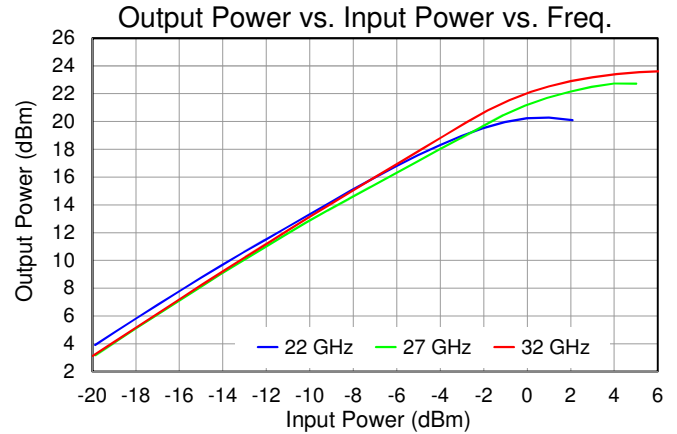
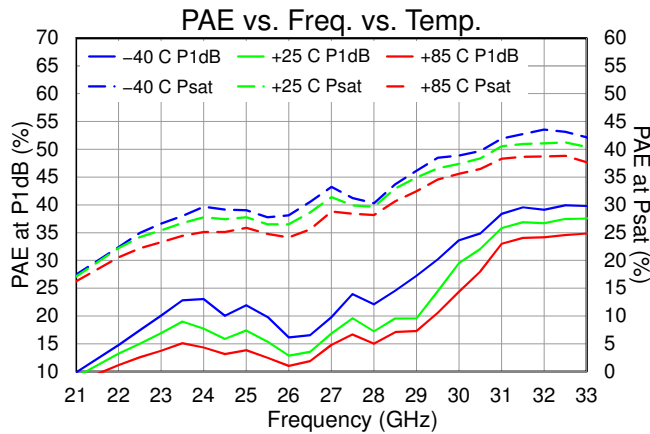
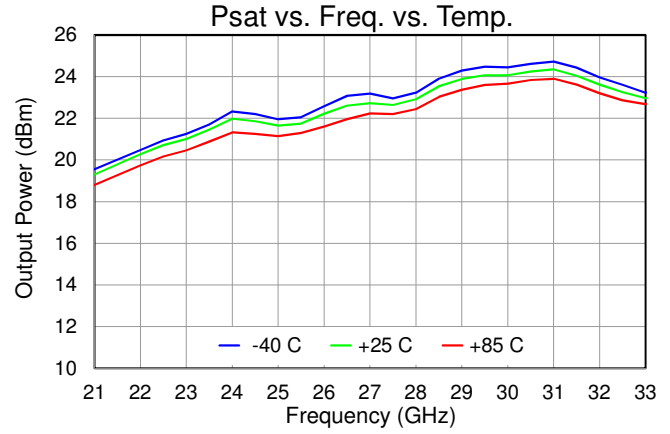
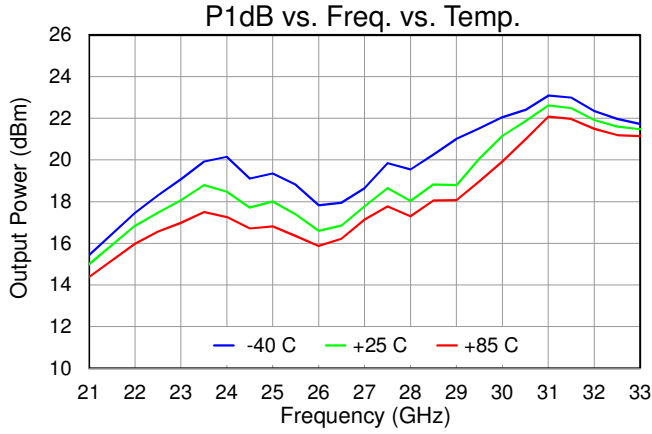

Typical Performance: Linearity

Test conditions unless otherwise noted: Temp. = 25 °C, $V_D = 3.5$ V, $I_{DQ} = 90$ mA. Data de-embedded to device reference plane.

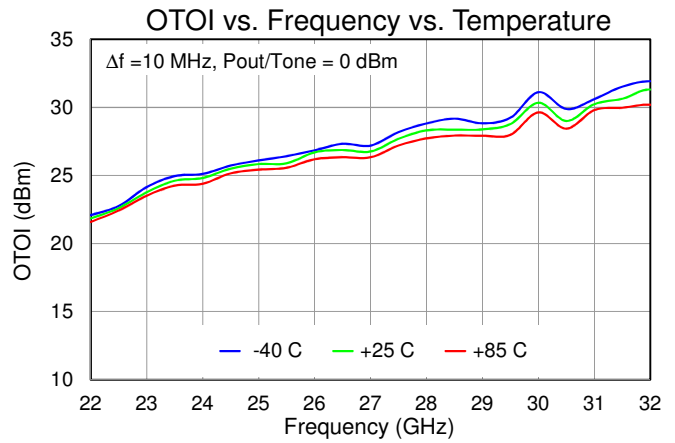
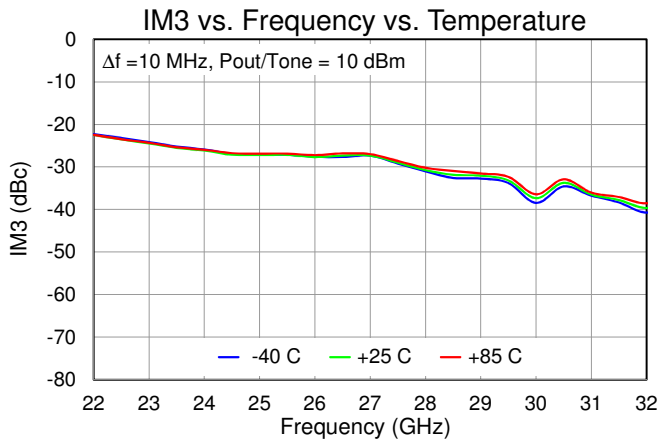
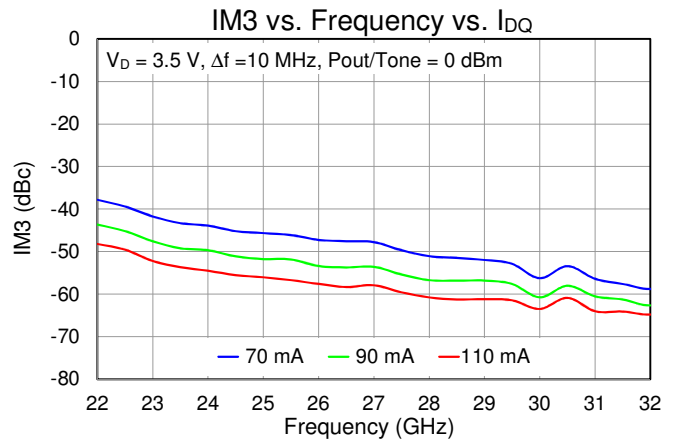
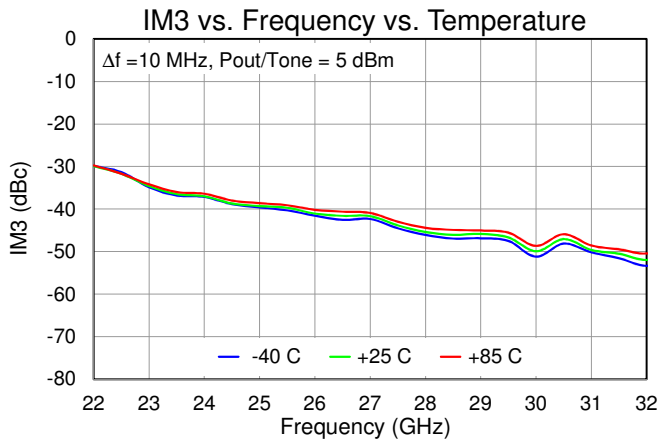
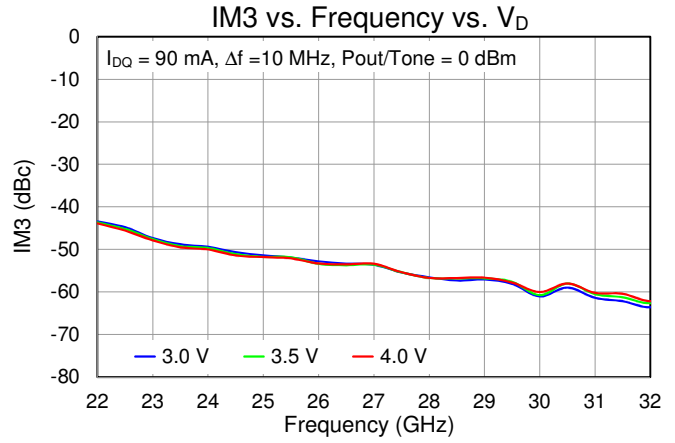
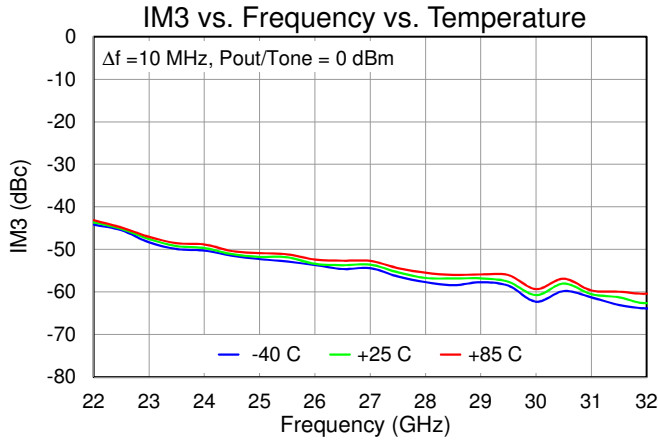

Typical Performance: Linearity

Test conditions unless otherwise noted: Temp. = 25 °C, $V_D = 3.5$ V, $I_{DQ} = 90$ mA. Data de-embedded to device reference plane.

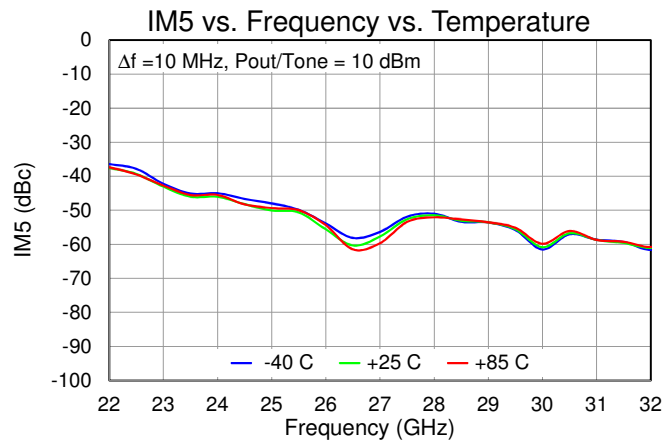
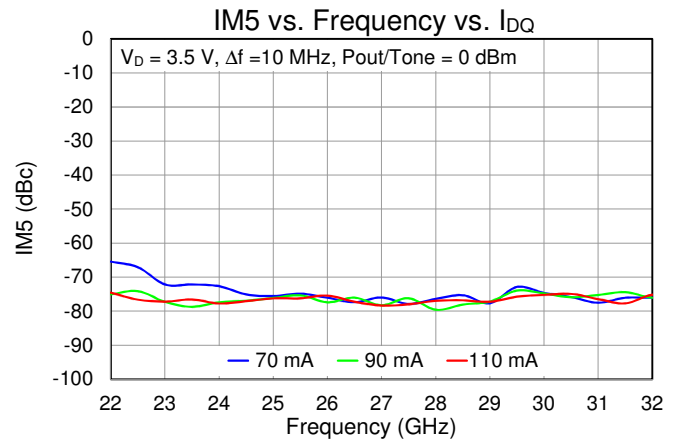
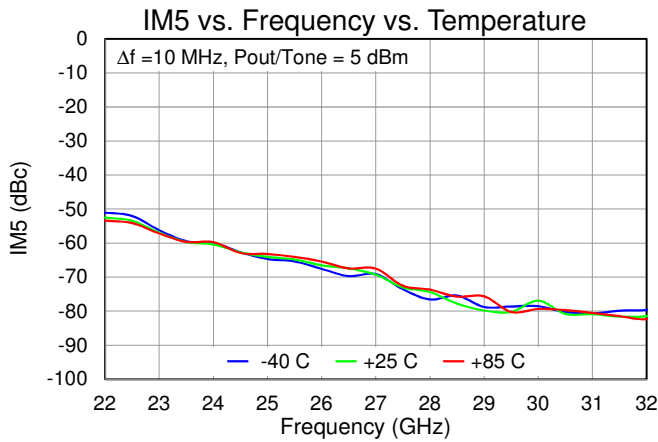
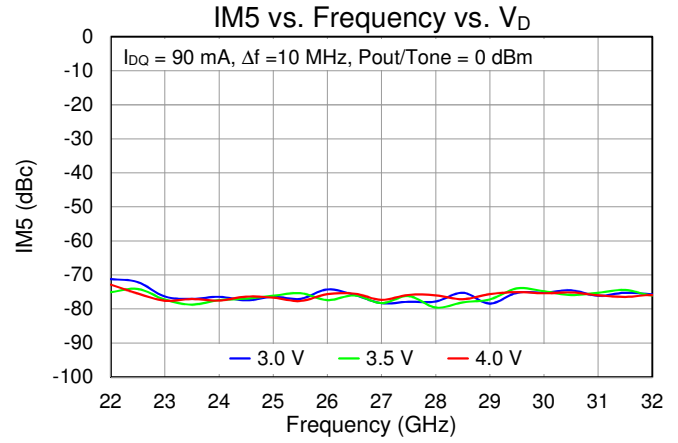
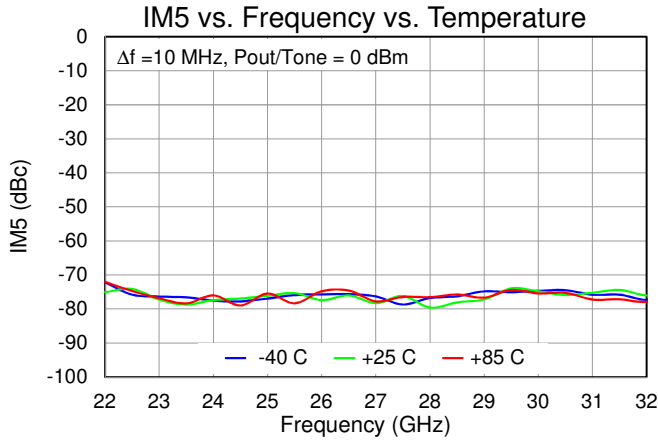

Application Circuit

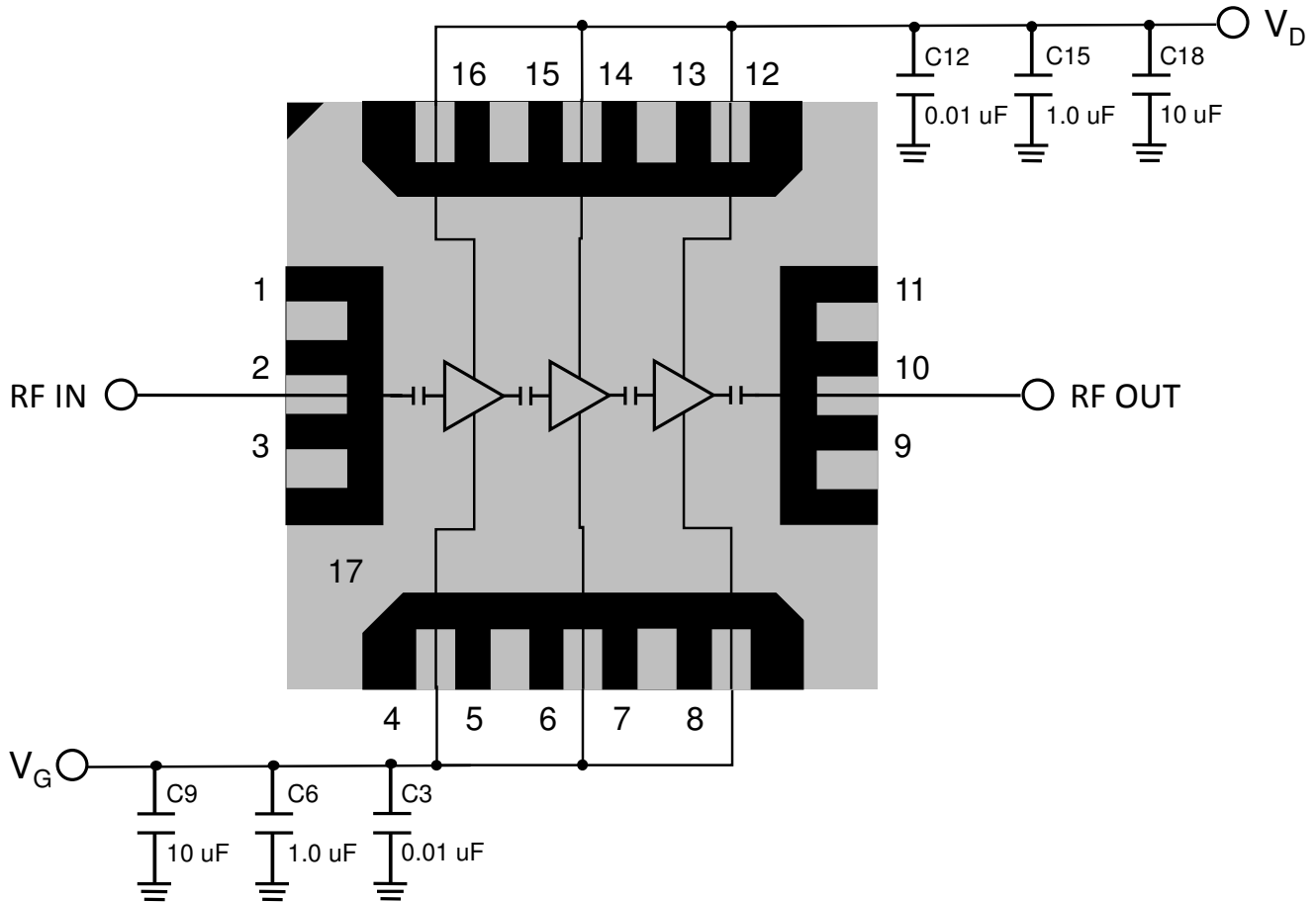

Bias-up Procedure

1. Set I_D limit to 200 mA, I_G limit to 10 mA
2. Set V_G to -1.5 V
3. Set V_D +3.5 V
4. Adjust V_G more positive until $I_{DQ} = 90$ mA ($V_G \sim -0.46$ V Typical)
5. Apply RF signal

Bias-down Procedure

1. Turn off RF signal
2. Reduce V_G to -1.5 V. Ensure $I_{DQ} \sim 0$ mA
3. Set V_D to 0V
4. Turn off V_D supply
5. Turn off V_G supply

Evaluation Board and Mounting Detail

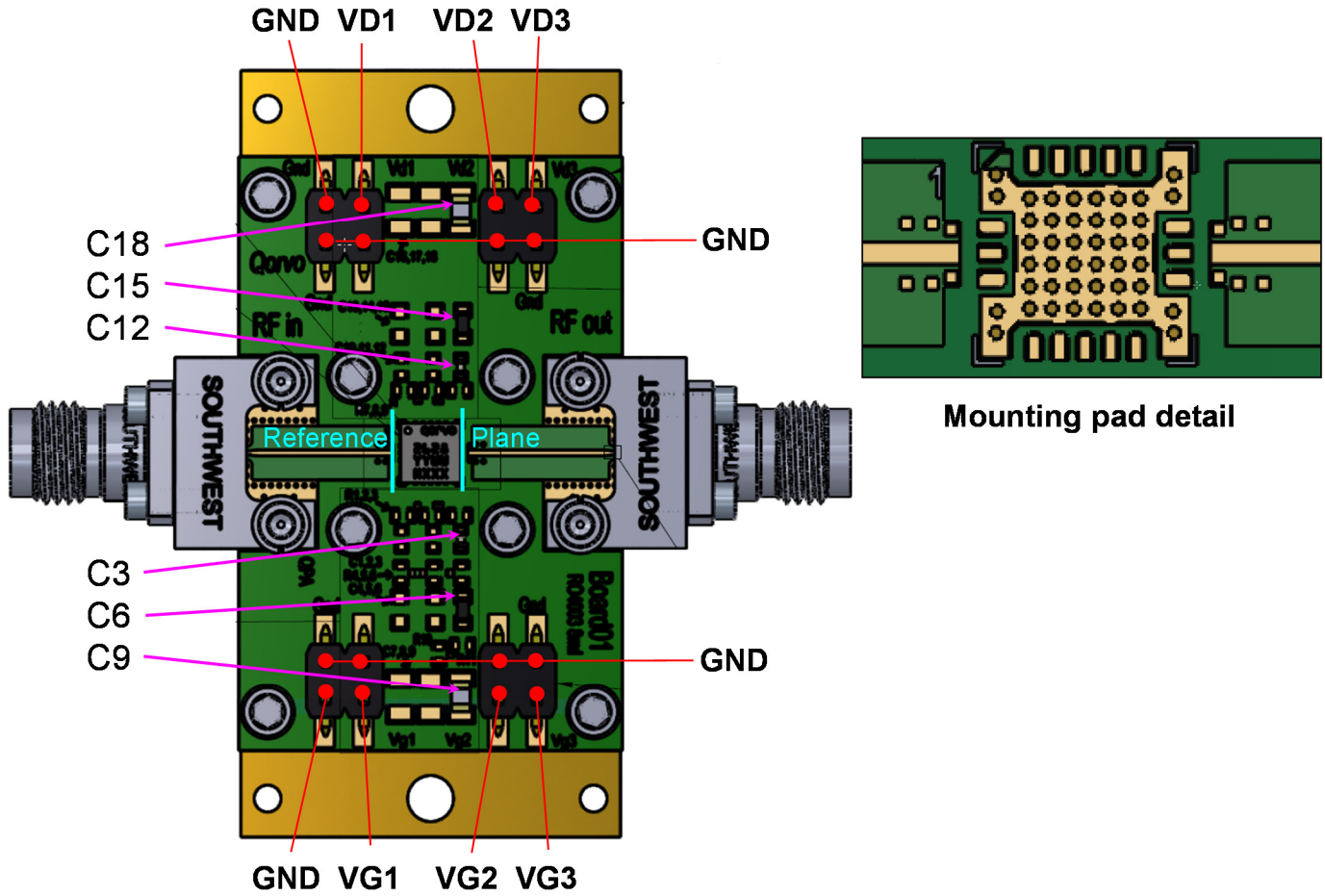

RF Layer is 0.008" thick Rogers Corp. RO4003C ($\epsilon_r = 3.35$). Metal layers are 0.5 oz. copper. The microstrip line at the connector interface is optimized for the Southwest Microwave end launch connector 1492-04A-5.

All data de-embedded to the device reference plane (shown).

Ref. Des.	Component	Value	Manuf.	Part Number
C3, C12	Surface Mount Cap.	CAP 0.01UF +/-10% 50V 0402 X7R ROHS	Various	
C6, C15	Surface Mount Cap.	CAP 1.0UF +/-10% 16V 0603 X7R ROHS	Various	
C9, C18	Surface Mount Cap.	CAP CER 10UF 10V X7R 10% 0805 TDK ROHS	Various	

Mechanical Drawing & Pad Description

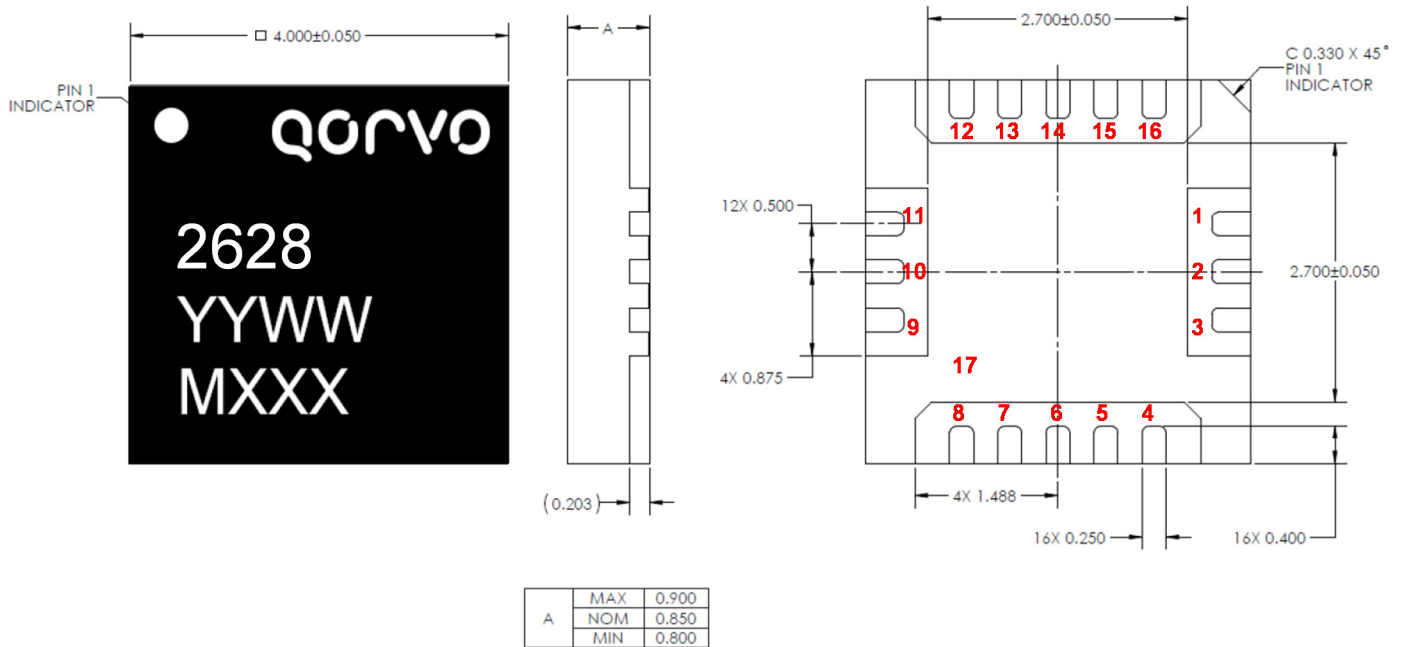

Dimensions in mm
 Part Marking:
 2628: Part Number
 YY = Part Assembly Year
 MM = Part Assembly Month
 MXXX = Batch ID

Pin Number	Label	Description
1, 3, 9, 11, 17 (slug)	GND	GROUND
2	RF Input	Matched to 50 ohms, DC blocked
4	VG1	Gate Voltage; bias network is required (V_G can be tied together at PCB)
6	VG2	Gate Voltage; bias network is required (V_G can be tied together at PCB)
8	VG3	Gate Voltage; bias network is required (V_G can be tied together at PCB)
10	RF Output	Matched to 50 ohms, DC blocked
12	VD3	Drain Voltage; bias network is required (V_D can be tied together at PCB)
14	VD2	Drain Voltage; bias network is required (V_D can be tied together at PCB)
16	VD1	Drain Voltage; bias network is required (V_D can be tied together at PCB)
5, 7, 13, 15	N/C	No internal connection. Recommend to GND at the PCB level

Recommended Soldering Temperature Profile

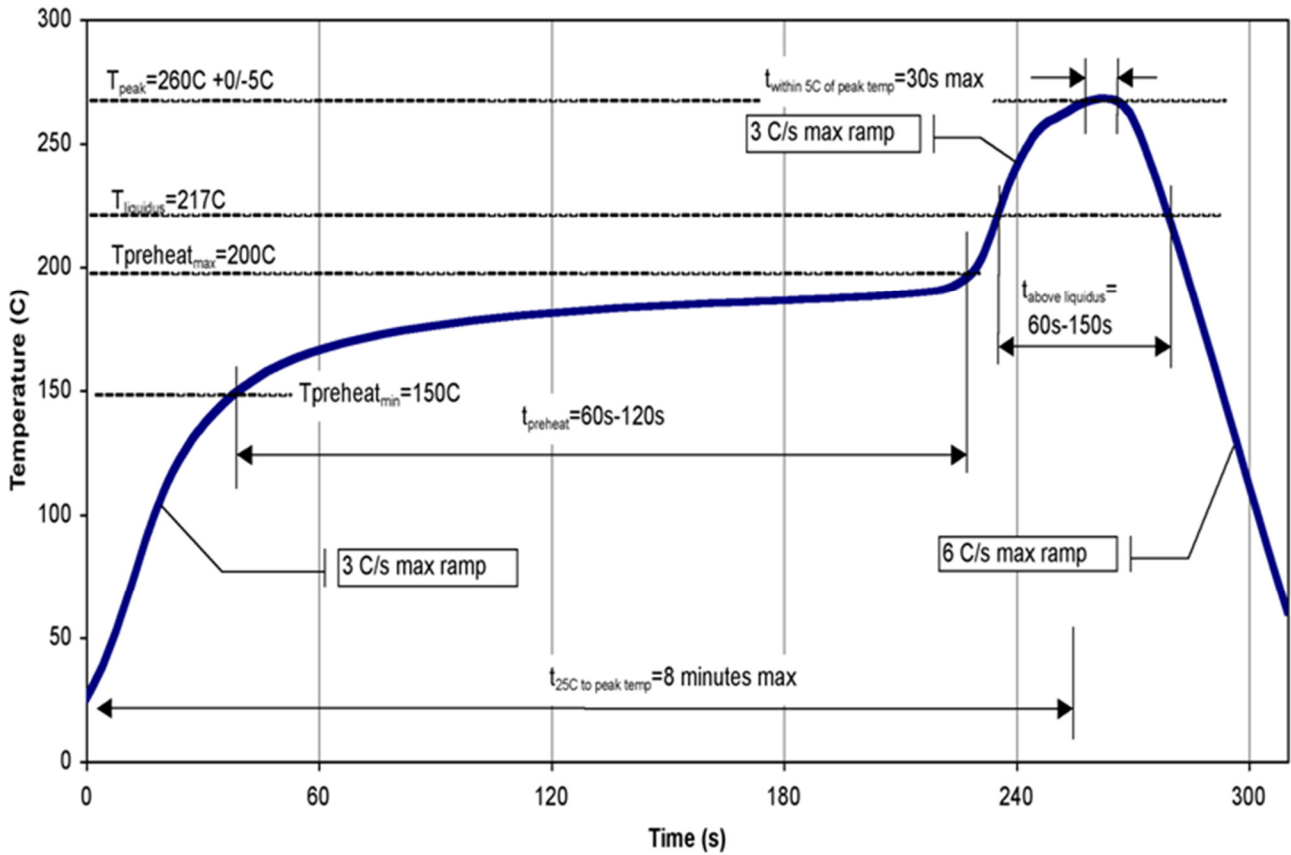

Product Compliance Information

ESD Sensitivity Ratings



Caution! ESD-Sensitive Device

ESD Rating: TBD
Value: TBD
Test: Human Body Model (HBM)
Standard: JEDEC Standard JESD22-A114

MSL Rating

Level 3 at 260 °C convection reflow
The part is rated Moisture Sensitivity Level 3
JEDEC standard IPC/JEDEC J-STD-020.

ECCN

US Department of Commerce: 3A001.b.2.d

Solderability

Compatible with the latest version of J-STD-020 Lead free solder, 260 °C.

RoHS–Compliance

This part is compliant with EU 2002/95/EC RoHS directive (Restrictions on the Use of Certain Hazardous Substances in Electrical and Electronic Equipment).

This product also has the following attributes:

- Lead Free
- Halogen Free (Chlorine, Bromine)
- Antimony Free
- TBBP-A (C₁₅H₁₂Br₄O₂) Free
- PFOS Free
- SVHC Free

Contact Information

For the latest specifications, additional product information, worldwide sales and distribution locations, and information about TriQuint:

Web: www.triquint.com
Email: info-sales@triquint.com

Tel: +1.972.994.8465
Fax: +1.972.994.8504

For technical questions and application information: **Email:** info-products@triquint.com

Important Notice

The information contained herein is believed to be reliable. TriQuint makes no warranties regarding the information contained herein. TriQuint assumes no responsibility or liability whatsoever for any of the information contained herein. TriQuint assumes no responsibility or liability whatsoever for the use of the information contained herein. The information contained herein is provided "AS IS, WHERE IS" and with all faults, and the entire risk associated with such information is entirely with the user. All information contained herein is subject to change without notice. Customers should obtain and verify the latest relevant information before placing orders for TriQuint products. The information contained herein or any use of such information does not grant, explicitly or implicitly, to any party any patent rights, licenses, or any other intellectual property rights, whether with regard to such information itself or anything described by such information.

TriQuint products are not warranted or authorized for use as critical components in medical, life-saving, or life-sustaining applications, or other applications where a failure would reasonably be expected to cause severe personal injury or death.