



# QPA2628D

## 25 – 31 GHz GaAs Low Noise Amplifier

### Product Overview

Qorvo's QPA2628D is a high-performance, low noise amplifier fabricated on Qorvo's production 90nm pHEMT (QPHT09) process. Covering 25–31 GHz, the QPA2628D provides 22 dB small signal gain and P1dB of 19 dBm, while supporting a noise figure of 1.7 dB and IM3 levels of -53 dBc (at Pout=0 dBm/tone).

The QPA2628D is in die form, 2.40 x 1.00 x 0.10 mm, with both RF ports matched to 50 ohms and with integrated DC blocking caps on both I/O ports for simple system integration.

The QPA2628D's high performance and low power consumption make it ideal for satellite and military or commercial radar applications.



### Key Features

- Frequency Range: 25–31 GHz
- Noise Figure: 1.7 dB (typical)
- Small Signal Gain: 22 dB (typical)
- P1dB: 19 dBm (typical)
- IM3: -53 dBc (Pout=0 dBm/tone) (typical)
- Bias:  $V_D = 3.5$  V,  $I_{DQ} = 90$  mA,  $V_G = -0.46$  V (typical)
- Die Dimensions: 2.40 x 1.00 x 0.10 mm

### Functional Block Diagram

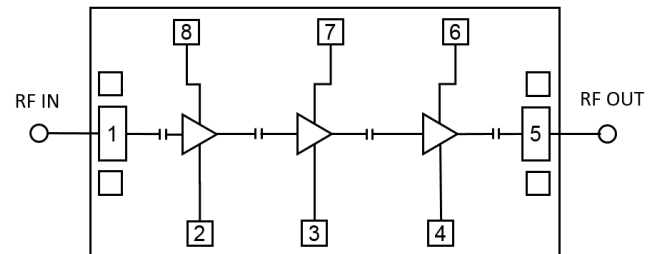

### Applications

- Satellite Communications
- Military and Commercial Radar Applications

### Ordering Information

Part No.	Description
QPA2628D	25 – 31 GHz GaAs Low Noise Amplifier
1136447	QPA2628D Evaluation Board

## Absolute Maximum Ratings

Parameter	Rating	Units
Drain Voltage ( $V_D$ )	4.5	V
Drain Current ( $I_{D1}/I_{D2}/I_{D3}$ )	45/45/160	mA
Gate Voltage Range ( $V_G$ )	-1.3 to 0	V
Gate Current ( $I_{G1}/I_{G2}/I_{G3}$ at 125 °C)	5.0/5.0/6.6	mA
RF Input Power (50 $\Omega$ , 85 °C)	20	dBm
Channel Temperature, $T_{CH}$	175	°C
Mounting Temperature (30 seconds)	320	°C
Storage Temperature	-55 to 150	°C

Exceeding any one or a combination of the Absolute Maximum Rating conditions may cause permanent damage to the device. Extended application of Absolute Maximum Rating conditions to the device may reduce device reliability.

## Recommended Operating Conditions

Parameter	Value	Units
Drain Voltage	3.5	V
Drain Current (quiescent, $I_{DQ}$ )	90	mA
Drain Current ( $I_D$ , Low noise / $P_{SAT}$ )	90 / 200	mA
Gate Voltage (typical)	-0.46	V
Operating Temperature Range	-40 to 85	°C

Electrical specifications are measured at specified test conditions. Specifications are not guaranteed over all recommended operating conditions.

## Electrical Specifications

Test conditions unless otherwise noted:  $V_D = +3.5V$ ,  $I_{DQ} = 90$  mA, Temp. = +25 °C. Data de-embedded to MMIC bond wires.

Parameter	Min	Typ	Max	Units
Operating Frequency	25		31	GHz
Small Signal Gain		22		dB
Noise Figure		1.7		dB
1-dB Compression Point		19		dBm
Input Return Loss		8		dB
Output Return Loss		14		dB
3 <sup>RD</sup> Order Intermodulation Level ( $P_{OUT} = 0$ dBm / Tone)		-53		dBc
Output TOI ( $P_{out} = 0$ dBm / tone)		27		dBm
Gain (S21) Temperature Coefficient		-0.013		dB/°C

## Performance Plots – Small Signal

Test conditions unless otherwise noted:  $V_D = +3.5V$ ,  $I_{DQ} = 90\text{ mA}$ , Temp. =  $+25\text{ }^\circ\text{C}$

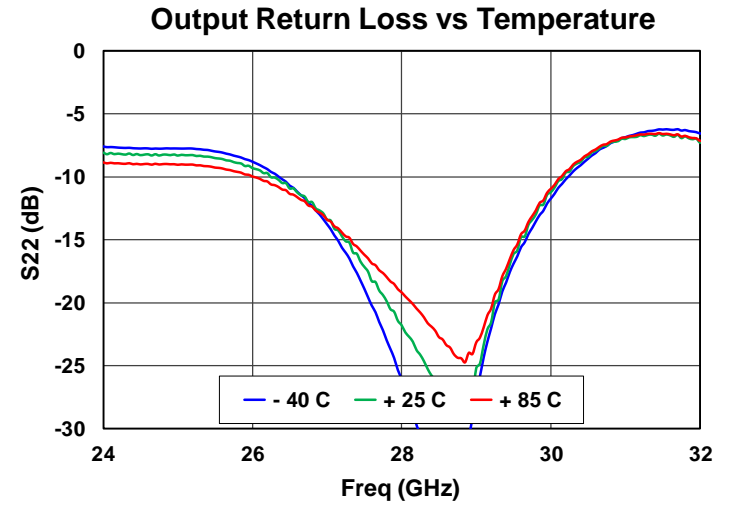
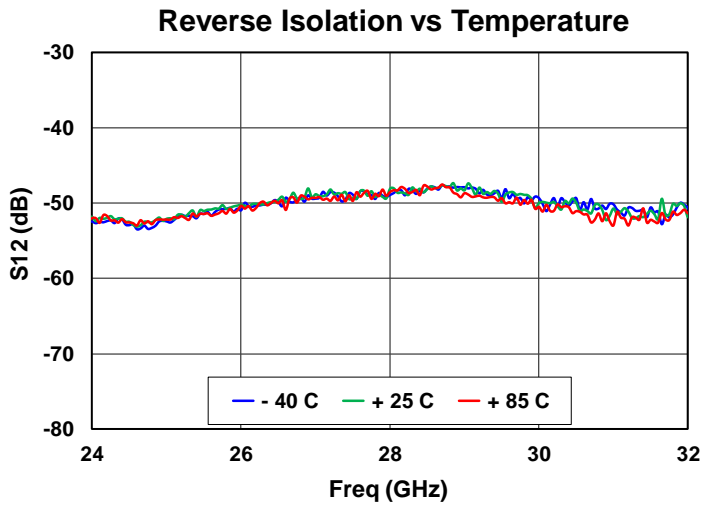
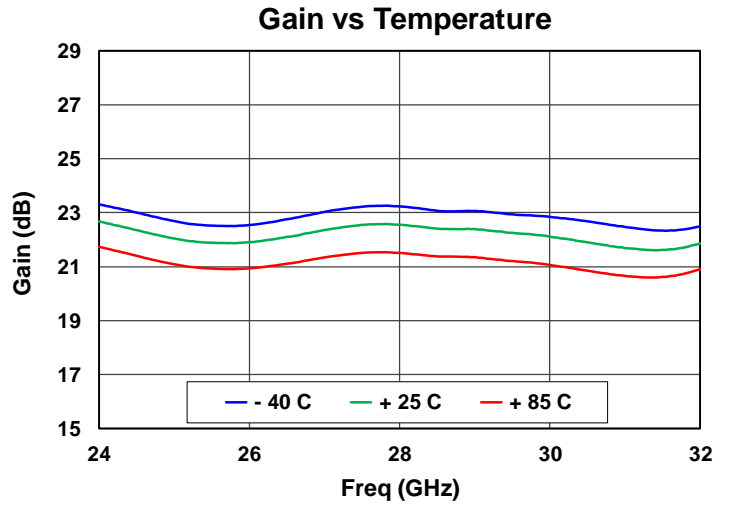
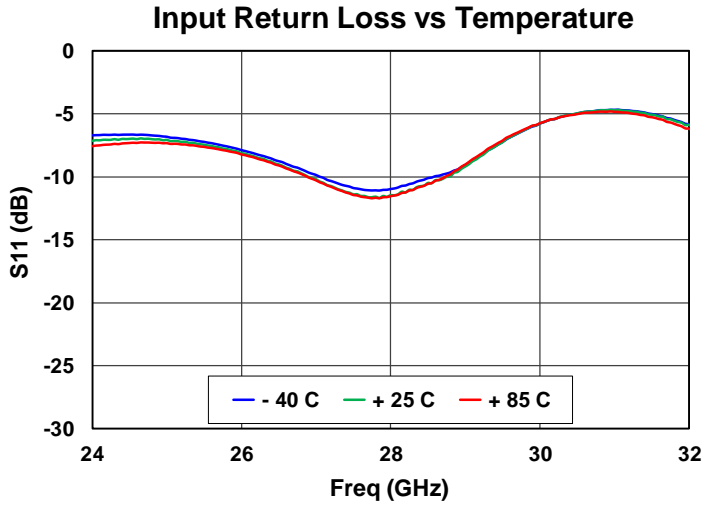

**Performance Plots – Small Signal**

Test conditions unless otherwise noted:  $V_D = +3.5V$ ,  $I_{DQ} = 90\text{ mA}$ ,  $Temp. = +25\text{ }^\circ\text{C}$

**Gain vs Voltage**

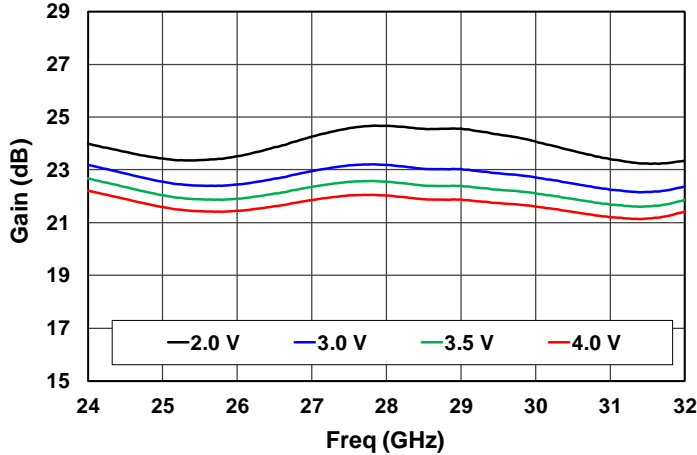

**Gain vs Current**

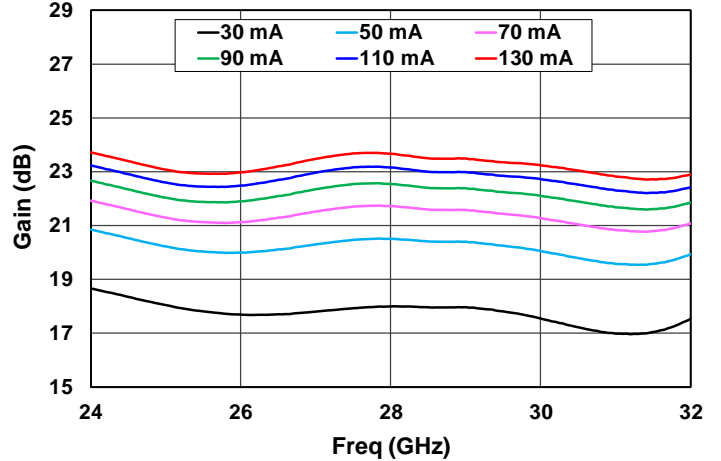

**Input Return Loss vs Voltage**

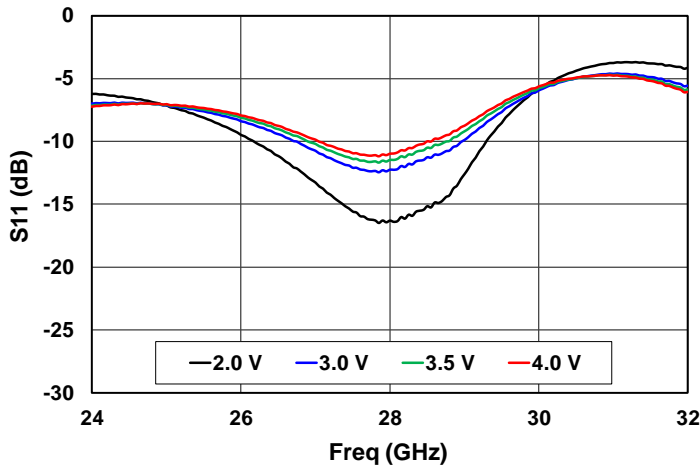

**Input Return Loss vs Current**

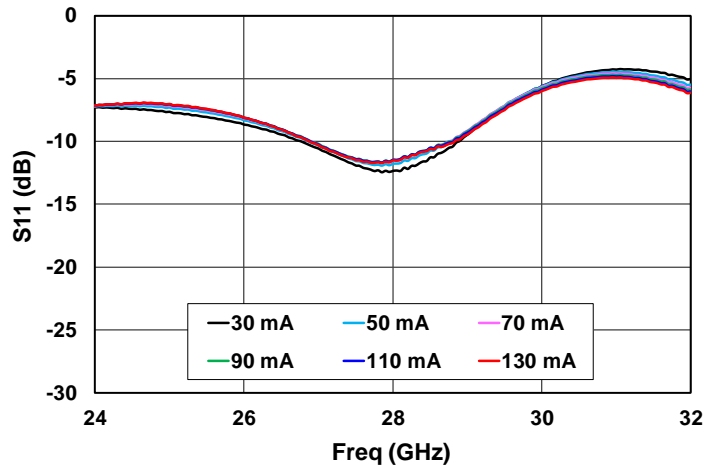

**Output Return Loss vs Voltage**

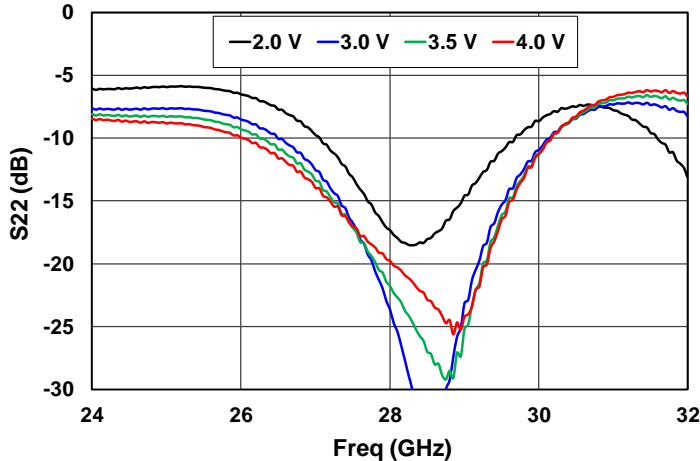

**Output Return Loss vs Current**

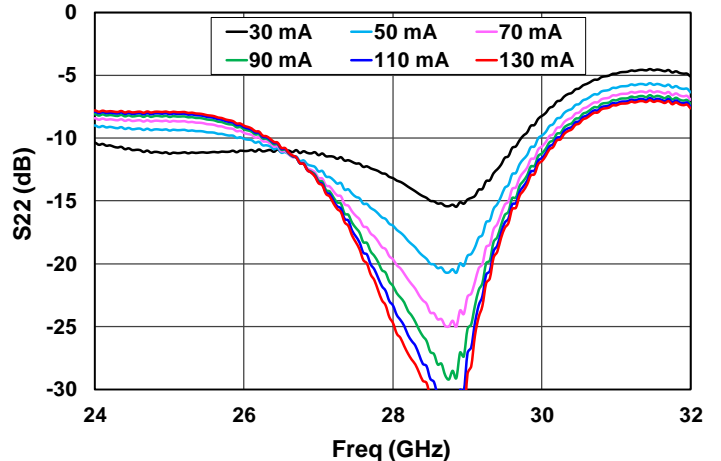

## Performance Plots – Noise Figure

Test conditions unless otherwise noted:  $V_D = +3.5V$ ,  $I_{BQ} = 90\text{ mA}$ , Temp. =  $+25\text{ }^\circ\text{C}$

**NF vs Temperature**

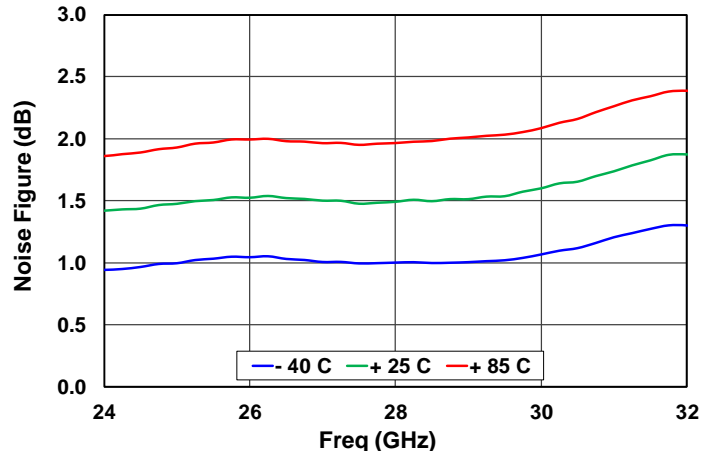

**NF vs Voltage**

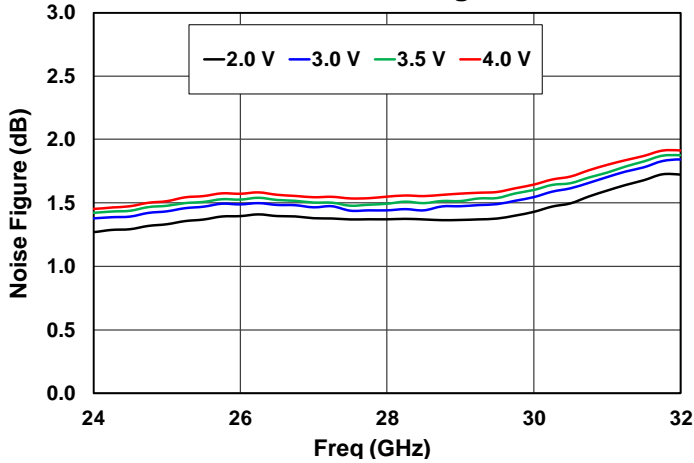

**NF vs Current**

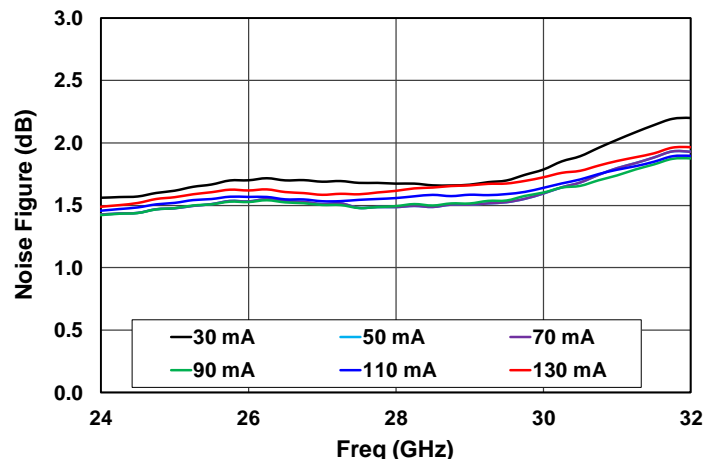

## Performance Plots – Large Signal

Test conditions unless otherwise noted:  $V_D = +3.5V$ ,  $I_{DQ} = 90\text{ mA}$ , Temp. =  $+25^\circ\text{C}$

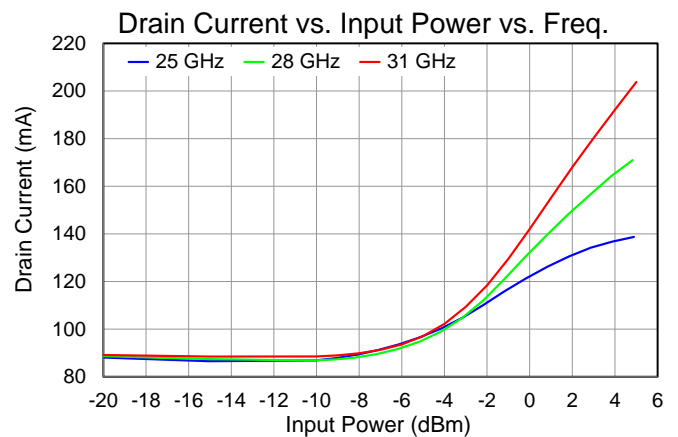
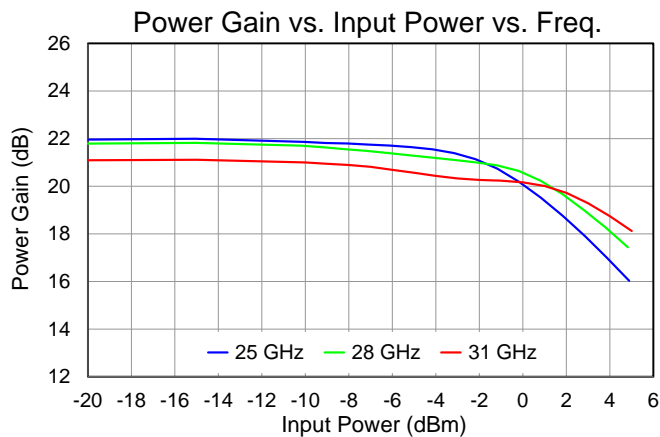
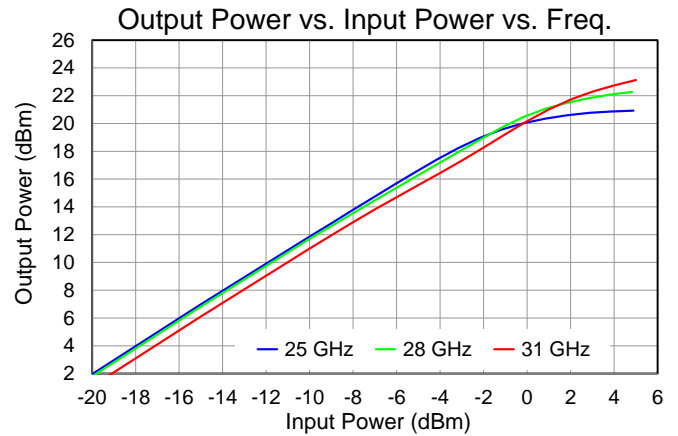
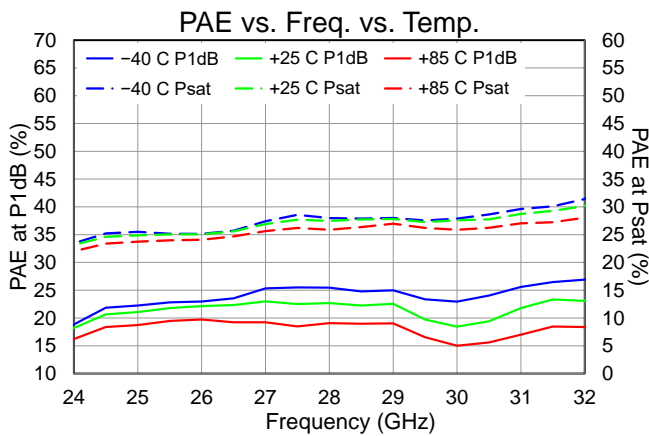
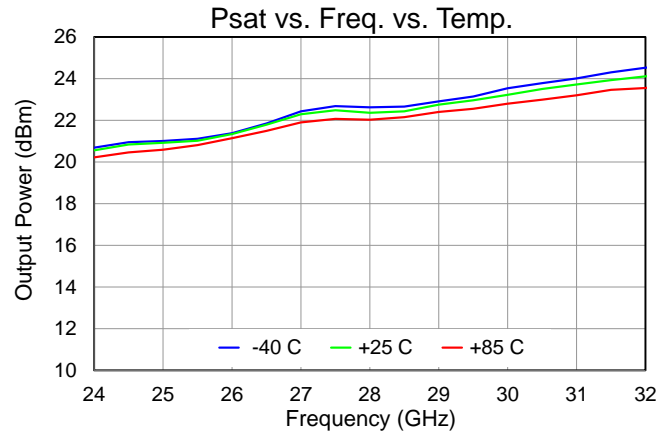
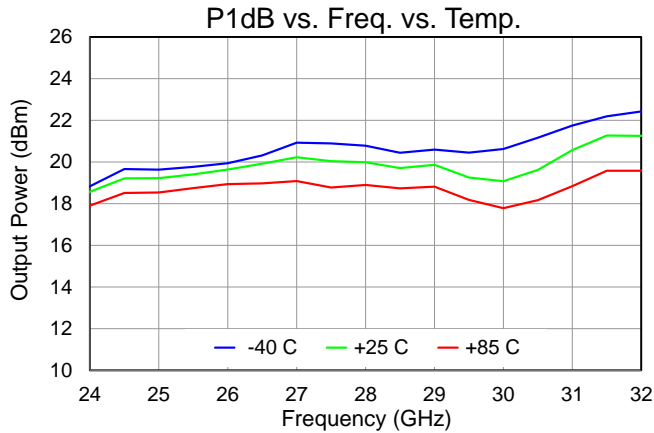

**Performance Plots – Linearity**

Test conditions unless otherwise noted:  $V_D = +3.5V$ ,  $I_{DQ} = 90\text{ mA}$ ,  $25\text{ }^\circ\text{C}$

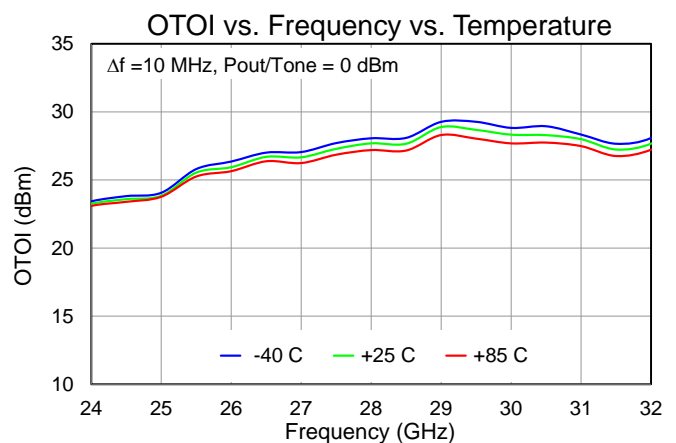
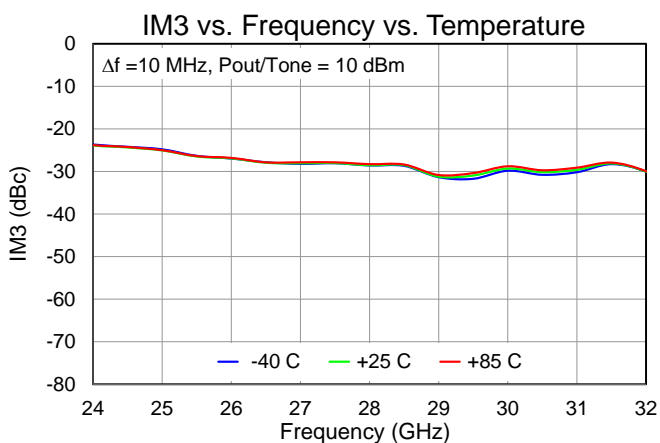
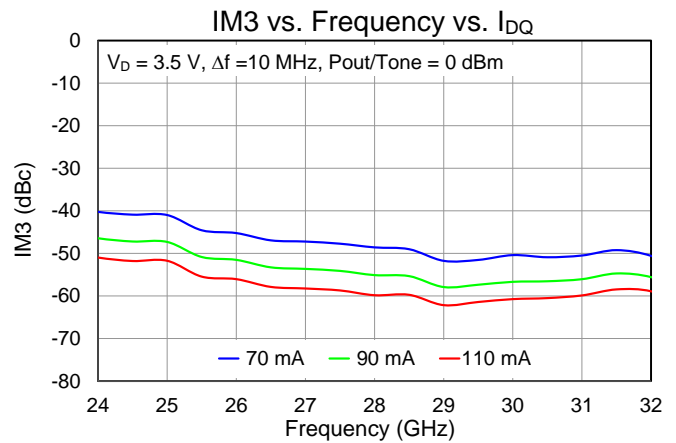
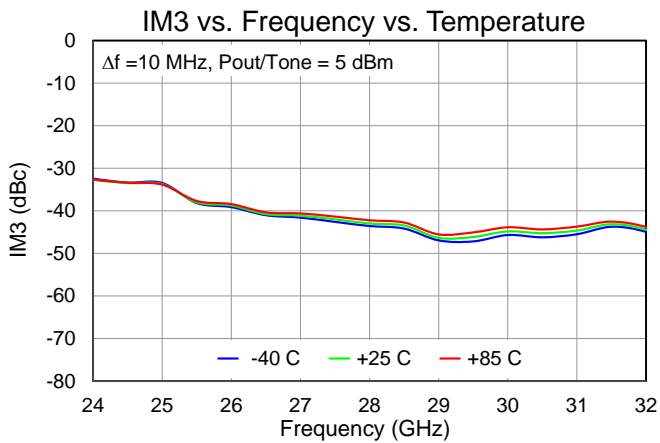
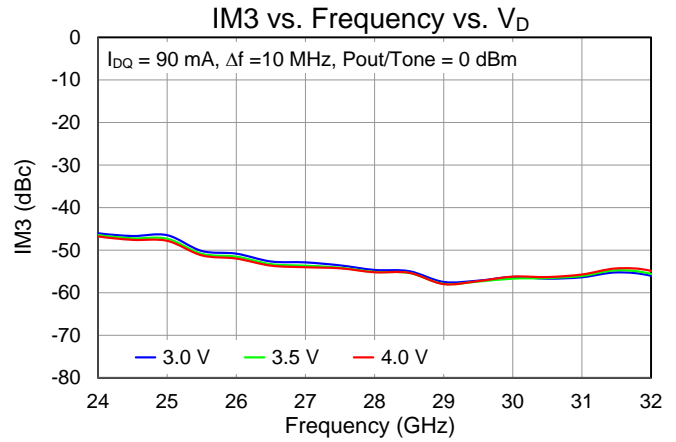
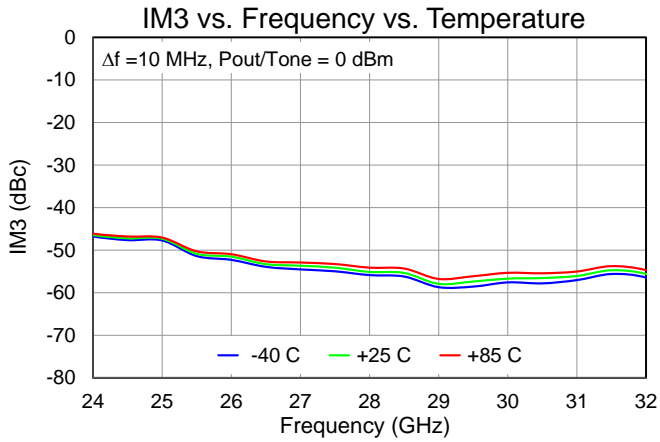

## Performance Plots – Linearity

Test conditions unless otherwise noted:  $V_D = +3.5V$ ,  $I_{DQ} = 90\text{ mA}$ ,  $25\text{ }^\circ\text{C}$

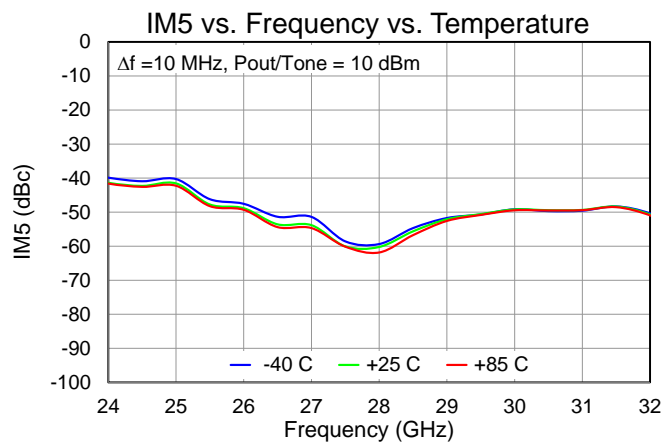
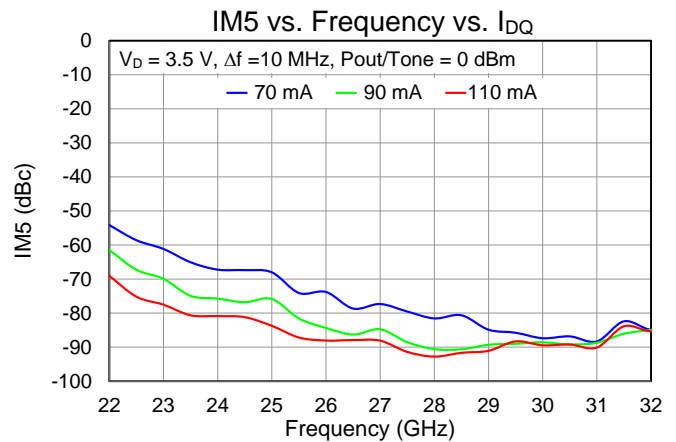
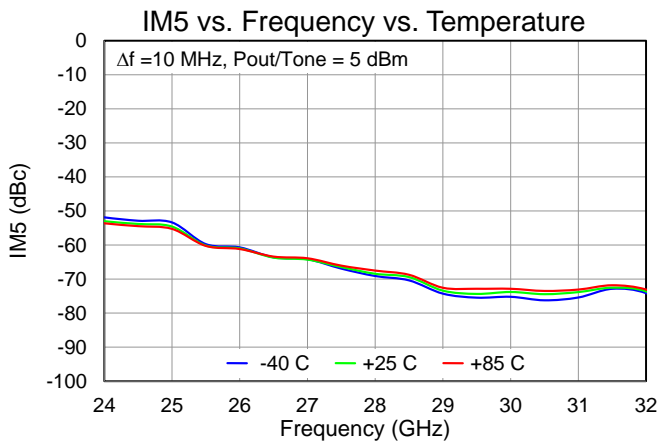
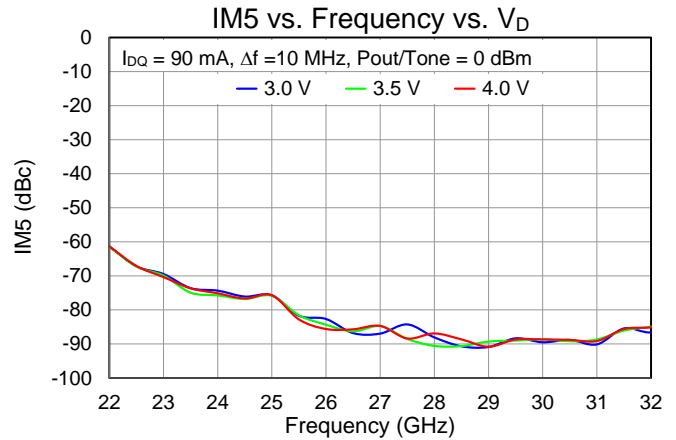
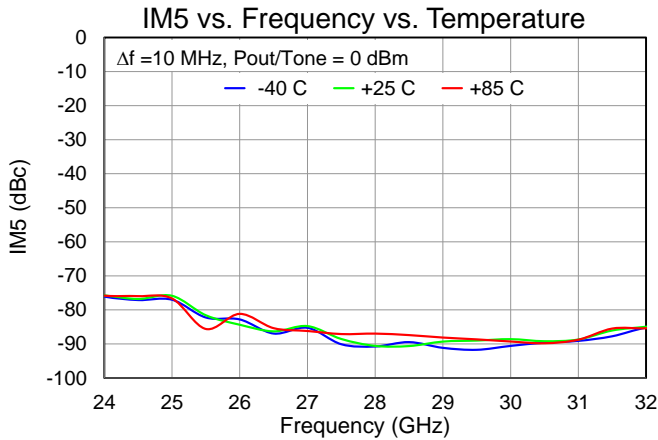



## Mechanical Drawing and Bond Pad Descriptions

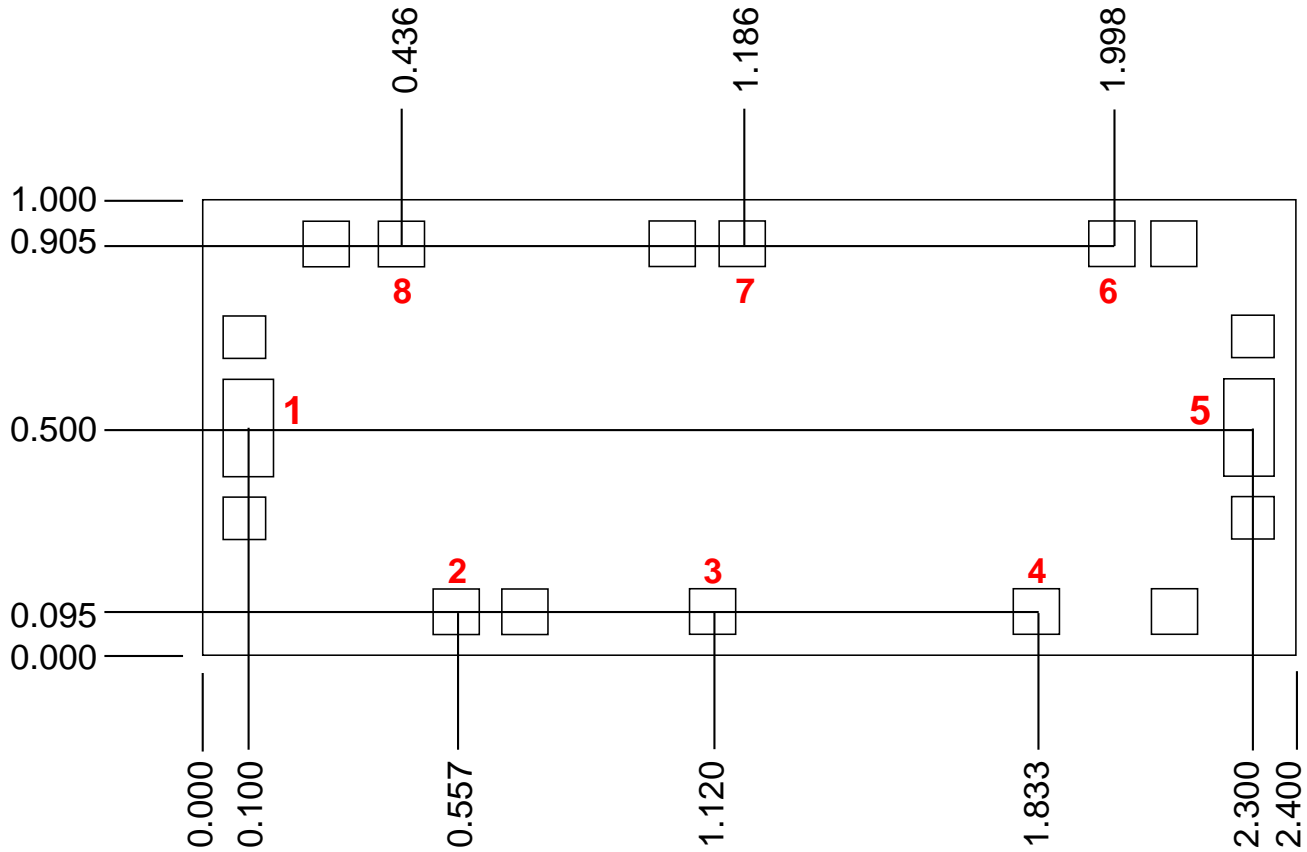

Dimensions in mm

Pad No.	Label	Pas Sizes (um)	Description
1	RF Input	91 x 197	Matched to 50 ohms, DC blocked
2	VG1	82 x 82	Gate Voltage; bias network is required ( $V_G$ can be tied together at PCB)
3	VG2	82 x 82	Gate Voltage; bias network is required ( $V_G$ can be tied together at PCB)
4	VG3	82 x 82	Gate Voltage; bias network is required ( $V_G$ can be tied together at PCB)
5	RF Output	91 x 197	Matched to 50 ohms, DC blocked
6	VD3	82 x 82	Drain Voltage; bias network is required ( $V_D$ can be tied together at PCB)
7	VD2	82 x 82	Drain Voltage; bias network is required ( $V_D$ can be tied together at PCB)
8	VD1	82 x 82	Drain Voltage; bias network is required ( $V_D$ can be tied together at PCB)

## Assembly Notes

---

Component placement and adhesive attachment assembly notes:

- Vacuum pencils and/or vacuum collets are the preferred method of pick up.
- Air bridges must be avoided during placement.
- The force impact is critical during auto placement.
- Organic attachment (i.e., conductive epoxy) can be used in low-power applications.
- Curing should be done in a convection oven; proper exhaust is a safety concern.

Reflow process assembly notes:

- Use AuSn (80/20) solder and limit exposure to temperatures above 300°C to 3-4 minutes, maximum.
- An alloy station or conveyor furnace with reducing atmosphere should be used.
- Do not use any kind of flux.
- Coefficient of thermal expansion matching is critical for long-term reliability.
- Devices must be stored in a dry nitrogen atmosphere.

Interconnect process assembly notes:

- Thermosonic ball bonding is the preferred interconnect technique.
- Force, time, and ultrasonics are critical parameters.
- Aluminum wire should not be used.
- Devices with small pad sizes should be bonded with 0.0007-inch wire.

Evaluation Board and BOM

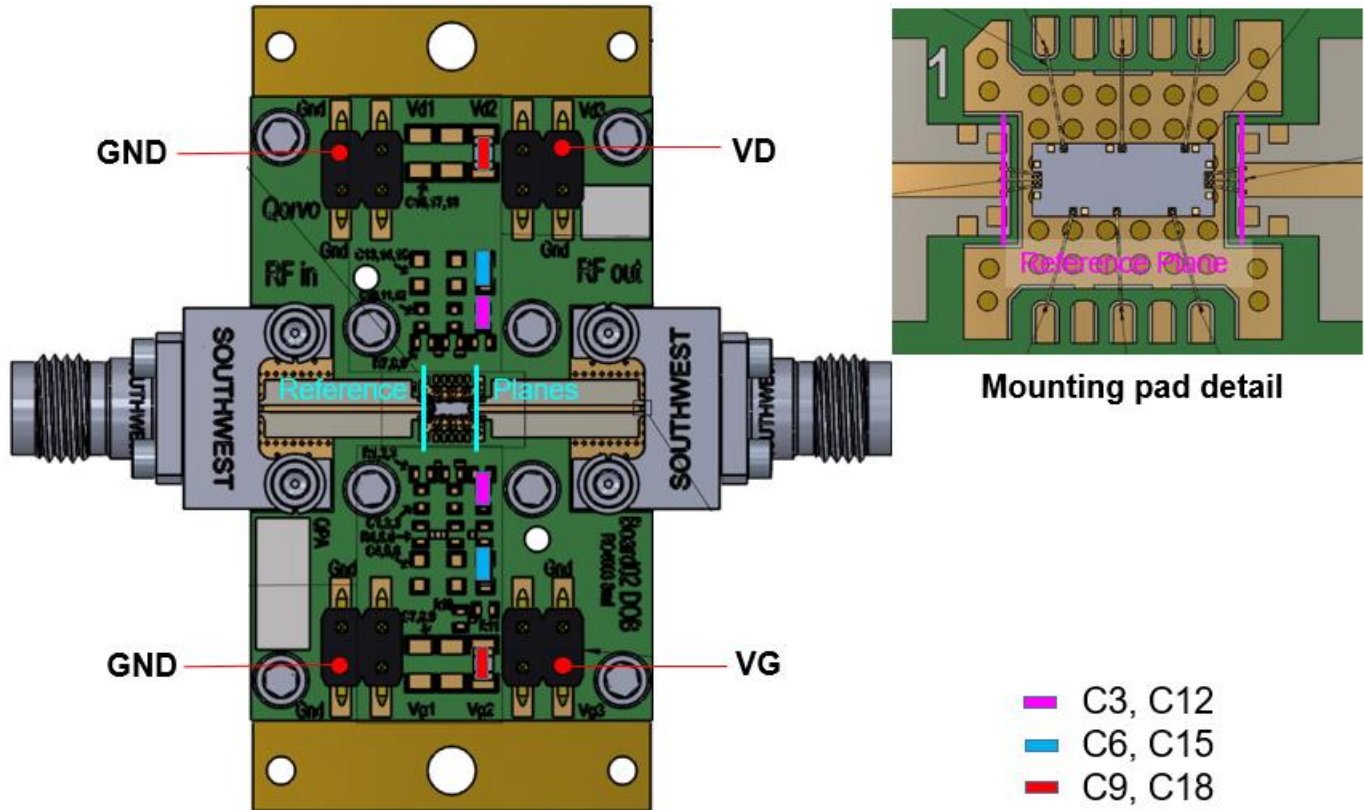

RF Layer is 0.008” thick Rogers Corp. RO4003C ( $\epsilon_r = 3.35$ ). Metal layers are 0.5 oz. copper. The microstrip line at the connector interface is optimized for the Southwest Microwave end launch connector 1492-04A-5. PCB level tuning at input side is recommended for optimal performance.

All data de-embedded to the MMIC bondwires (shown).

Note: Multiple vias should be employed under die to minimize inductance and thermal resistance.

Bill of Material – Evaluation Board

Ref. Des.	Value	Description	Manuf.	Part Number
C3, C12	0.01 uF	CAP 0.01uF +/-10% 50V 0402 X7R ROHS	Various	
C6, C15	1.0 uF	CAP 1.0uF +/-10% 16V 0603 X7R ROHS	Various	
C9, C18	10 uF	CAP CER 10uF 10V X7R 10% 0805 TDK ROHS	Various	
RF IN, RF OUT	2.4 mm	2.4 MM END LAUNCH CONNECTOR	Southwest Microwave	1492-04A-5

## Application Circuit

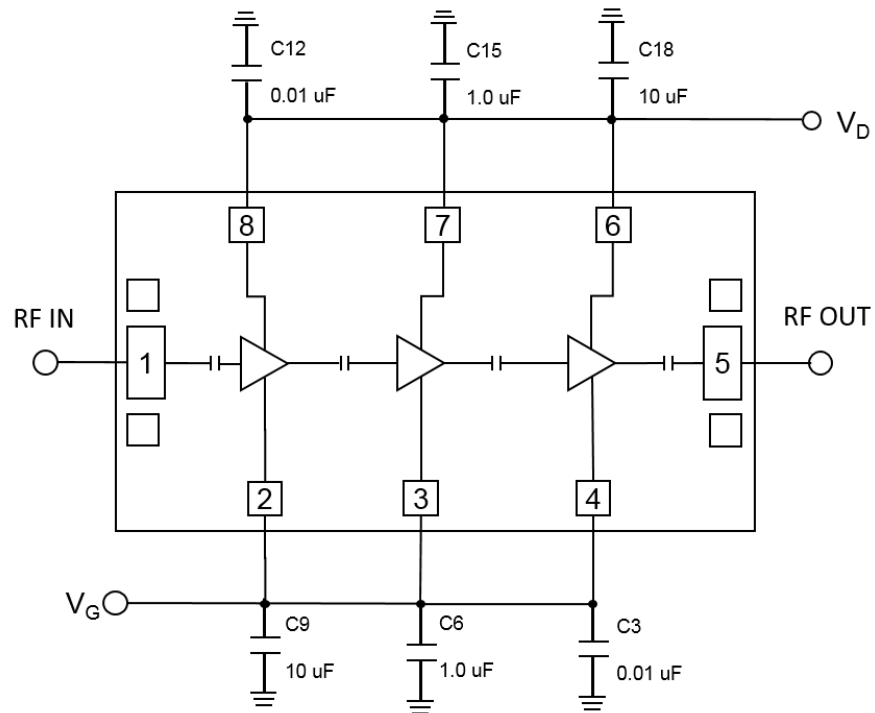

**Notes:**

1. Can use separate gate and drain for individual stage controls.

### Bias-up Procedure

1. Set  $I_D$  limit to 220 mA,  $I_G$  limit to 10 mA
2. Set  $V_G$  to  $-1.3$  V
3. Set  $V_D$  to  $+3.5$  V
4. Adjust  $V_G$  more positive until  $I_{DQ} = 90$  mA  
( $V_G \approx -0.46$  V Typical)
5. Apply RF signal

### Bias-down Procedure

1. Turn off RF signal
2. Reduce  $V_G$  to  $-1.3$  V. Ensure  $I_{DQ} \approx 0$  mA
3. Set  $V_D$  to 0V
4. Turn off  $V_D$  supply
5. Turn off  $V_G$  supply

## Thermal and Reliability Information

Parameter	Test Conditions	Value	Units
Thermal Resistance ( $\theta_{JC}$ ) <sup>(1)</sup>	$T_{base} = 85^{\circ}\text{C}$ , $V_D = 3.5\text{ V}$ , $I_{DQ} = 90\text{ mA}$ Quiescent/Small Signal operation, $P_{DISS} = 0.315\text{ W}$	65.1	$^{\circ}\text{C}/\text{W}$
Channel Temperature, $T_{CH}$ (Under RF)		105.5	$^{\circ}\text{C}$
Median Lifetime ( $T_M$ )		1.236E08	Hrs

Notes:

- Die mounted to 40 mil CuMo carrier plate with AuSn eutectic. Thermal resistance measured at back of carrier plate.

## Median Lifetime

Test Conditions:  $V_D = +4\text{ V}$   
 Failure Criteria is 10% reduction in  $I_{D\_MAX}$

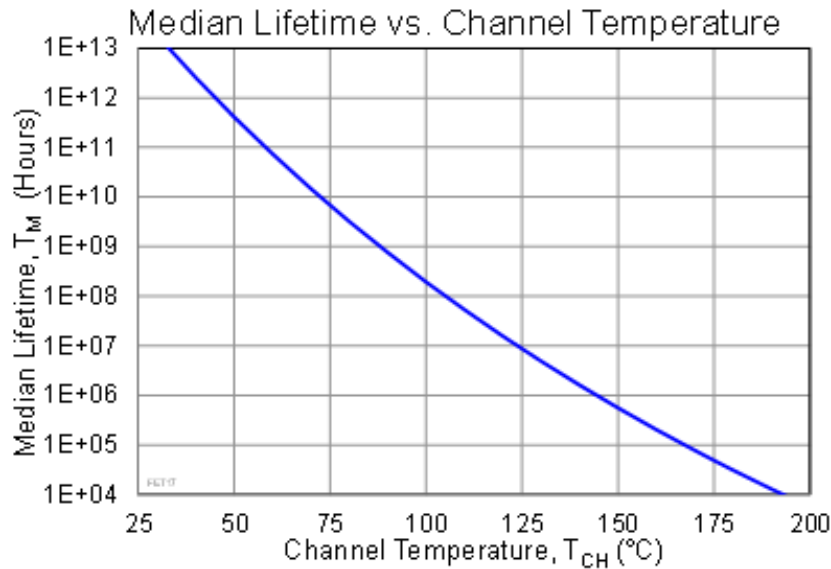

## Handling Precautions

Parameter	Rating	Standard
ESD – Human Body Model (HBM)	1A	ESDA / JEDEC JS-001-2012



Caution!  
ESD-Sensitive Device

## RoHS Compliance

This part is compliant with 2011/65/EU RoHS directive (Restrictions on the Use of Certain Hazardous Substances in Electrical and Electronic Equipment) as amended by Directive 2015/863/EU.

This product also has the following attributes:

- Lead Free
- Halogen Free (Chlorine, Bromine)
- Antimony Free
- TBBP-A (C<sub>15</sub>H<sub>12</sub>Br<sub>4</sub>O<sub>2</sub>) Free
- SVHC Free

## Contact Information

For the latest specifications, additional product information, worldwide sales and distribution locations:

**Tel: 1-844-890-8163**

**Web: [www.qorvo.com](http://www.qorvo.com)**

**Email: [customer.support@qorvo.com](mailto:customer.support@qorvo.com)**

## Important Notice

The information contained in this Data Sheet and any associated documents (“Data Sheet Information”) is believed to be reliable; however, Qorvo makes no warranties regarding the Data Sheet Information and assumes no responsibility or liability whatsoever for the use of said information. All Data Sheet Information is subject to change without notice. Customers should obtain and verify the latest relevant Data Sheet Information before placing orders for Qorvo® products. Data Sheet Information or the use thereof does not grant, explicitly, implicitly or otherwise any rights or licenses to any third party with respect to patents or any other intellectual property whether with regard to such Data Sheet Information itself or anything described by such information.

DATA SHEET INFORMATION DOES NOT CONSTITUTE A WARRANTY WITH RESPECT TO THE PRODUCTS DESCRIBED HEREIN, AND QORVO HEREBY DISCLAIMS ANY AND ALL WARRANTIES WITH RESPECT TO SUCH PRODUCTS WHETHER EXPRESS OR IMPLIED BY LAW, COURSE OF DEALING, COURSE OF PERFORMANCE, USAGE OF TRADE OR OTHERWISE, INCLUDING THE IMPLIED WARRANTIES OF MERCHANTABILITY AND FITNESS FOR A PARTICULAR PURPOSE. Without limiting the generality of the foregoing, Qorvo® products are not warranted or authorized for use as critical components in medical, life-saving, or life-sustaining applications, or other applications where a failure would reasonably be expected to cause severe personal injury or death. Applications described in the Data Sheet Information are for illustrative purposes only. Customers are responsible for validating that a particular product described in the Data Sheet Information is suitable for use in a particular application.

© 2022 Qorvo US, Inc. All rights reserved. This document is subject to copyright laws in various jurisdictions worldwide and may not be reproduced or distributed, in whole or in part, without the express written consent of Qorvo US, Inc. | QORVO® is a registered trademark of Qorvo US, Inc.