

Product Description

The QPA3340 is a Hybrid Power Doubler amplifier module. The part employs GaAs/GaN die and is operated from 45 MHz to 1003 MHz. It provides excellent linearity and superior return loss performance with low noise and optimal reliability.



Package: SOT-115J

Functional Block Diagram

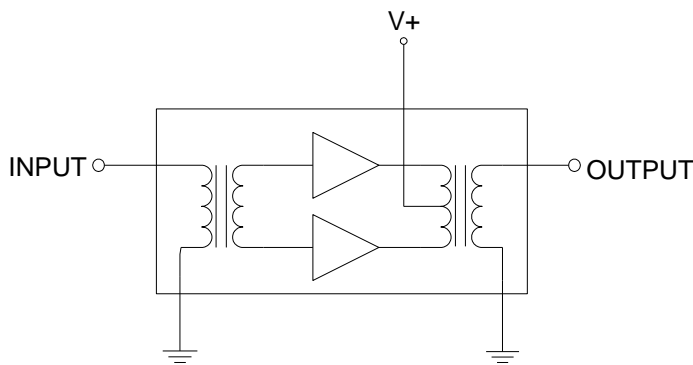

Product Features

- Excellent Linearity
- Superior Return Loss Performance
- Extremely Low Distortion
- Optimal Reliability
- Extremely Low Noise
- Unconditionally Stable Under all Terminations
- 22.5dB Min Gain at 1003 MHz
- 480 mA Max. at 24 VDC

Applications

- 45 – 1003 MHz CATV Amplifier Systems

Ordering Information

Part No.	Description
QPA3340	Box with 50 pcs

QPA3340 Absolute Maximum Ratings

Parameter	Value / Range
RF Input Voltage (single tone)	75 dBmV
DC Supply over-voltage (5 minutes)	+30 V
Storage Temperature	-40 to 100 °C
Operating Mounting Base Temperature	-30 to 100 °C

Operation of this device outside the parameter ranges given above may cause permanent damage.

Electrical Specifications

Parameter	Test Conditions: $V_+ = 24V$, $T_{MB} = 30^\circ C$, $Z_S = Z_L = 75\Omega$	Min	Typ	Max	Unit
Operational Frequency Range	–	40	–	1003	MHz
Gain	$f_o = 50$ MHz	21.3	21.8	22.3	dB
Gain	$f_o = 1003$ MHz	22.3	22.8	24.0	
Gain Slope	40 to 1003 MHz ^[1]	0.5	1.0	2.0	
Gain Flatness	40 to 1003 MHz			0.8	
Input Return Loss	$f_o = 40$ to 320 MHz	20		–	dB
	$f_o = 320$ to 640 MHz	19		–	
	$f_o = 640$ to 870 MHz	18		–	
	$f_o = 870$ to 1003 MHz	17		–	
Output Return Loss	$f_o = 40$ to 320 MHz	20		–	dB
	$f_o = 320$ to 640 MHz	19		–	
	$f_o = 640$ to 870 MHz	18		–	
	$f_o = 870$ to 1003 MHz	17		–	
Noise Figure	$f_o = 50$ to 1003 MHz	–		4.0	dB
IDC			470	480	mA
CTB			-73	-68	dBc
XMOD	$V_O = 61.0$ dBmV at 1000MHz, 18dB extrapolated tilt, 79 analog channels plus 75 digital channels (-6dB offset) ^{[2][4]}		-65	-60	dBc
CSO			-76	-70	dBc
CIN		55	60		dB
CTB			-77		dBc
XMOD	$V_O = 56.4$ dBmV at 1000MHz, 13.4dB extrapolated tilt, 79 analog channels plus 75 digital channels (-6dB offset) ^{[3][4]}		-75		dBc
CSO			-77		dBc
CIN			67		dB

1. The slope is defined as the difference between the gain at the start frequency and the gain at the stop frequency.
2. 79 analog channels, NTSC frequency raster: 55.25MHz to 547.25MHz, +43dBmV to +52.4dBmV tilted output level, plus 75 digital channels, -6dB offset relative to the equivalent analog carrier.
3. 79 analog channels, NTSC frequency raster: 55.25MHz to 547.25MHz, +43dBmV to +50.0dBmV tilted output level, plus 75 digital channels, -6dB offset relative to the equivalent analog carrier.
4. Composite Triple Beat (CTB) - The CTB parameter is defined by ANSI/SCTE 6.
Composite Second Order (CSO) - The CSO parameter (both sum and difference products) is defined by ANSI/SCTE 6.
Cross Modulation (XMOD) - Cross modulation (XMOD) is defined by ANSI/SCTE 58, measured at baseband (selective voltmeter method), referenced to 100% modulation of the carrier being tested.
Carrier to Intermodulation Noise (CIN) - The CIN parameter is defined by ANSI/SCTE 17 (Test procedure for carrier to noise).

Package Drawing (Dimensions in millimeters)

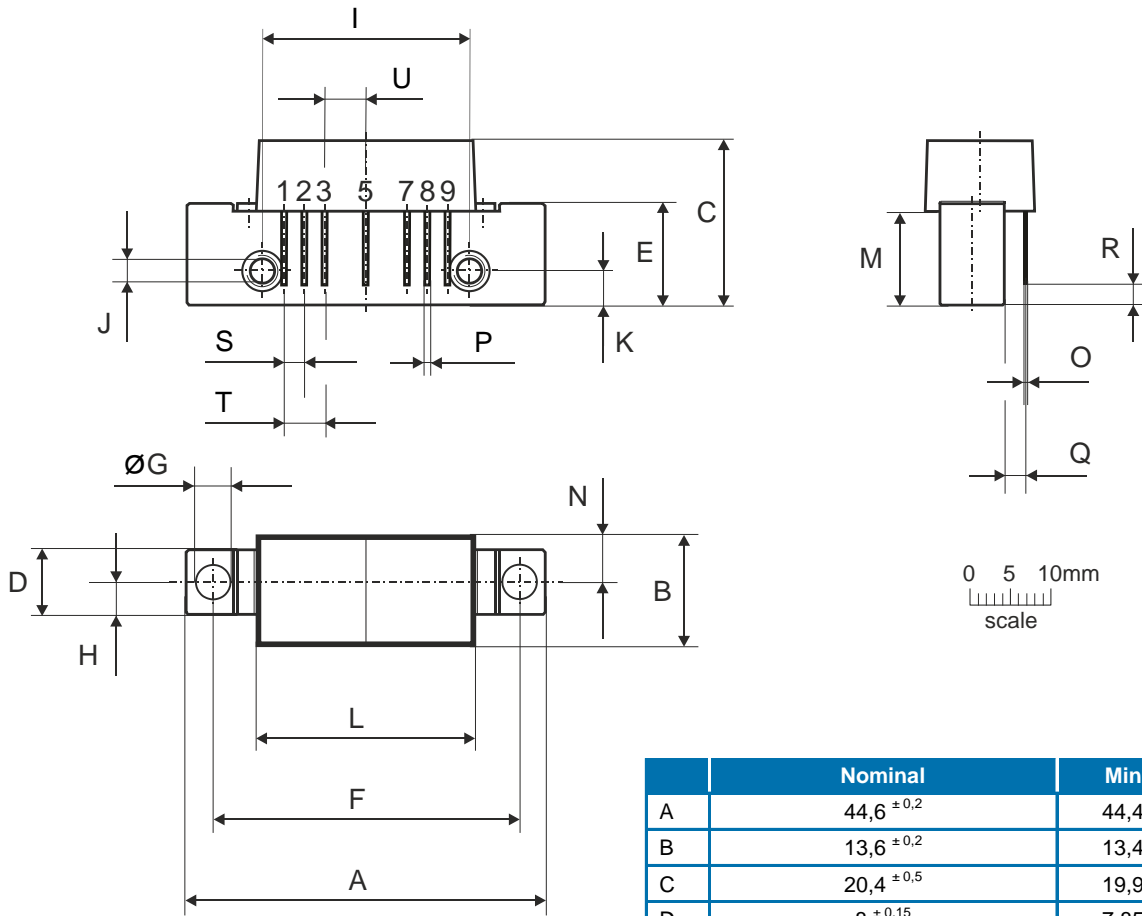

Notes:

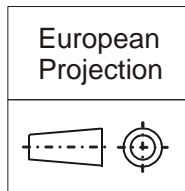

Pinning:

Pin	Name
1	Input
2-3	GND
4	
5	V+
6	
7-8	GND
9	Output

	Nominal	Min	Max
A	44,6 ^{±0,2}	44,4	44,8
B	13,6 ^{±0,2}	13,4	13,8
C	20,4 ^{±0,5}	19,9	20,9
D	8 ^{±0,15}	7,85	8,15
E	12,6 ^{±0,15}	12,45	12,75
F	38,1 ^{±0,2}	37,9	38,3
G	4 ^{+0,2/-0,05}	3,95	4,2
H	4 ^{±0,2}	3,8	4,2
I	25,4 ^{±0,2}	25,2	25,6
J	UNC 6-32	-	-
K	4,2 ^{±0,2}	4,0	4,4
L	27,2 ^{±0,2}	27,0	27,4
M	11,6 ^{±0,5}	11,1	12,1
N	5,8 ^{±0,4}	5,4	6,2
O	0,25 ^{±0,02}	0,23	0,27
P	0,45 ^{±0,03}	0,42	0,48
Q	2,54 ^{±0,3}	2,24	2,84
R	2,54 ^{±0,5}	2,04	3,04
S	2,54 ^{±0,25}	2,29	2,79
T	5,08 ^{±0,25}	4,83	5,33
U	5,08 ^{±0,25}	4,83	5,33

Handling Precautions

Parameter	Rating	Standard
ESD – Human Body Model (HBM)	1C	ANSI/ESD/JEDEC JS-001-2012



Caution!
ESD-Sensitive Device

RoHS Compliance

This part is compliant with 2011/65/EU RoHS directive (Restrictions on the Use of Certain Hazardous Substances in Electrical and Electronic Equipment) as amended by Directive 2015/863/EU.

Contact Information

For the latest specifications, additional product information, worldwide sales and distribution locations:

Web: www.qorvo.com

Tel: 1-844-890-8163

Email: customer.support@qorvo.com

Important Notice

The information contained herein is believed to be reliable; however, Qorvo makes no warranties regarding the information contained herein and assumes no responsibility or liability whatsoever for the use of the information contained herein. All information contained herein is subject to change without notice. Customers should obtain and verify the latest relevant information before placing orders for Qorvo products. The information contained herein or any use of such information does not grant, explicitly or implicitly, to any party any patent rights, licenses, or any other intellectual property rights, whether with regard to such information itself or anything described by such information. **THIS INFORMATION DOES NOT CONSTITUTE A WARRANTY WITH RESPECT TO THE PRODUCTS DESCRIBED HEREIN, AND QORVO HEREBY DISCLAIMS ANY AND ALL WARRANTIES WITH RESPECT TO SUCH PRODUCTS WHETHER EXPRESS OR IMPLIED BY LAW, COURSE OF DEALING, COURSE OF PERFORMANCE, USAGE OF TRADE OR OTHERWISE, INCLUDING THE IMPLIED WARRANTIES OF MERCHANTABILITY AND FITNESS FOR A PARTICULAR PURPOSE.**

Without limiting the generality of the foregoing, Qorvo products are not warranted or authorized for use as critical components in medical, life-saving, or life-sustaining applications, or other applications where a failure would reasonably be expected to cause severe personal injury or death.

Copyright 2016 © Qorvo, Inc. | Qorvo is a registered trademark of Qorvo, Inc.