

Product Description

An excellent alternative to traveling wave tube amplifiers, Qorvo’s Spatium™ QPB0220N is a solid state, spatial combining amplifier with an operating range of 2–18 GHz. With its maximum performance in output power, gain, power added efficiency, and frequency range, this Spatium is the ideal building block for microwave subsystems with wide-ranging applications.

Qorvo’s patented and field-proven Spatium combining technology provides unprecedented Solid-State Power Amplifier (SSPA) performance in a rugged, compact size and weight which reduces total cost of ownership compared to alternative technologies. This product offering combines Qorvo’s market leadership in GaN technology and MMIC design along with our high-count combining techniques for a best in class solution to power amplification.

The QPB0220N is equipped with an integrated bias card, which allows for convenience of operation, reducing electrical losses in the bias networks, and weight reduction over using a separate bias card. It provides individualized bias settings for each amplifier blade in the Spatium SSPA as well as drain pulsing up to 1 MHz PRF for superior power savings and noise performance.

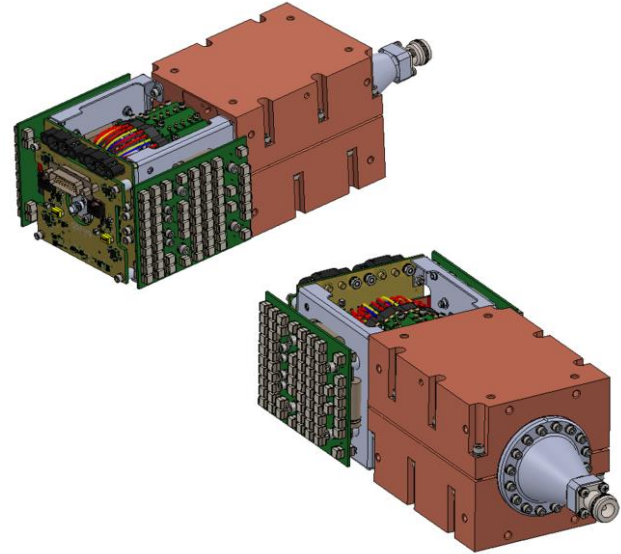

Input (T) and Output (B)

Functional Block Diagram

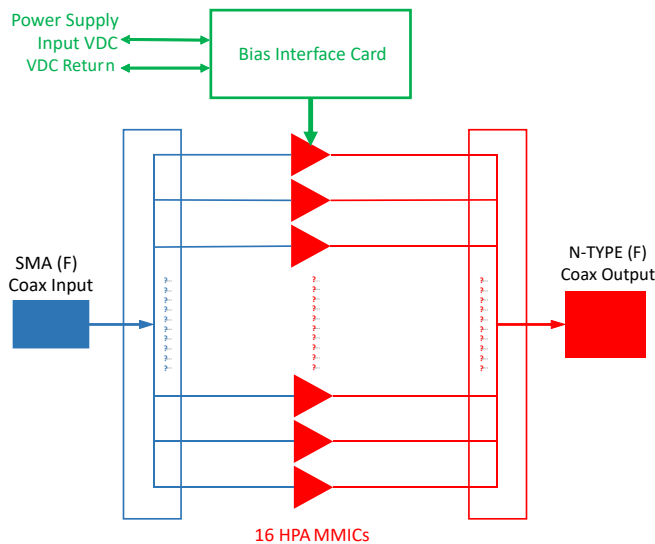

Product Features

- Frequency Range: 2–18 GHz
- Saturated Output Power: 53.4 dBm ($P_{IN} = 43$ dBm)
- Large Signal Gain: 10.4 dB ($P_{IN} = 43$ dBm)
- Solid State MMIC Reliability
- Multi-Element Redundancy
- Instant On (no warm-up)
- Integrated Bias Card

Performance is typical across frequency. Please reference electrical specification table and data plots for more details.

Applications

- TWTA Replacement

Ordering Information

Part No.	Description
QPB0220N	2–18 GHz Spatium™ Amplifier

Absolute Maximum Ratings

Parameter	Value / Unit
Prime Power (V_{DC})*	20 V
Drain Current (I_{D_DRIVE})	85 A
RF Input Power	49 dBm
Operating Temperature*	-40 to +85 °C

Operation of this device outside the parameter ranges given above may cause permanent damage. These are stress ratings only, and functional operation of the device at these conditions is not implied.

* Rating for thermal reliability

Recommended Operating Conditions

Parameter	Value / Unit
Drain Voltage (V_D)	18 V
Quiescent Drain Current (I_{DQ})	54 A
Operating Drain Current (I_D)**	58 A
Operating Temperature ***	-40 to +71 °C

Electrical specifications are measured at specified test conditions. Specifications are not guaranteed over all recommended operating conditions.

** Refer to plots on page 3 and 4 for I_D over frequency and temperature

*** Refers to outside clamp surface temperature

Electrical Specifications

Parameter	Min	Typ	Max	Units
Frequency	2		18	GHz
Saturated P_{OUT} , CW ($P_{IN} = 43$ dBm)		53.4		dBm
Power-Added Efficiency, CW ($P_{IN} = 43$ dBm)		19.5		%
Power Gain (CW, $P_{IN} = 43$ dBm)		10.4		dB
Small Signal Gain (S21)		16		dB
Input Return Loss		16		dB
Switching Time (PW=500 ns, F= 10 GHz, $P_{IN}=43$ dBm)				
ENABLE to RF ON		142		ns
ENABLE to RF OFF		132		ns
Second Harmonic, CW (In band, $P_{IN} = 43$ dBm)		-14		dBc
Third Harmonic, CW (In band, $P_{IN} = 43$ dBm)		-26		dBc
Input RF Interface		SMA (F)		
Output RF Interface		Type N (F)		
Weight: Amp + Bias Card		16.5 (7.48)		lbs. (kg)
Amp + Bias Card + One Capacitor Bank		17.0 (7.71)		lbs. (kg)
Amp + Bias Card + Two Capacitor Banks		17.5 (7.94)		lbs. (kg)
Dimensions: Amp + Bias Card (L) x (W) x (H)		11.33 x 3.4 x 3.4 (287.8 x 86.4 x 86.4)		inch (mm)
Amp + Bias Card + One Capacitor Bank		11.33 x 4.1 x 3.4 (287.8 x 104.1 x 86.4)		inch (mm)
Amp + Bias Card + Two Capacitor Banks		11.33 x 4.8 x 3.4 (287.8 x 121.9 x 86.4)		inch (mm)

Test conditions unless otherwise noted: $V_{DC} = 18$ V, $I_{DQ} = 54$ A, CW, T = 25 °C

Typical Performance – Large Signal (CW)

Conditions unless otherwise specified: $V_D = 18\text{ V}$, $I_{DQ} = 54\text{ A}$, $P_{IN} = 43\text{ dBm}$

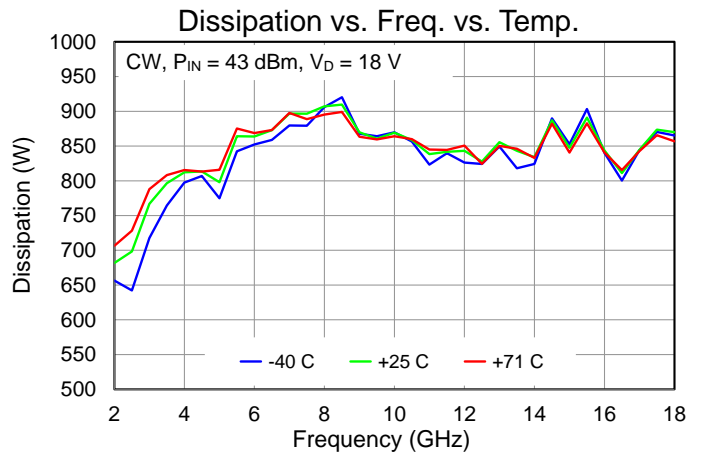
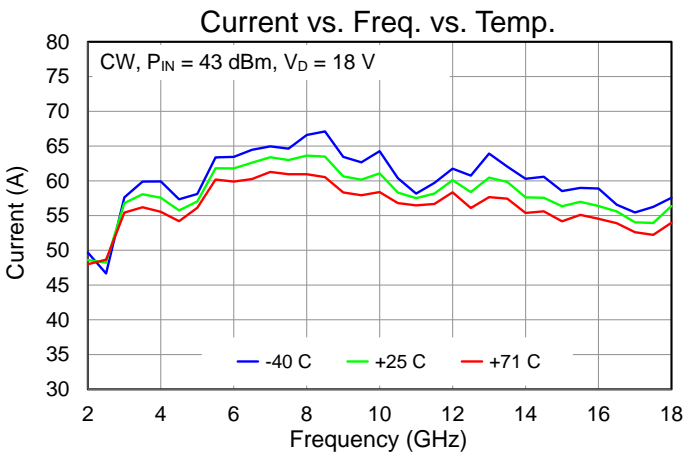
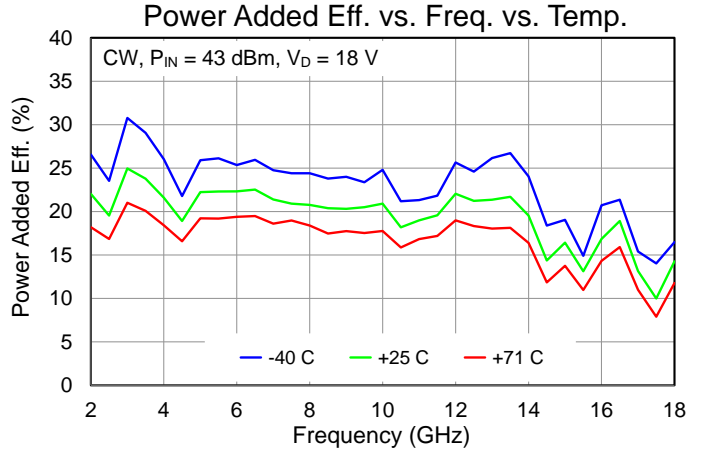
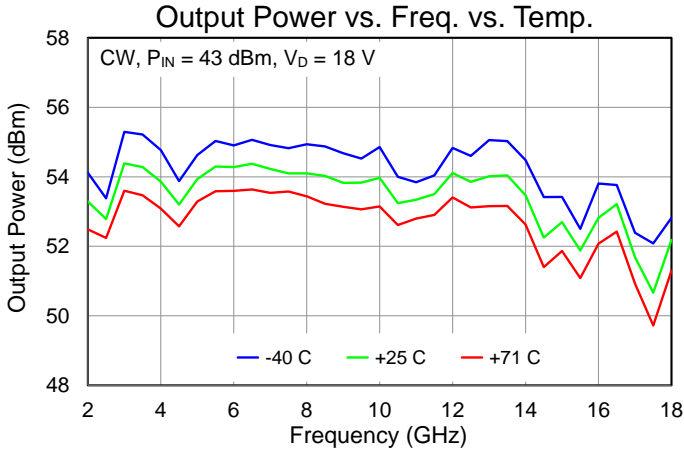

Typical Performance – Large Signal (Pulsed)

Conditions unless otherwise specified: $V_D = 18\text{ V}$, $I_{DQ} = 54\text{ A}$, $P_{IN} = 43\text{ dBm}$, $PW = 500\text{ ns}$, $DC = 50\%$

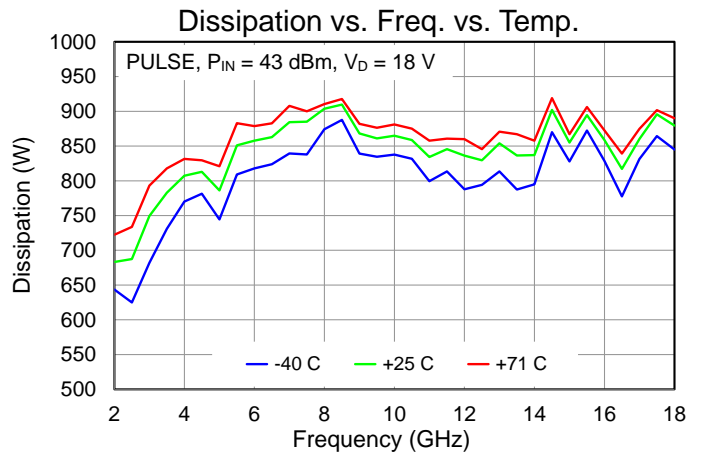
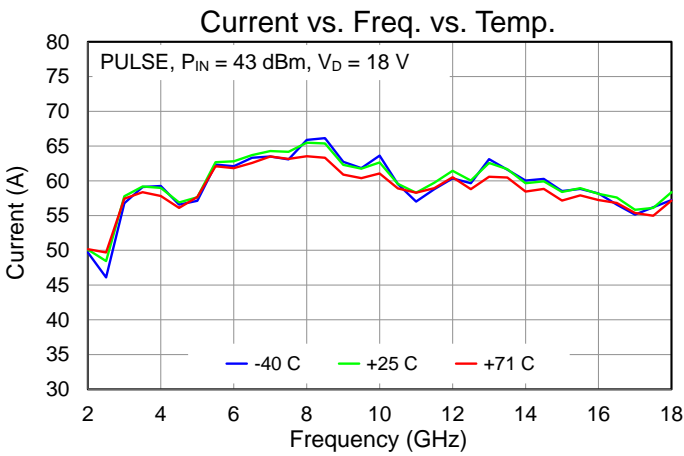
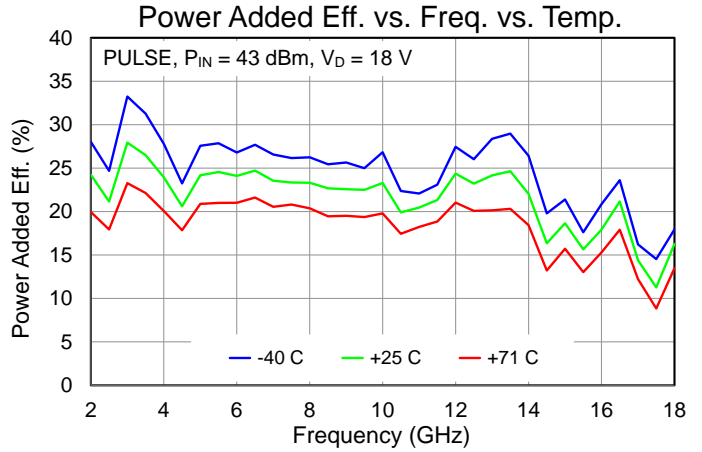
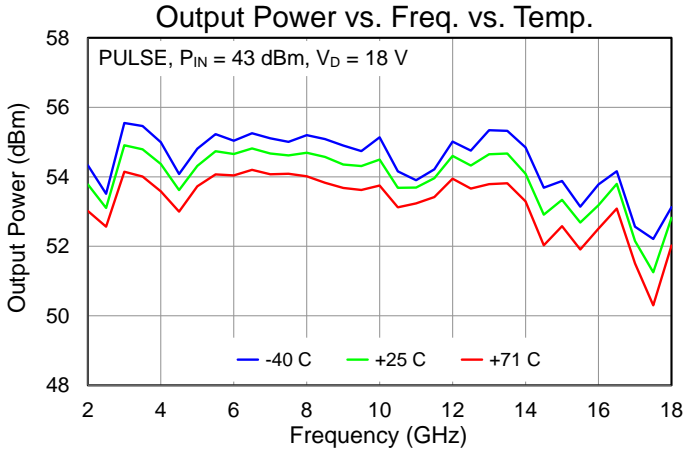

Typical Performance – Linearity, Harmonics, Small Signal

Conditions unless otherwise specified: $V_D = 18\text{ V}$, $I_{DQ} = 54\text{ A}$, $T = 25\text{ }^\circ\text{C}$, CW

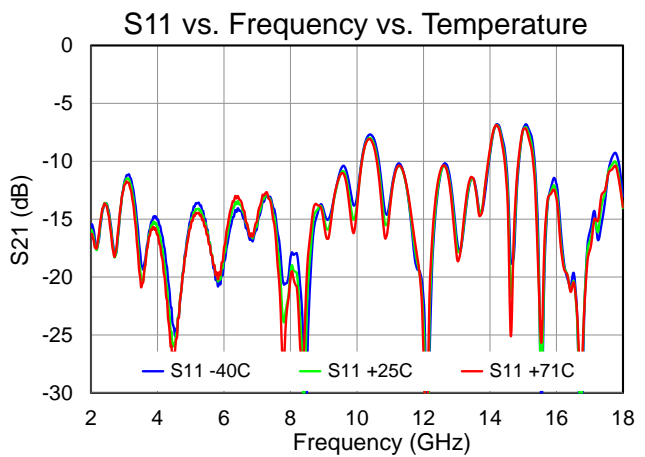
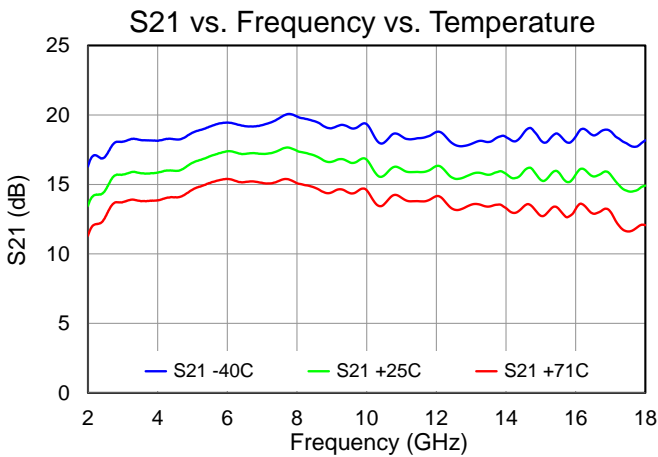
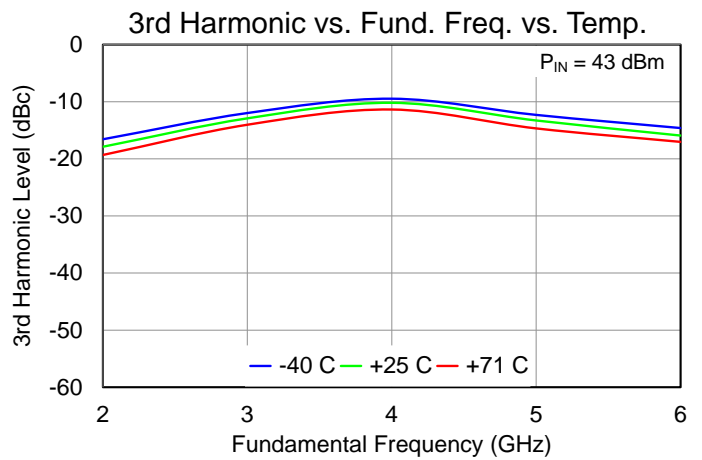
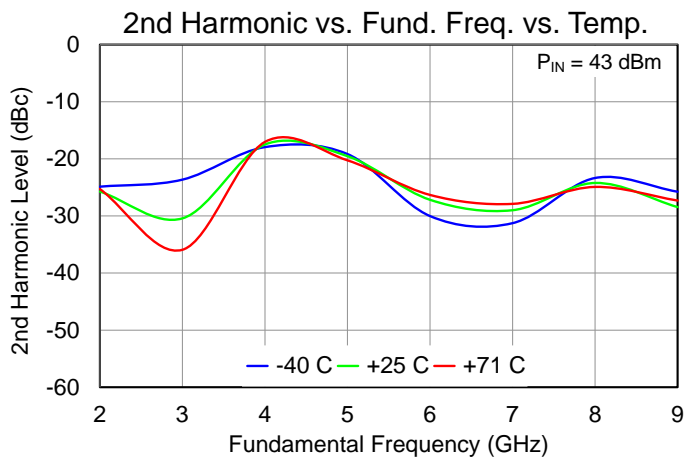
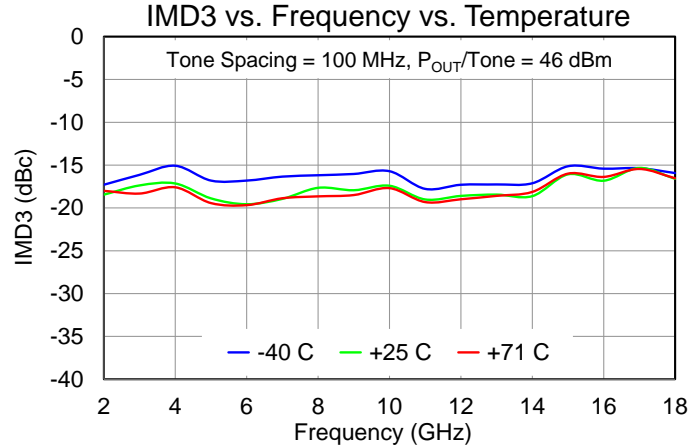

Reliability Information

Conditions unless otherwise specified: $V_D = 18\text{ V}$, $I_{DQ} = 54\text{ A}$, $P_{IN} = 43\text{ dBm}$

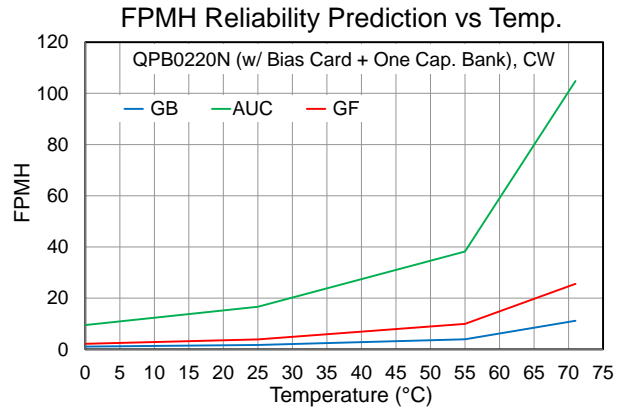
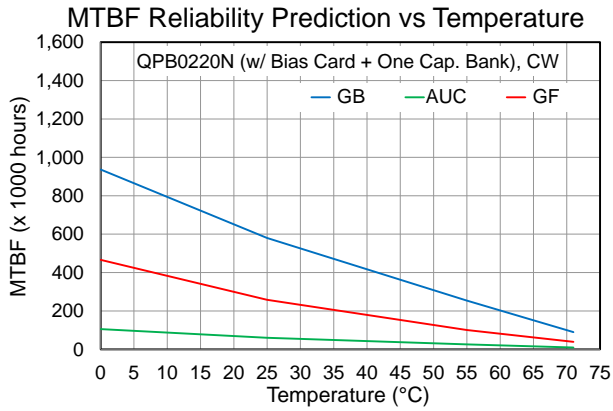

Calculations derived from MIL-HDBK-217F

Operational environments are:

GB – Ground Benign

GF – Ground Fixed

AUC – Airborne Uninhabited Cargo

Block Diagram and Description

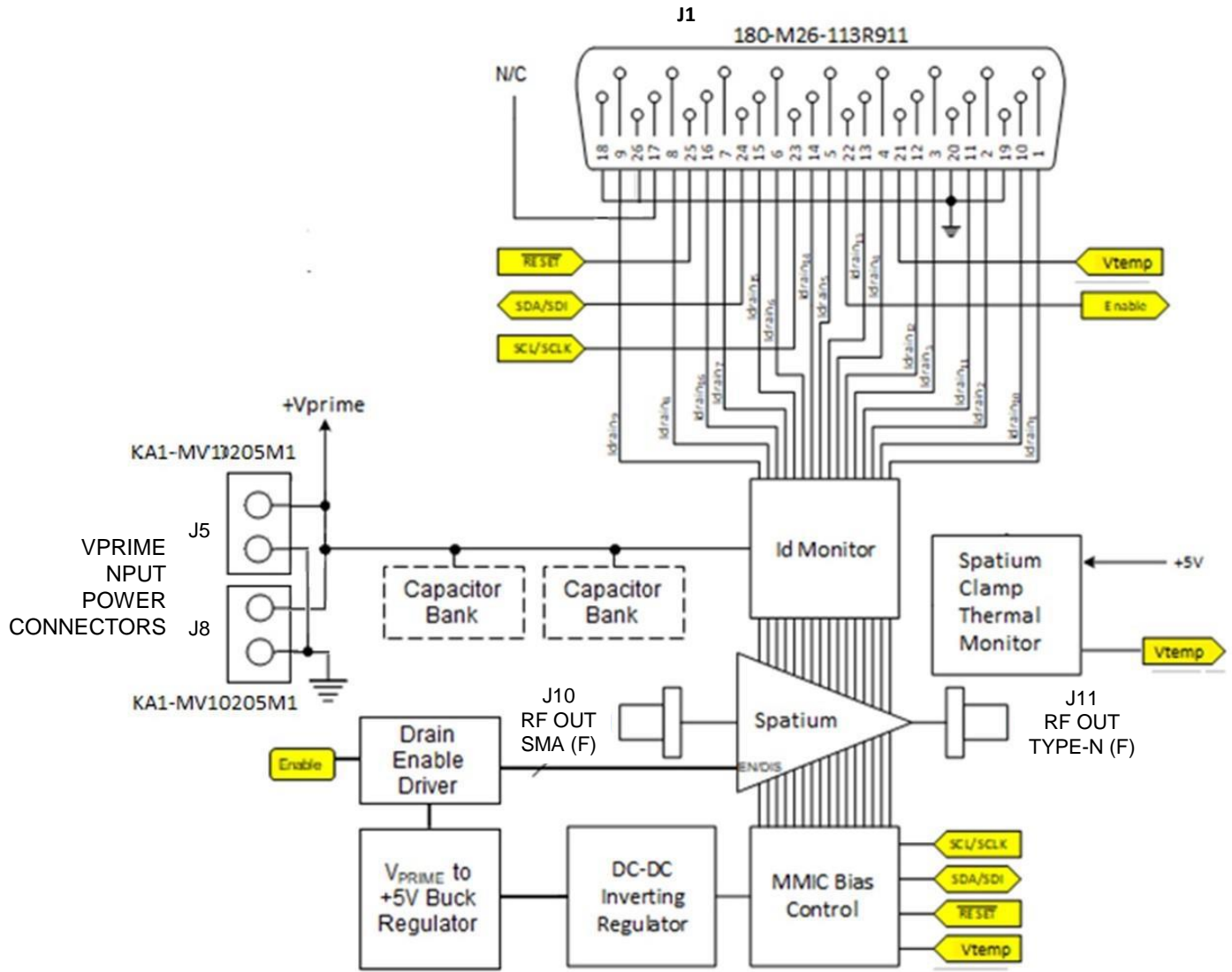

Pin No.	Label	Description
RF In	J10	SMA (F)
RF Out	J11	TYPE-N (F)
Auxiliary	J1	D-SUB HD 26POS (M), NORCOMP 180-M26-113R911
Power	J5, J8	HARWIN, KA1-MV10205M1

Mechanical Information – Outline Drawing (Amp + Bias Card)

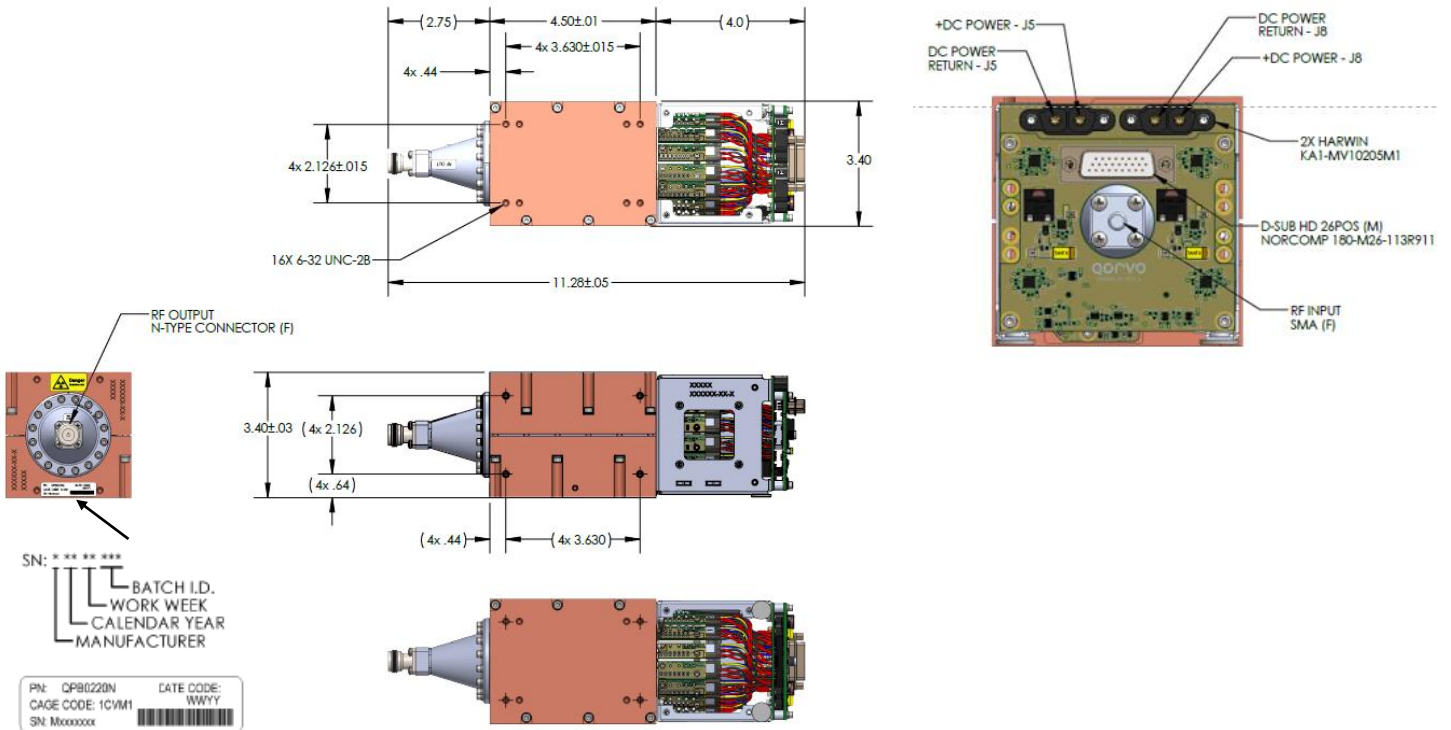

AS CONFIGURED W/O CAPACITOR BANKS

Dimensions are in INCHES

Mechanical Information – Outline Drawing (Amp + Bias Card + 2 Cap. Banks)

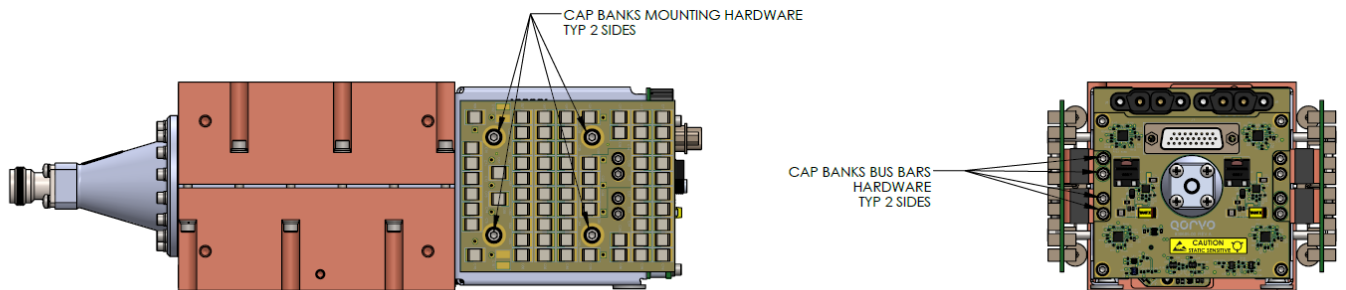
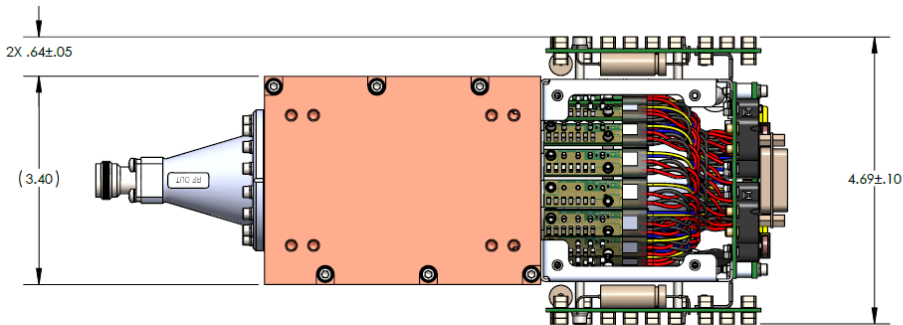

AS CONFIGURED WITH TWO CAPACITOR BANKS

Dimensions are in INCHES

Mechanical Information – Bias Card Connector Pins

J1 CONNECTOR PIN FUNCTION AND DEFINITION		
PIN NO.	FUNCTION	DESCRIPTION
J1-1	DRAIN 1	Voltage output on this pin follows 0.5V/A times the current flowing through channel 1 of the Spatium
J1-2	DRAIN 2	Voltage output on this pin follows 0.5V/A times the current flowing through channel 2 of the Spatium
J1-3	DRAIN 3	Voltage output on this pin follows 0.5V/A times the current flowing through channel 3 of the Spatium
J1-4	DRAIN 4	Voltage output on this pin follows 0.5V/A times the current flowing through channel 4 of the Spatium
J1-5	DRAIN 5	Voltage output on this pin follows 0.5V/A times the current flowing through channel 5 of the Spatium
J1-6	DRAIN 6	Voltage output on this pin follows 0.5V/A times the current flowing through channel 6 of the Spatium
J1-7	DRAIN 7	Voltage output on this pin follows 0.5V/A times the current flowing through channel 7 of the Spatium
J1-8	DRAIN 8	Voltage output on this pin follows 0.5V/A times the current flowing through channel 8 of the Spatium
J1-9	DRAIN 9	Voltage output on this pin follows 0.5V/A times the current flowing through channel 9 of the Spatium
J1-10	DRAIN 10	Voltage output on this pin follows 0.5V/A times the current flowing through channel 10 of the Spatium
J1-11	DRAIN 11	Voltage output on this pin follows 0.5V/A times the current flowing through channel 11 of the Spatium
J1-12	DRAIN 12	Voltage output on this pin follows 0.5V/A times the current flowing through channel 12 of the Spatium
J1-13	DRAIN 13	Voltage output on this pin follows 0.5V/A times the current flowing through channel 13 of the Spatium
J1-14	DRAIN 14	Voltage output on this pin follows 0.5V/A times the current flowing through channel 14 of the Spatium
J1-15	DRAIN 15	Voltage output on this pin follows 0.5V/A times the current flowing through channel 15 of the Spatium
J1-16	DRAIN 16	Voltage output on this pin follows 0.5V/A times the current flowing through channel 16 of the Spatium
J1-17	5V0	5V internally generated reference voltage
J1-18	5V0	5V internally generated reference voltage
J1-19	GND	Connect to logic ground
J1-20	GND	Connect to logic ground
J1-21	VTEMP	Connects to Texas Instruments LMT87 temperature sensor output
J1-22	ENABLE	5V logic command bit to turn on/off the drain voltage leading to each channel of the Spatium. 0V puts the unit into a low-power state while 5V will allow normal operation. In the absence of an external logic signal (open), the amplifier will power on with the application of the supply voltage.
J1-23	SCL	I2C bus used to program amplifier for operation. Please contact Qorvo applications engineering for further information.
J1-24	SDA	I2C bus used to program amplifier for operation. Please contact Qorvo applications engineering for further information.
J1-25	RESET	I2C bus used to program amplifier for operation. Please contact Qorvo applications engineering for further information.
J1-26	GND	Connect to logic ground.

J1-1 through J1-16 can be used for diagnostics / status of MMIC; otherwise, leave open.

J1-17 and J1-18 can be used to supply up to 100 mA of current if required. Otherwise, leave open. Do not apply a voltage to these pins.

J1-21 can be used to monitor the reference temperature of the Spatium. For the relationship between the sensor output voltage and temperature, please see the LMT87 datasheet.

<https://www.ti.com/lit/ds/symlink/lmt87.pdf>

Handling Precautions



Caution!
ESD-Sensitive Device

RF VOLTAGE HAZARD: Contact with RF fields at the output connector can cause burns or electric shock. High levels of RF/Microwave energy may be present when the unit is operating.

HIGH DC CURRENT HAZARD: High levels of DC current are present when the unit is operating.

Contact Information

For the latest specifications, additional product information, worldwide sales and distribution locations:

Web: www.qorvo.com

Tel: 1-844-890-8163

Email: customer.support@qorvo.com

Important Notice

The information contained herein is believed to be reliable; however, Qorvo makes no warranties regarding the information contained herein and assumes no responsibility or liability whatsoever for the use of the information contained herein. All information contained herein is subject to change without notice. Customers should obtain and verify the latest relevant information before placing orders for Qorvo products. The information contained herein or any use of such information does not grant, explicitly or implicitly, to any party any patent rights, licenses, or any other intellectual property rights, whether with regard to such information itself or anything described by such information. **THIS INFORMATION DOES NOT CONSTITUTE A WARRANTY WITH RESPECT TO THE PRODUCTS DESCRIBED HEREIN, AND QORVO HEREBY DISCLAIMS ANY AND ALL WARRANTIES WITH RESPECT TO SUCH PRODUCTS WHETHER EXPRESS OR IMPLIED BY LAW, COURSE OF DEALING, COURSE OF PERFORMANCE, USAGE OF TRADE OR OTHERWISE, INCLUDING THE IMPLIED WARRANTIES OF MERCHANTABILITY AND FITNESS FOR A PARTICULAR PURPOSE.**

Without limiting the generality of the foregoing, Qorvo products are not warranted or authorized for use as critical components in medical, life-saving, or life-sustaining applications, or other applications where a failure would reasonably be expected to cause severe personal injury or death.

© 2023 Qorvo US, Inc. All rights reserved. This document is subject to copyright laws in various jurisdictions worldwide and may not be reproduced or distributed, in whole or in part, without the express written consent of Qorvo US, Inc.