

Product Description

Qorvo's QPC1000 integrates a 5-bit digital phase shifter and a SPDT switch inside a small 6x5mm surface mount package. Individually, the Qorvo products include the TGP2100 phase shifter and the TGS4302 SPDT switch. Together, they support 360° of phase coverage over 29-31GHz, with a RMS phase error of 5° and 9dB of insertion loss.

With a small footprint, good phase resolution and ability to switch between transmit and receive paths, the QPC1000 gives the system designer a small, highly functional block that is easily integrated into a higher level assembly.

The QPC1000 is matched to 50Ω with DC blocking capacitors on all RF ports. Its functionality makes it an ideal choice for ka-band, phased-array communication systems.

Lead-free and RoHS compliant.

Evaluation boards are available upon request.



Product Features

- Frequency Range: 29 – 31 GHz
- 5-Bit Digital Phase Shifter and SPDT Switch
- 360° Coverage, LSB = 11.25°, MSB = 180°
- RMS Phase Error, cardinal states: 5°
- RMS Amplitude Error, cardinal states: 0.7 dB
- Insertion Loss: 9 dB
- Isolation: 30 dB
- Input Return Loss: 10 dB
- Output Return Loss: 15 dB
- Input Power handling: 20 dBm
- Voltages: $V_S = 5\text{ V}$, $V_{BIT} = 0/+5\text{ V}$, $V_{CTRL} = \pm 5\text{ V}$
- Package Dimensions: 6 x 5 x 1.72 mm

Performance is typical across frequency. Please reference electrical specification table and data plots for more details.

Block Diagram

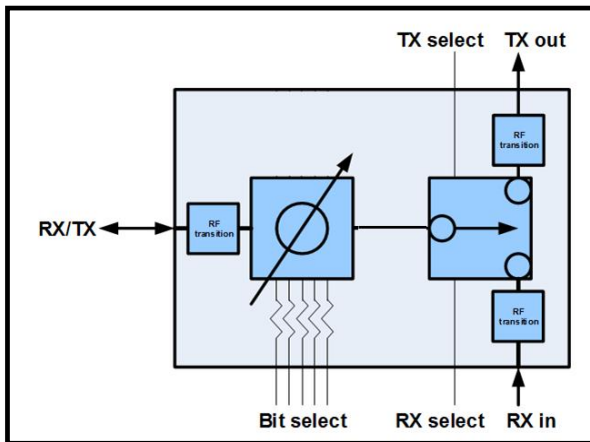

Applications

- Ka-band Satellite Communications

Ordering Information

Part No.	ECCN	Description
QPC1000	EAR99	29 – 31 GHz Phase Array

Electrical Specifications

Test conditions unless otherwise noted: 25 °C, $V_S = 5\text{ V}$, $V_{BIT} = 0/+5\text{ V}$, $V_{CTRL} = \pm 5\text{ V}$

Parameter	Min	Typ	Max	Units
Operational Frequency Range	29	–	31	GHz
RMS Phase Error	Cardinal states	5		degree
	All phase states	10		
RMS Amplitude Error	Cardinal states	0.6		dB
	All phase states	1.1		
Insertion Loss, S21		9		dB
Isolation, S31		30		dB
Input Return Loss – Common Port RL, S11		10		dB
Output Return Loss – Switched Port RL, S22		15		dB
Output Return Loss – Isolated Port RL, S33		3		dB
Input Power Handling, P_{IN}		20		dBm
MTBF ($T_{CH} \leq 150\text{ }^\circ\text{C}$, $P_{IN} \leq 20\text{ dBm}$)	20,000			hours

Recommended Operating Conditions

Parameter	Value / Range
Supply Voltage (V_S)	+5 V
Phase Bit Voltage (V_{BIT})	0/+5 V
Switch Control Voltage (V_{CTRL})	$\pm 5\text{ V}$
Supply Current (I_S)	100 μA typical
Phase Bit Current (I_S , I_{BIT})	$\pm 100\text{ }\mu\text{A}$ typical
Switch Control Current (I_{CTRL})	-20 mA / +100 μA typical
Temperature (T_{BASE})	-40 °C to 85 °C

Electrical specifications are measured at specified test conditions.

Specifications are not guaranteed over all recommended operating conditions.

Performance Plots – Small Signal

RMS Phase Error vs. Frequency vs. Temp.
Vs = 5 V

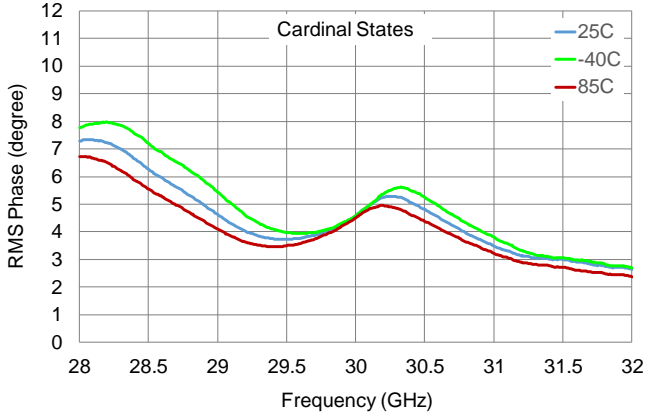

RMS Phase Error vs. Frequency vs. Temp.
Vs = 5 V

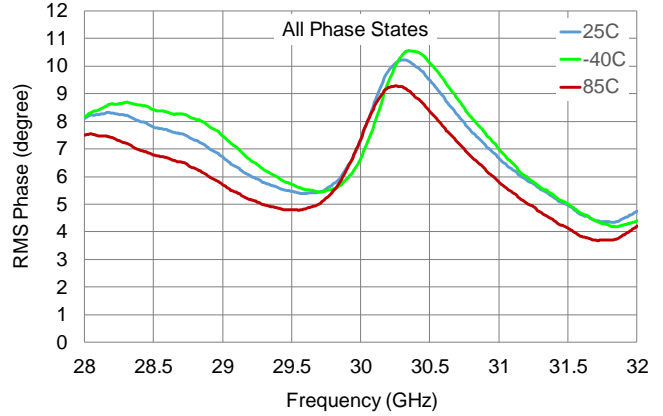

RMS Amplitude Error vs. Frequency vs. Temp.
Vs = 5 V

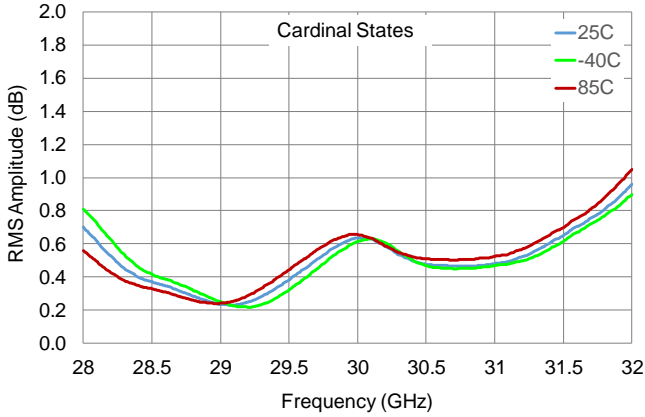

RMS Amplitude Error vs. Frequency vs. Temp.
Vs = 5 V

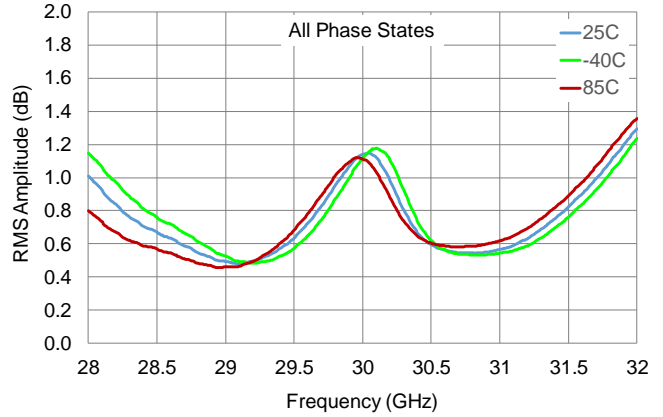

Performance Plots – Small Signal

Insertion Loss vs. Frequency vs. Temp.
Vs = 5 V, Average All Phase States

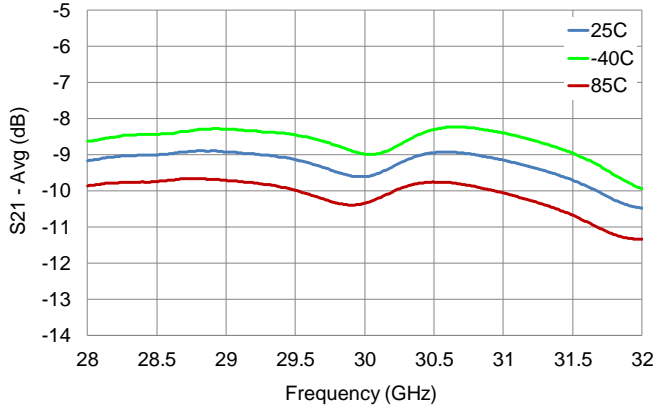

Insertion Loss vs. Frequency
Vs = 5 V, 25 °C, All Phase States

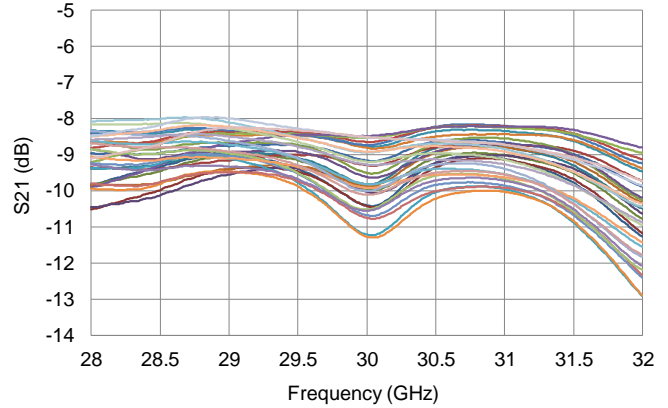

Isolation vs. Frequency vs. Temp.
Vs = 5 V, Average All Phase States

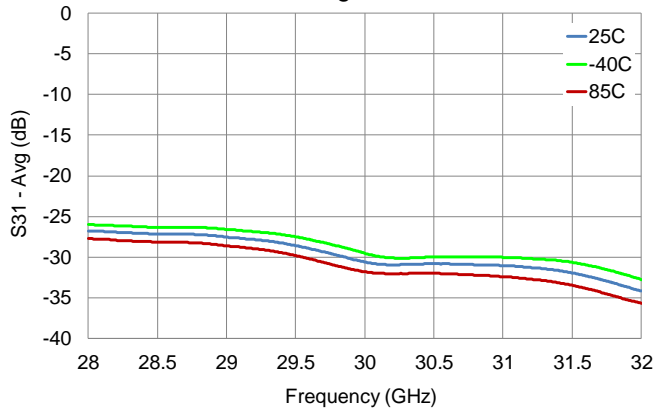

Isolation vs. Frequency
Vs = 5 V, 25 °C, All Phase States

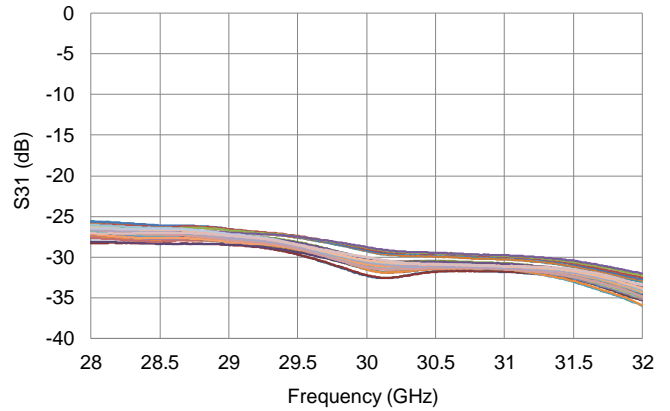

IL and Isolation vs. Frequency vs. RF Out Path
Vs = 5 V, 25 °C, Average All States

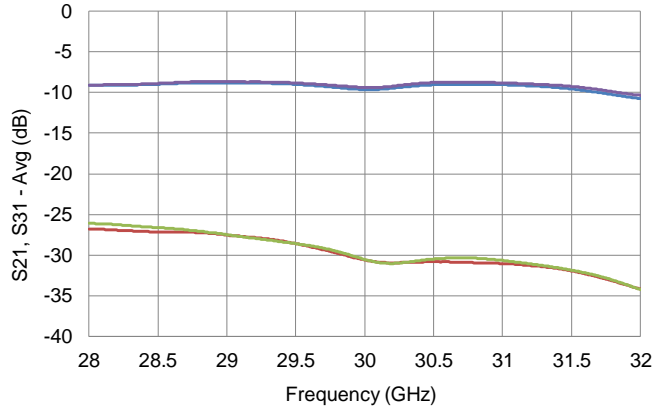

IL and Isolation vs. Frequency vs. RF Out Path
Vs = 5 V, 25 °C

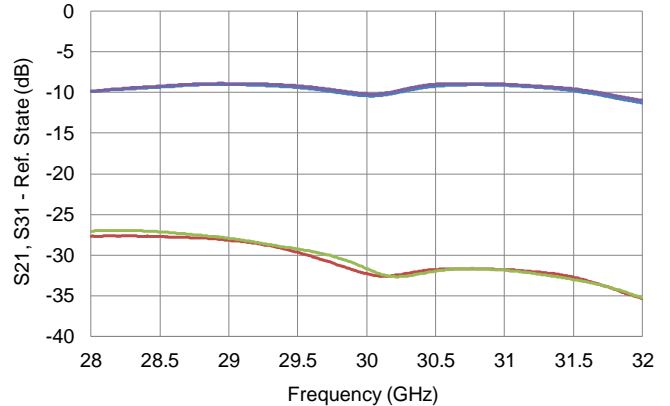

Performance Plots – Small Signal

Input Return Loss vs. Frequency vs. Temp.
Vs = 5 V, Average All Phase States

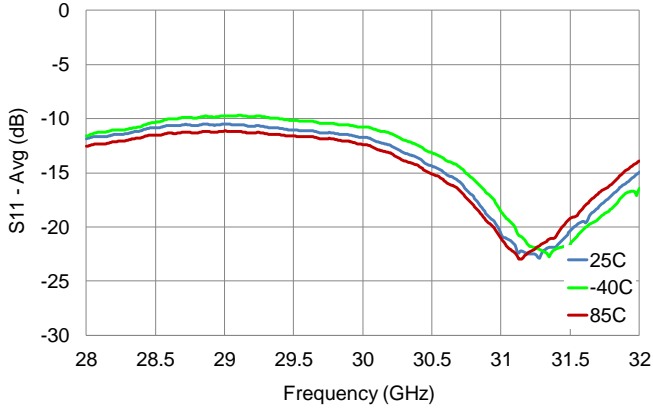

Input Return Loss vs. Frequency
Vs = 5 V, 25 °C, All Phase States

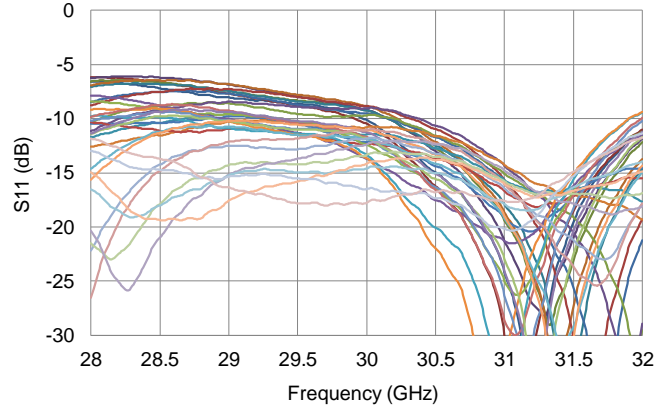

Output Return Loss vs. Frequency vs. Temp.
Vs = 5 V, Average All Phase States

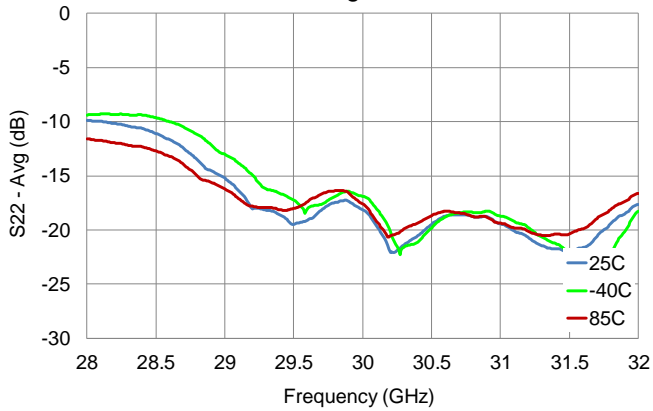

Output Return Loss vs. Frequency
Vs = 5 V, 25 °C, All Phase States

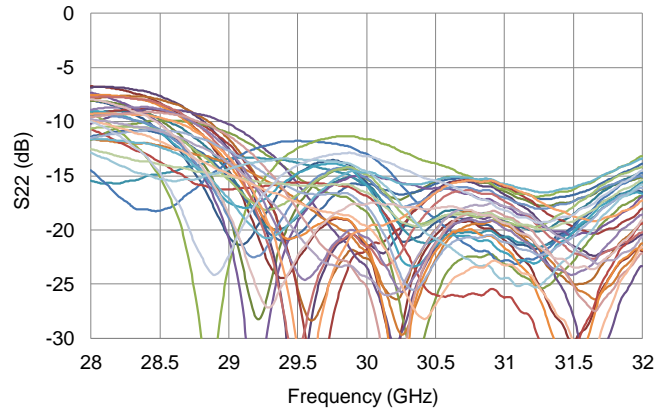

Output Return Loss vs. Frequency vs. Temp.
Vs = 5 V, Average All Phase States

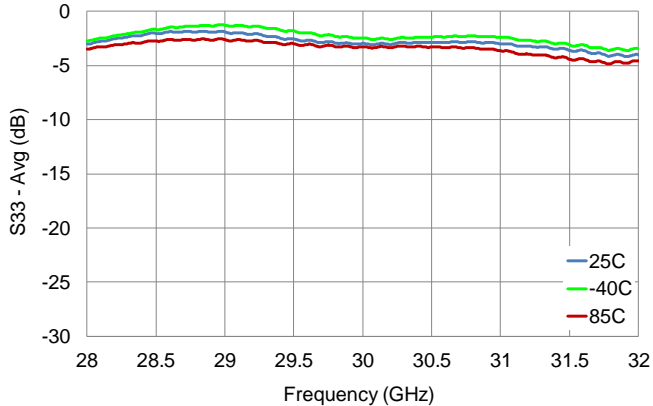

Output Return Loss vs. Frequency
Vs = 5 V, 25 °C, All Phase States

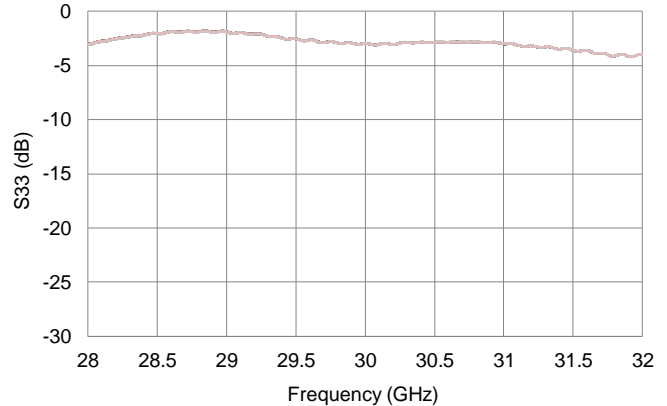

Performance Plots – Large Signal

RMS Phase Error vs. Frequency
 $V_s = 5\text{ V}$, $P_{in} = 20\text{ dBm}$, $25\text{ }^\circ\text{C}$

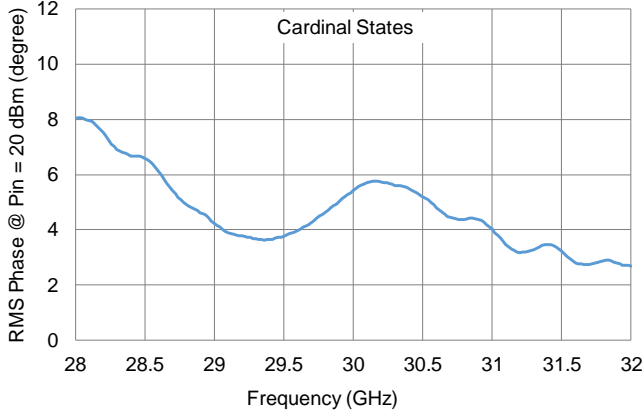

RMS Phase Error vs. Frequency
 $V_s = 5\text{ V}$, $P_{in} = 20\text{ dBm}$, $25\text{ }^\circ\text{C}$

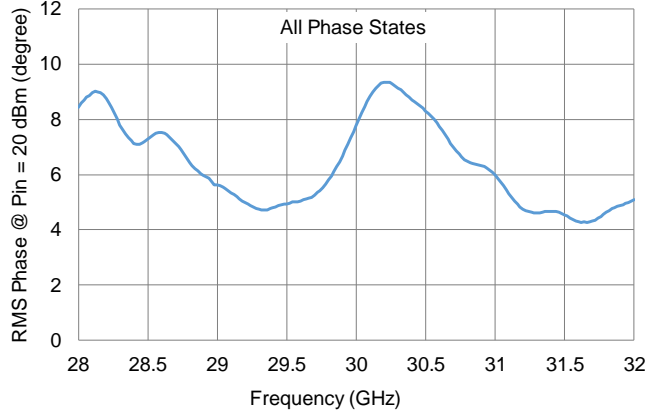

RMS Amplitude Error vs. Frequency
 $V_s = 5\text{ V}$, $P_{in} = 20\text{ dBm}$, $25\text{ }^\circ\text{C}$

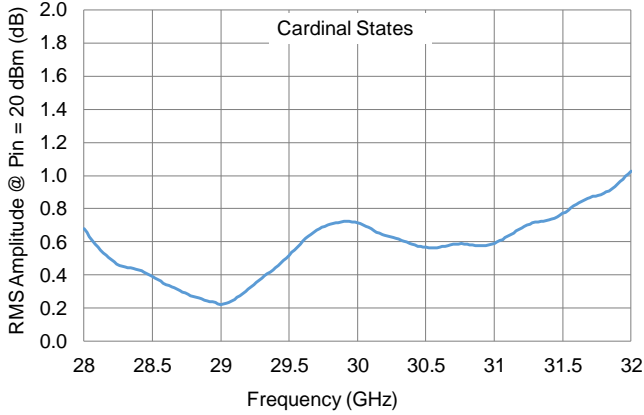

RMS Amplitude Error vs. Frequency
 $V_s = 5\text{ V}$, $P_{in} = 20\text{ dBm}$, $25\text{ }^\circ\text{C}$

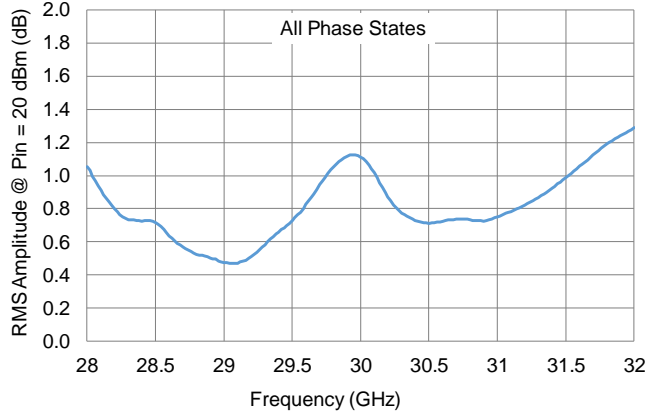

Performance Plots – Linearity

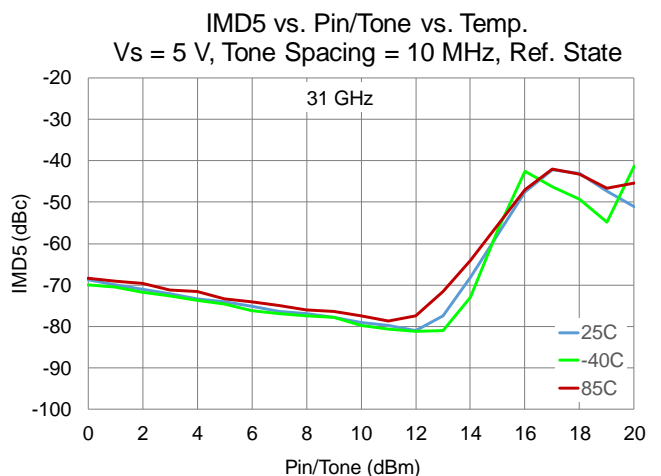
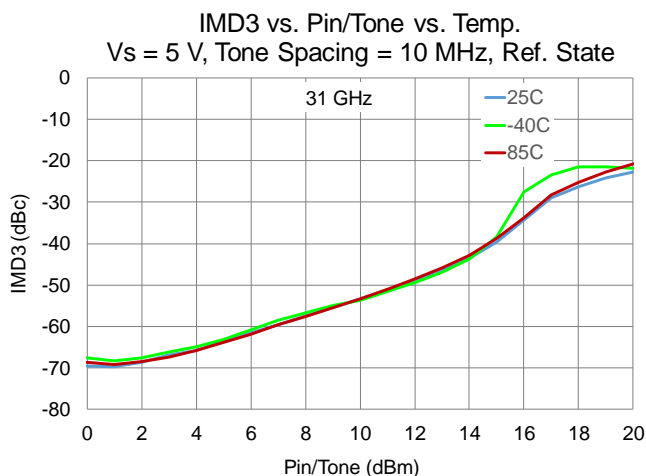
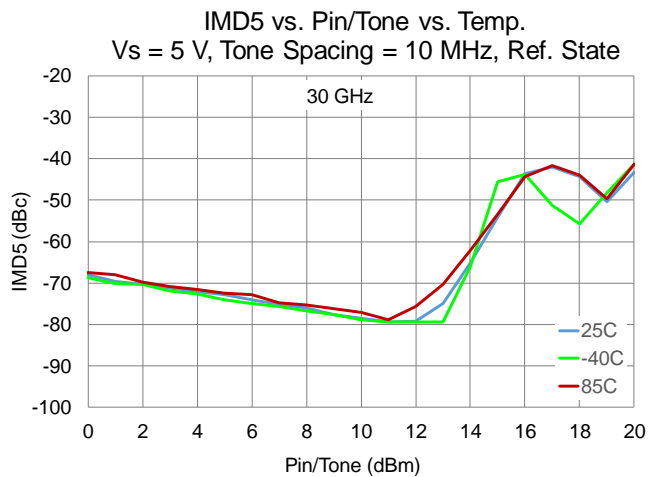
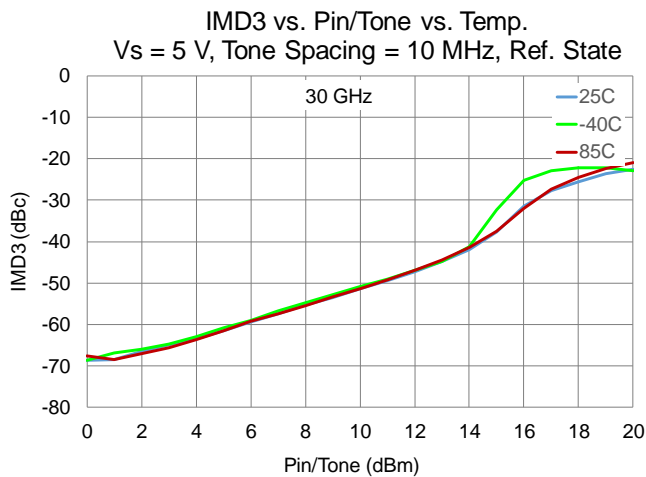
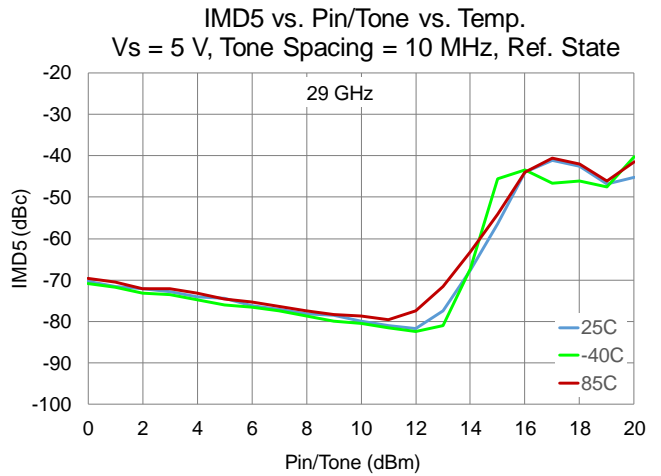
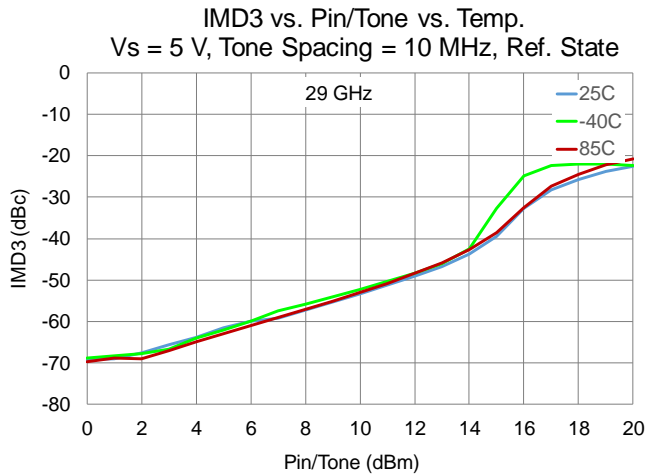

Applications Circuit

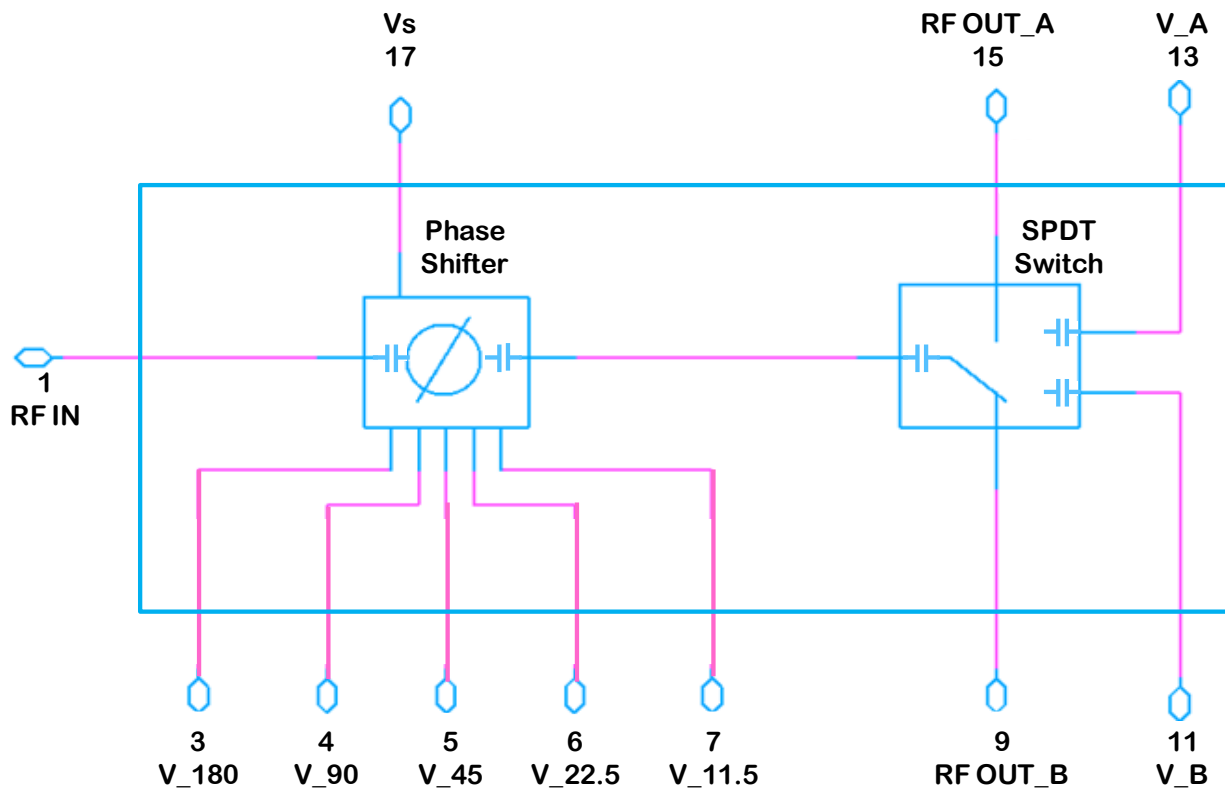

Bias Truth Table

Logic "0" = 0 V, Logic "1" = +5 V, $V_{CTRL} = \pm 5 V$

Phase Shifter / V_{BIT}	$V_{11.5}$	$V_{22.5}$	V_{45}	V_{90}	V_{180}	V_s	V_A	V_B
0° (Reference)	0	0	0	0	0	1	See V_{CTRL}	
11.5°	1	0	0	0	0	1		
22.5°	0	1	0	0	0	1		
45°	0	0	1	0	0	1		
90°	0	0	0	1	0	1		
180°	0	0	0	0	1	1		

RF Out Port / V_{CTRL}	V_A	V_B
RF OUT_A	+5V	-5V
RF OUT_B	-5V	+5V

Pin Description

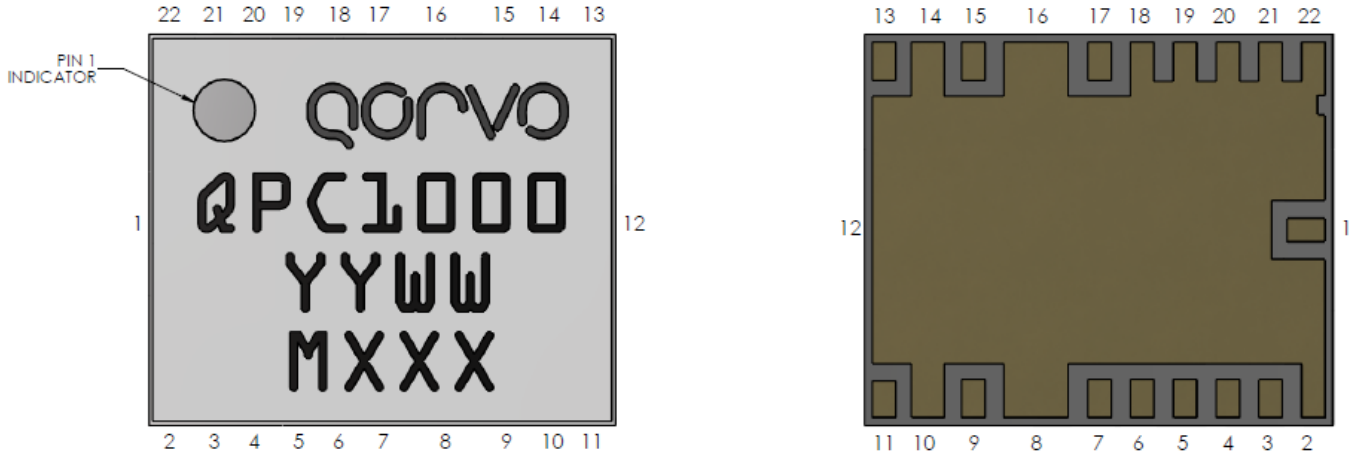

Pin Description

Pin No.	Symbol	Description
1	RF IN	RF Input, 50 Ω, DC blocked
2, 8, 10, 12, 14, 16, 18 - 22	GND	Internal grounding and shielding, must be grounded on PCB
3	V_180	180° Phase Bit Voltage
4	V_90	90° Phase Bit Voltage
5	V_45	45° Phase Bit Voltage
6	V_22.5	22.5° Phase Bit Voltage
7	V_11.5	11.5° Bit Voltage
9	RF OUT_B	RF Output_B, 50 Ω, DC blocked
11	V_B	Switch Control Voltage
13	V_A	Switch Control Voltage
15	RF OUT_A	RF Output_A, 50 Ω, DC blocked
17	V _s	Supply Voltage
23	GND	Backside Paddle; multiple vias should be used on PCB to minimize inductance and thermal resistance

Evaluation Board (EVB) Layout Assembly

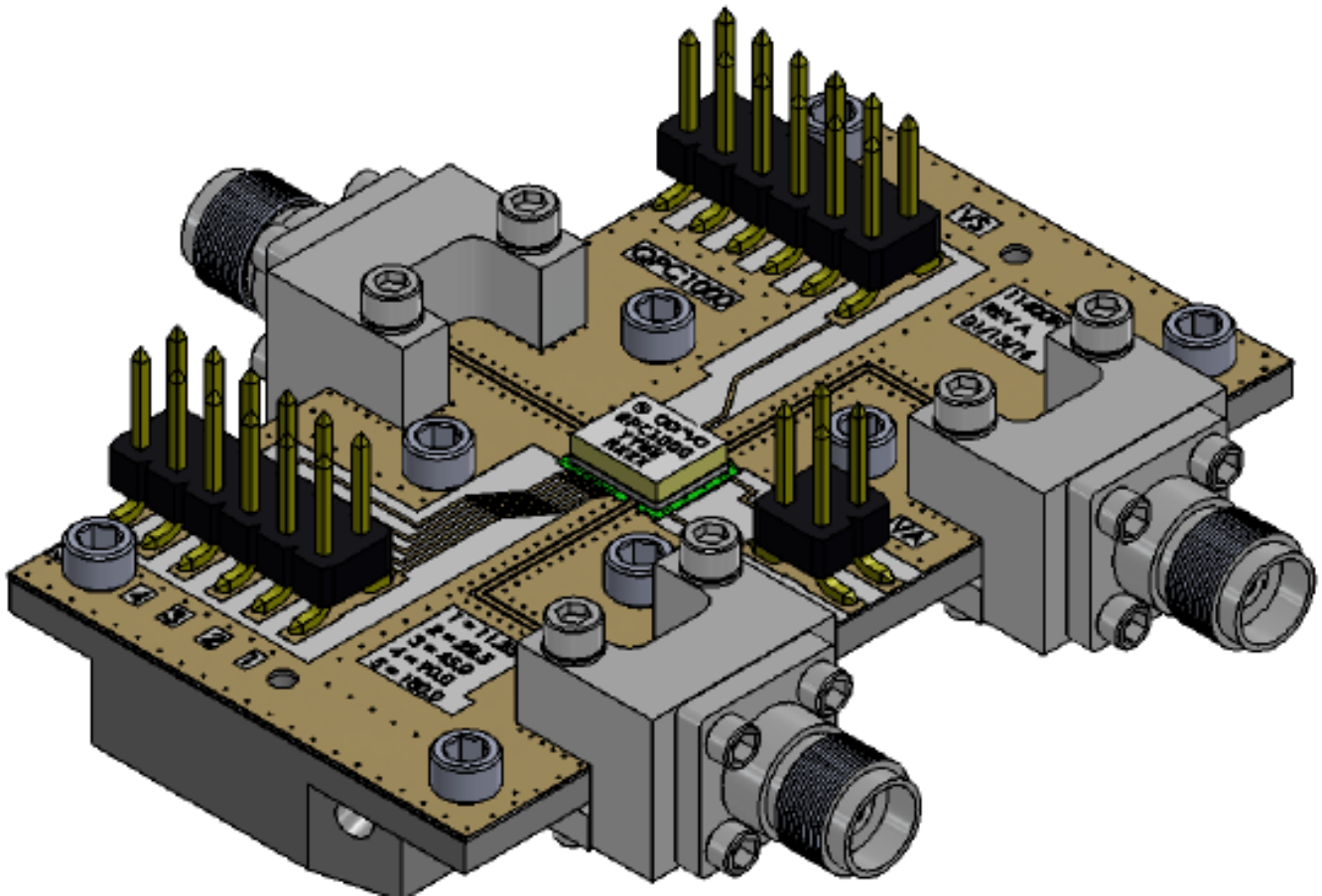

Mechanical Information

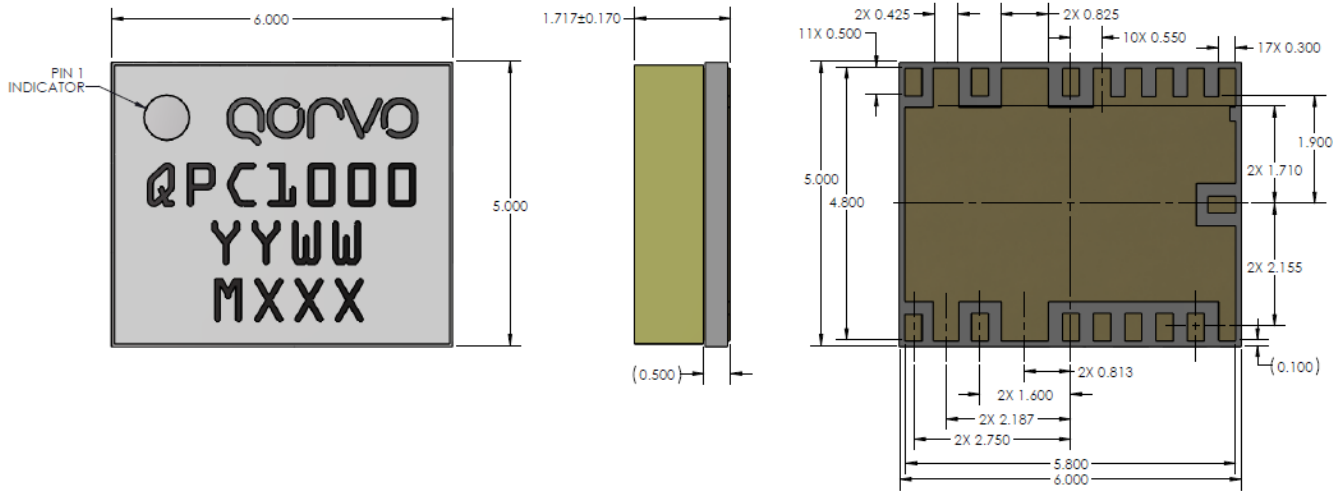

Units: Millimeter (mm)

Tolerances: unless specified

x.xx = ± 0.25

x.xxx = ± 0.100

Materials:

Base: EHS Laminate

Lid: Laminate

All metalized features are gold plated

Part is epoxy sealed

Marking:

QPC1000: Part number

YY: Part Assembly year

WW: Part Assembly week

MXXX: Lot Number

Absolute Maximum Ratings

Parameter	Value / Range
Supply Voltage (V_S)	+8 V
Phase Bit Voltage (V_{BIT})	0 / +8 V
Switch Control Voltage (V_{CTRL})	± 5 V
Phase Bit Current (I_S, I_{BIT})	5 mA
Switch Control Current (I_{CTRL})	30 mA
Input Power, CW, 50 Ω , 85°C (P_{IN})	20 dBm
Channel Temperature (T_{CH})	200 °C
Mounting Temperature (30 Seconds)	260 °C
Storage Temperature	-55 to 150 °C

Operation of this device outside the parameter ranges given above may cause permanent damage. These are stress ratings only, and functional operation of the device at these conditions is not implied.

Recommended Soldering Temperature Profile

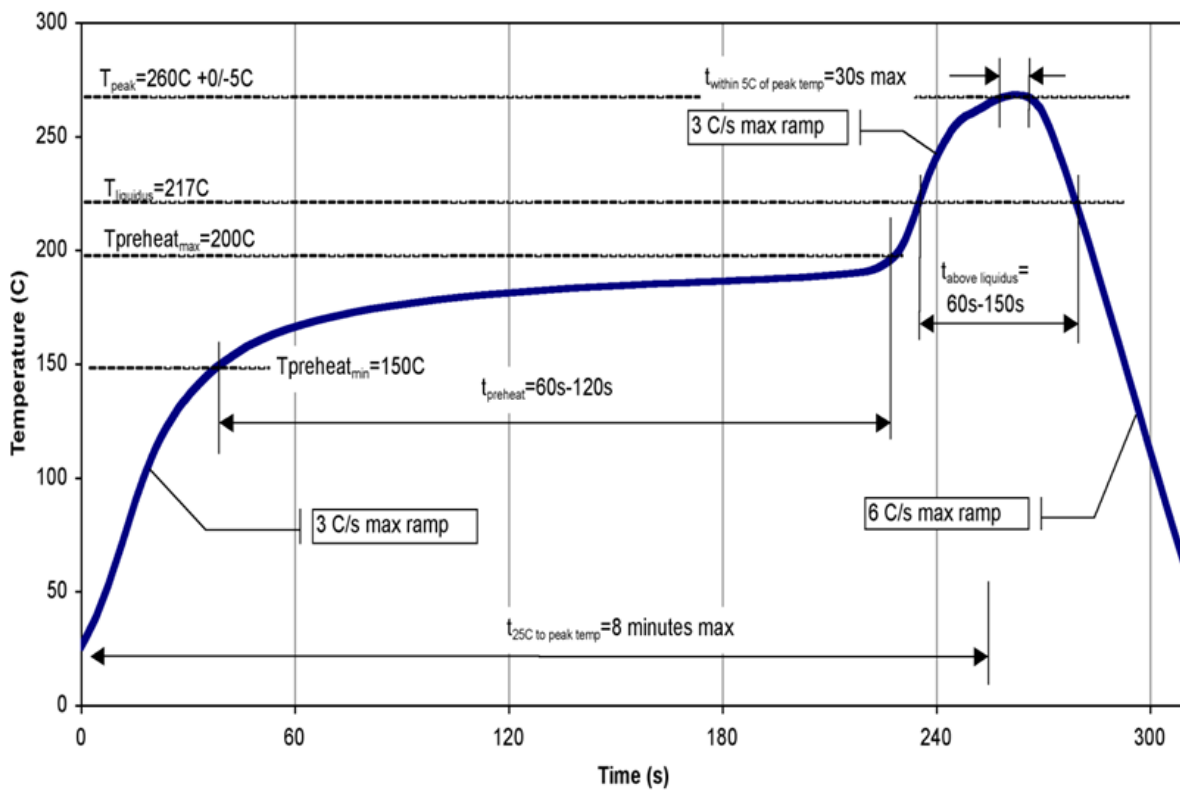

Handling Precautions

Parameter	Rating	Standard
ESD – Human Body Model (HBM)	TBD	ESDA / JEDEC JS-001-2012
MSL – Moisture Sensitivity Level	TBD	IPC/JEDEC J-STD-020



Caution!
ESD-Sensitive Device

Solderability

Compatible with both lead-free (260°C max. reflow temp.) and tin/lead (245°C max. reflow temp.) soldering processes. Solder profiles available upon request.

RoHS Compliance

This product is compliant with the 2011/65/EU RoHS directive (Restrictions on the Use of Certain Hazardous Substances in Electrical and Electronic Equipment), as amended by Directive 2015/863/EU. This product also has the following attributes:

- Lead Free
- Antimony Free
- TBBP-A (C₁₅H₁₂Br₄O₂) Free
- PFOS Free
- SVHC Free
- Qorvo Green



Contact Information

For the latest specifications, additional product information, worldwide sales and distribution locations:

Tel: 1-844-890-8163

Web: www.qorvo.com

Email: customer.support@qorvo.com

For technical questions and application information: **Email:** appsupport@qorvo.com

Important Notice

The information contained herein is believed to be reliable; however, Qorvo makes no warranties regarding the information contained herein and assumes no responsibility or liability whatsoever for the use of the information contained herein. All information contained herein is subject to change without notice. Customers should obtain and verify the latest relevant information before placing orders for Qorvo products. The information contained herein or any use of such information does not grant, explicitly or implicitly, to any party any patent rights, licenses, or any other intellectual property rights, whether with regard to such information itself or anything described by such information. **THIS INFORMATION DOES NOT CONSTITUTE A WARRANTY WITH RESPECT TO THE PRODUCTS DESCRIBED HEREIN, AND QORVO HEREBY DISCLAIMS ANY AND ALL WARRANTIES WITH RESPECT TO SUCH PRODUCTS WHETHER EXPRESS OR IMPLIED BY LAW, COURSE OF DEALING, COURSE OF PERFORMANCE, USAGE OF TRADE OR OTHERWISE, INCLUDING THE IMPLIED WARRANTIES OF MERCHANTABILITY AND FITNESS FOR A PARTICULAR PURPOSE.**

Without limiting the generality of the foregoing, Qorvo products are not warranted or authorized for use as critical components in medical, life-saving, or life-sustaining applications, or other applications where a failure would reasonably be expected to cause severe personal injury or death.

Copyright 2016 © Qorvo, Inc. | Qorvo is a registered trademark of Qorvo, Inc.