

Product Overview

The QPC6762 is a 75Ω Silicon on Insulator (SOI) single-pole, six throw (SP6T) switch designed for use in CATV, satellite set top, and other high-performance communications systems. It offers a high isolation symmetric topology with excellent linearity and power handling capability. No blocking caps are necessary on the RF ports. QPC6762 is packaged in a convenient 2.0mm x 2.0mm QFN package

Functional Block Diagram

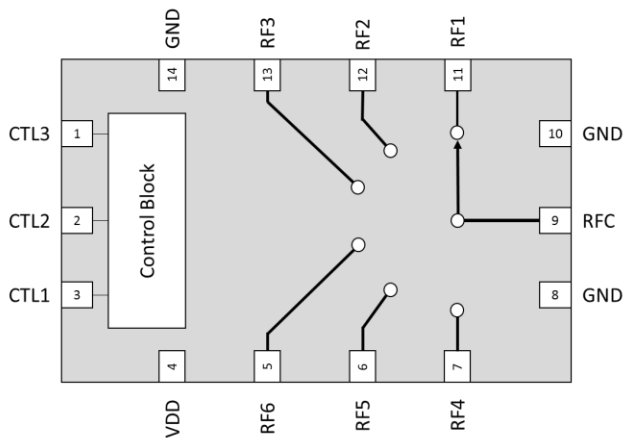

Top View

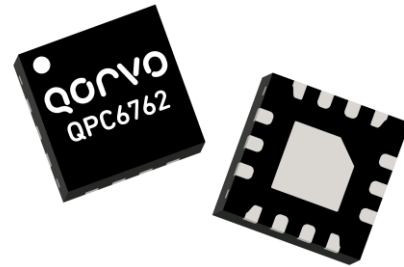

14 Pin 2.0 x 2.0mm QFN Package

Key Features

- 5MHz to 2000MHz Operation
- Low Insertion Loss: 0.4dB at 800MHz
- No Blocking Caps Required Unless Voltage on RF Line
- High Isolation: 34dB at 800MHz
- High Input IP3: 75dBm at 850MHz
- 2kV ESD
- +1.8V Logic Compatible
- 3V to 5V Operation

Applications

- MDU Amplifiers
- Point To Point
- Optical Nodes
- Set Top Box
- PCTV
- Multi-tuner DVR

Ordering Information

| Part No. | Description |
|------------|--|
| QPC6762SQ | Sample bag with 25 pieces |
| QPC6762SR | 7" Reel with 100 pieces |
| QPC6762TR7 | 7" Reel with 2500 pieces |
| QPC6762PCK | 5 – 2000MHz PCBA with 5 pc. sample bag |

Absolute Maximum Ratings

| Parameter | Rating |
|---|---------------|
| Control Voltage (V_{CTL}) | 3.0V |
| Supply Voltage (V_{DD}) | 6.0V |
| Maximum CW Input Power at 25°C | 32dBm |
| Max Input Power During Active Switching | 24dBm |
| Storage Temperature Range | -40 to +150°C |

Exceeding any one or a combination of the Absolute Maximum Rating conditions may cause permanent damage to the device. Extended application of Absolute Maximum Rating conditions to the device may reduce device reliability.

Recommended Operating Conditions

| Parameter | Min | Typ | Max | Units |
|--------------------------|-----|-----|-----|-------|
| Supply Voltage, V_{DD} | 2.7 | 5 | 5.5 | V |
| Temperature Range | -40 | | 85 | °C |

Electrical specifications are measured at specified test conditions. Specifications are not guaranteed over all recommended operating conditions.

Electrical Specifications

| Parameter | Conditions ⁽¹⁾ | Min | Typ | Max | Units |
|--------------------------------|---------------------------|-----|------|------|-------|
| Frequency Range | | 5 | | 2000 | MHz |
| Insertion Loss (RFC to RFX) | 5MHz | | 0.28 | | dB |
| | 50MHz | | 0.32 | | |
| | 800MHz | | 0.40 | | |
| | 1.2GHz | | 0.43 | | |
| | 2GHz | | 0.52 | | |
| Isolation (RFC to RFX) | 5MHz | | 50 | | dB |
| | 50MHz | | 60 | | |
| | 800MHz | | 34 | | |
| | 1.2GHz | | 28 | | |
| | 2GHz | | 23 | | |
| Isolation (RFX) | 5MHz | | 55 | | dB |
| | 50MHz | | 53 | | |
| | 800MHz | | 24 | | |
| | 1.2GHz | | 25 | | |
| | 2GHz | | 17 | | |
| Return Loss (RFC) | 5MHz | | 48 | | dB |
| | 50MHz | | 36 | | |
| | 800MHz | | 19 | | |
| | 1.2GHz | | 23 | | |
| | 2GHz | | 15 | | |

Notes:

1. Test Conditions Unless Otherwise Specified: $T_A = +25^\circ\text{C}$, $V_{DD} = +5\text{V}$, $V_{CTL} = 0/+2.5\text{V}$, 75Ω system.

Electrical Specifications (cont'd.)

| Parameter | Conditions ⁽¹⁾ | Min | Typ | Max | Units |
|-------------------------------|--|-----|------|-----|-------|
| Input IP3 | 850MHz +12dBm input power per tone, 30MHz tone spacing | | 75 | | dBm |
| Input IP2 | 850MHz +12dBm input power per tone, 30MHz tone spacing | | 121 | | |
| Input 1dB Compression Point | 850MHz | | 37 | | |
| Input 0.1dB Compression Point | 850MHz | | 33 | | |
| MER | 75dBmV composite at 885MHz | | 41.1 | | dB |
| CCN | 75dBmV composite at 885MHz | | 55.8 | | |
| Switching Speed | 10/90% RF | | 0.35 | | μs |
| Switching Speed | 50% control to 10/90% RF | | 1.8 | | |
| Turn On Time | Time for VDD = 0V to part ON and RF = 90% | | 20 | | |
| NVG Spurs | 5 - 30MHz | | -117 | | dBm |
| Harmonics-2nd | 5 MHz | | -72 | | dBc |
| | 50MHz | | -76 | | |
| | 850MHz | | -130 | | |
| | 1800MHz | | -110 | | |
| Harmonics-3rd | 5MHz | | -93 | | dBc |
| | 50MHz | | -102 | | |
| | 850MHz | | -117 | | |
| | 1800MHz | | -106 | | |

Notes:

1. Test Conditions Unless Otherwise Specified: T_A = +25°C, V_{DD} = +5V, V_{CTL} = 0/+2.5V, 75Ω system. Drive RFC, RFx output.

Electrical Specifications - Power Supply

| Parameter | Conditions ⁽¹⁾ | Min | Typ | Max | Units |
|-----------------------------------|---------------------------|-----|-----|------|-------|
| Supply Current (I _{DD}) | V _{DD} = +5.0V | | 65 | 120 | μA |
| Control Current | CTL1, CTL2, CTL3 | | | 5 | μA |
| Control Voltage High | | 1.3 | | 2.7 | V |
| Control Voltage Low | | 0 | | 0.45 | V |

Power Supply Sequencing Requirements

| Condition | Sequence |
|------------|--|
| Power Up | Turn on VDD, then CTL1, CTL2, and CTL3, then (20μs or greater) apply RF signal |
| Power Down | Turn off RF signal, then CTL1, CTL2, and CTL3, then turn off VDD |

Truth Table

| Mode | Control Signals | | |
|------------|-----------------|------|------|
| | CTL1 | CTL2 | CTL3 |
| RFC to RF1 | High | Low | Low |
| RFC to RF2 | Low | High | Low |
| RFC to RF3 | High | High | Low |
| RFC to RF4 | Low | Low | High |
| RFC to RF5 | High | Low | High |
| RFC to RF6 | Low | High | High |

5-2000 MHz Evaluation Board Schematic (QPC6762PCK)

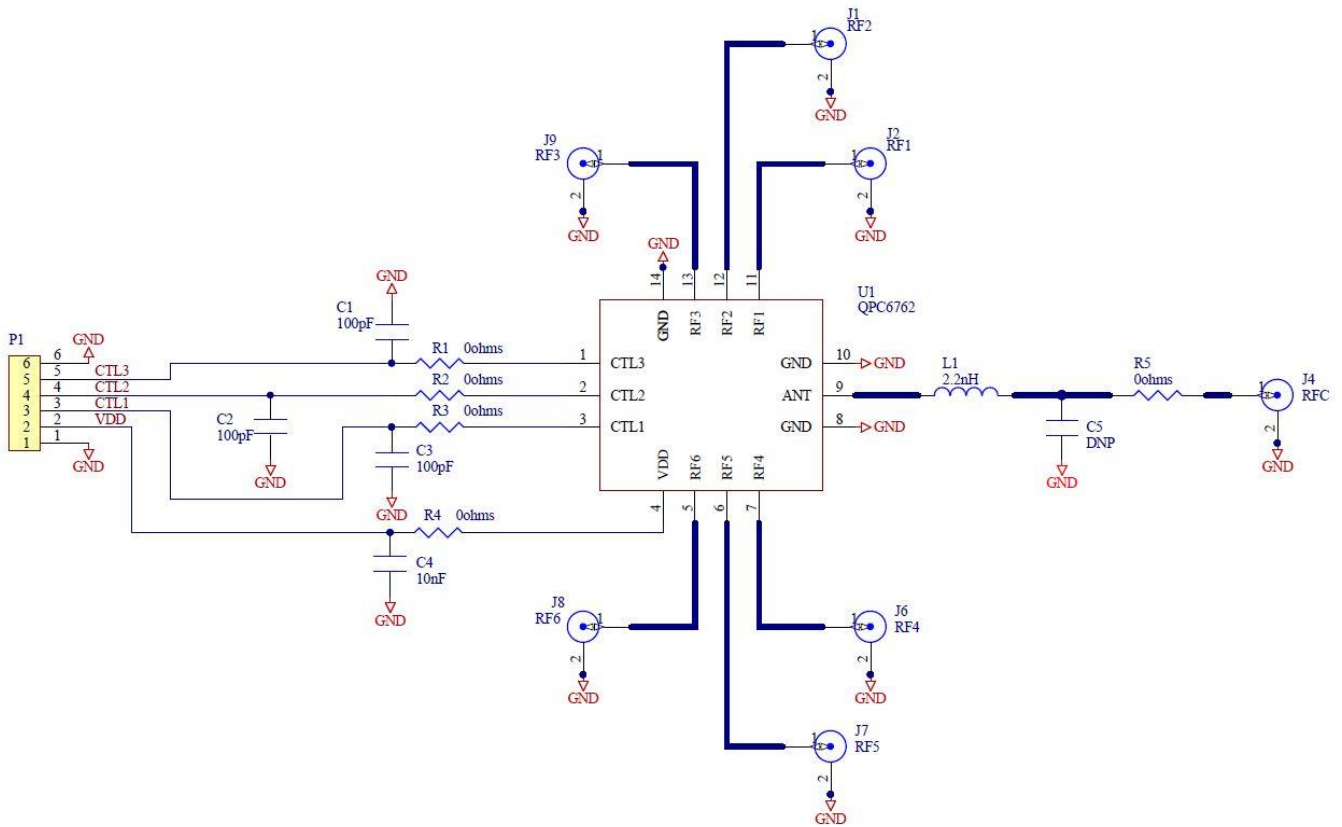

| Ref. Designator | Description | Manufacturer | Part Number |
|----------------------------|---------------------------------------|-----------------------|--------------------|
| PCB | Evaluation Board PCB | Viasystems | QPC6762-4000 |
| U1 | 75ohm SP6T Switch | Qorvo | QPC6762SB |
| J1, J2, J4, J6, J7, J8, J9 | F Connector, Edge Mount, 75 Ω, 0.065" | Genesis Technology | GT20-300204 |
| R1, R2, R3, R4 | 0 Ω RES, 0402 | Kamaya, Inc | RMC1/16SJPTH |
| R5 | 0 Ω RES, 50mohm max, 0402 | KOA Speer Electronics | RK73Z1ETTP |
| P1 | CONN, HDR, ST, PLRZD, 6-PIN, 0.100" | AMP | 640454-6 |
| C1, C2, C3 | CAP, 100pF, 5%, 50V, COG, 0402 | Murata | GRM1555C1H101JA01D |
| C4 | CAP, 10nF, 10%, 25V, X7R, 0402 | Murata | GRM155R71E103KA01D |
| L1 | IND, 2.2nH, +/-0.1nH, M/L, Hi-Q, 0201 | Taiyo Uden | LG HKQ0603W2N2B-T |
| C5 | DNP | N/A | N/A |

Evaluation Board Assembly (QPC6762PCK)

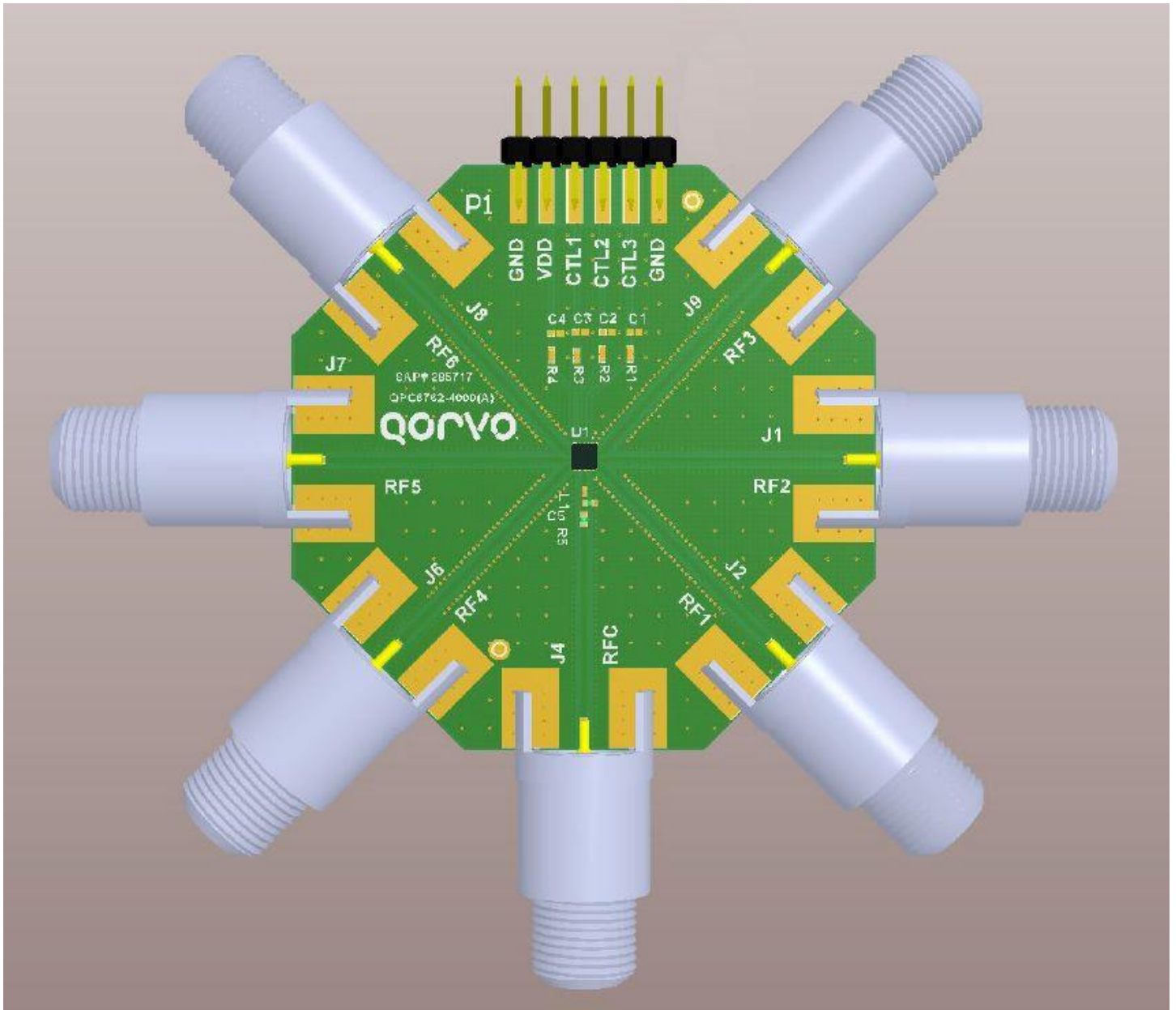

Performance Plots

Test conditions unless otherwise noted: $V_{DD} = +5V$, $V_{CTL} = 0 / 2.5V$, Temp = $+25^{\circ}C$, $Z_0 = 75\Omega$

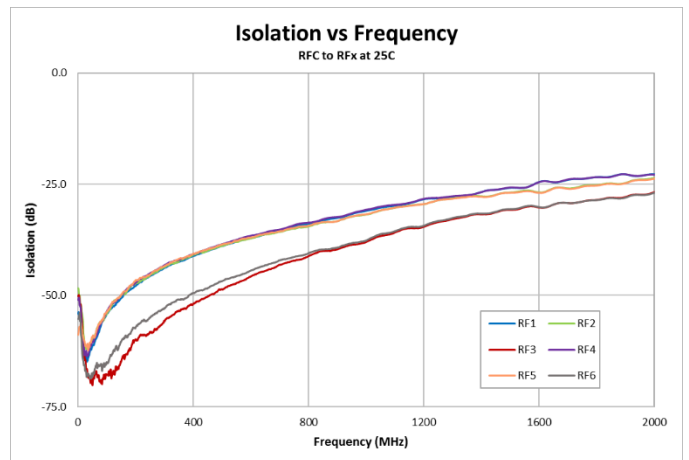
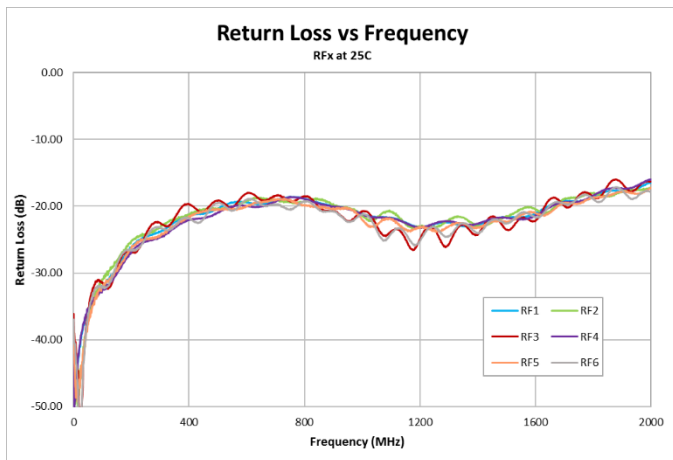
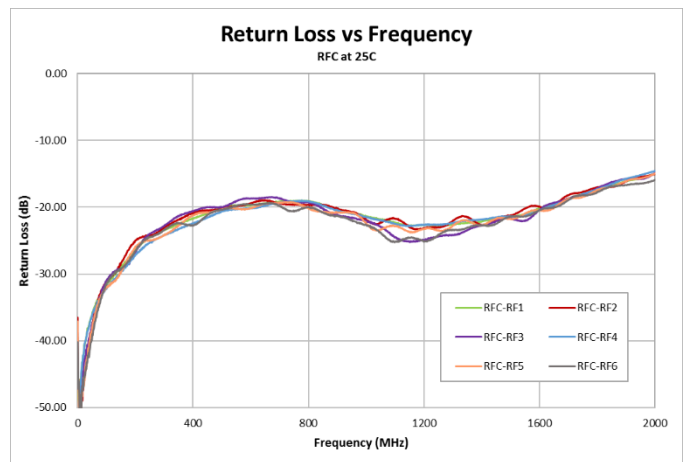
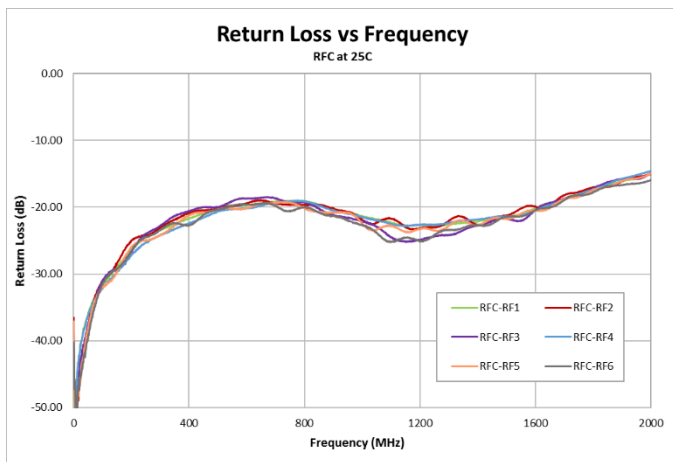
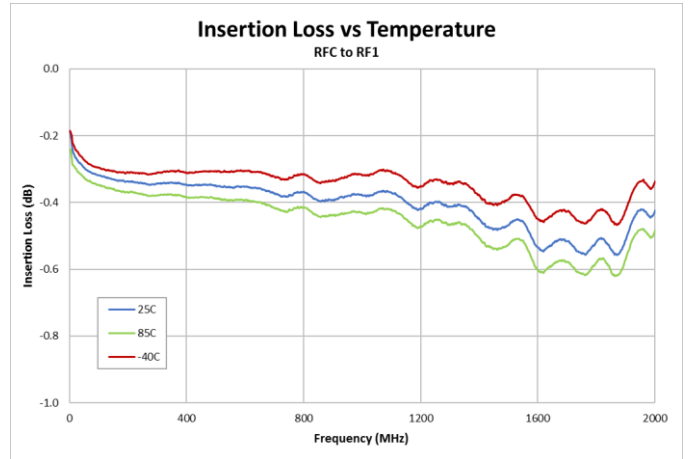
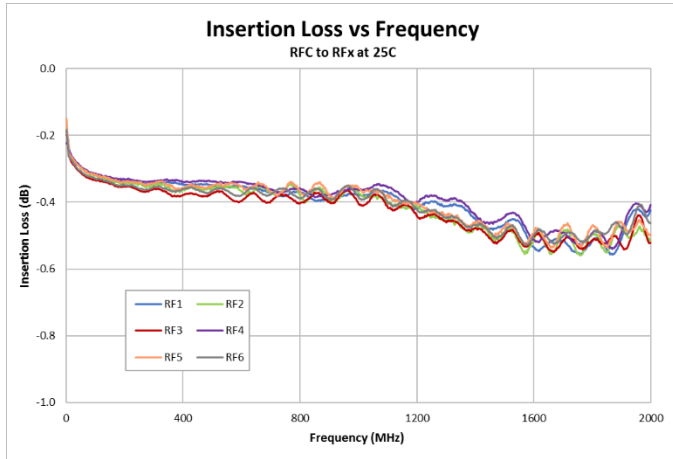

Notes:

1. Insertion Loss plots are loss compensated to remove effects of EVB.

Performance Plots (cont'd.)

Test conditions unless otherwise noted: $V_{DD} = +5V$, $V_{CTL} = 0 / 2.5V$, Temp = $+25^{\circ}C$, $Z_o = 75\Omega$

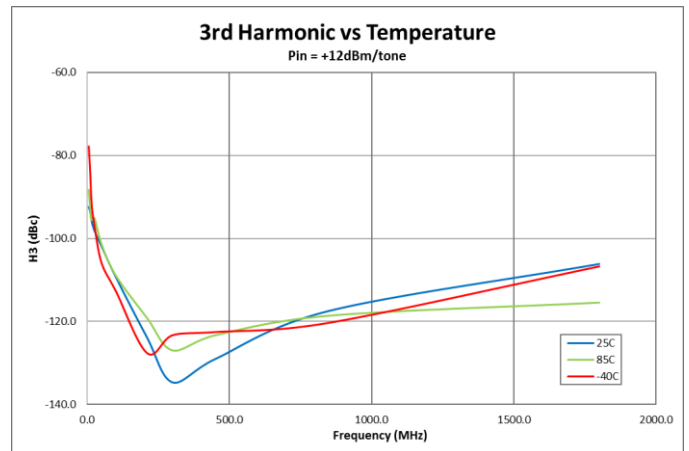
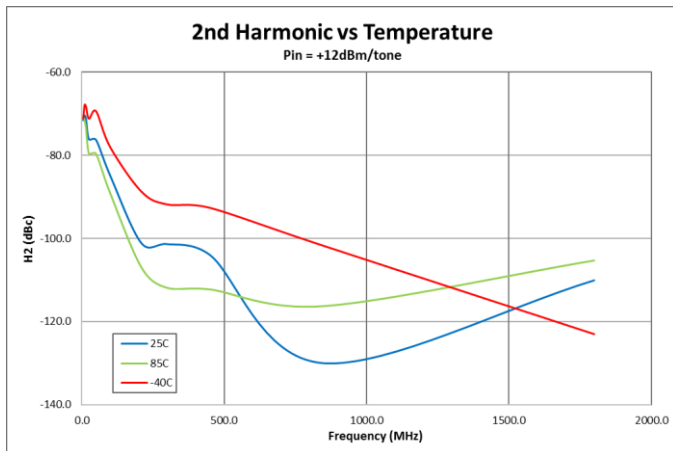
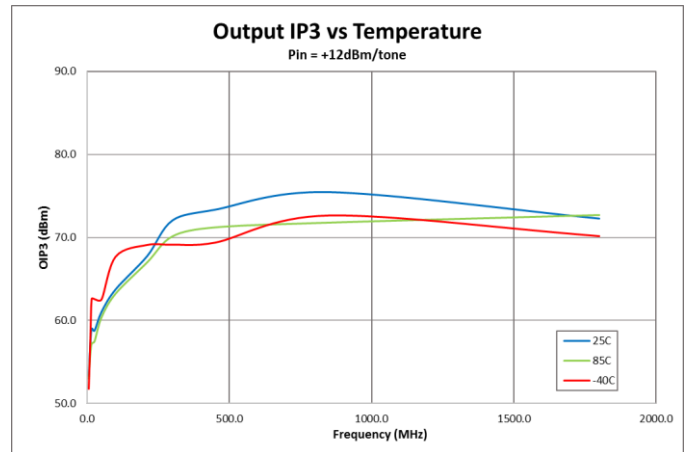
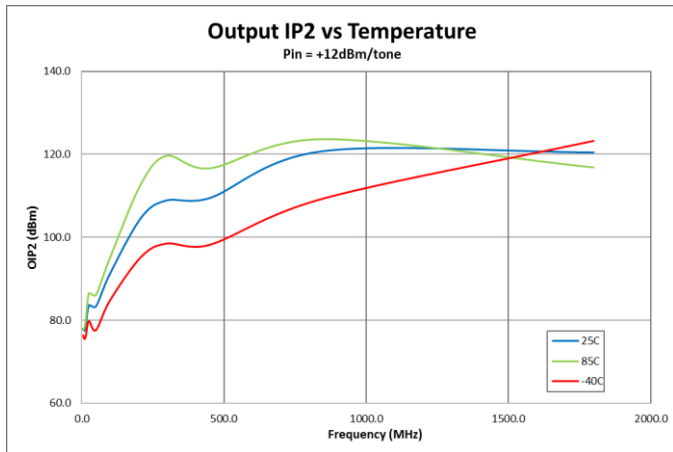
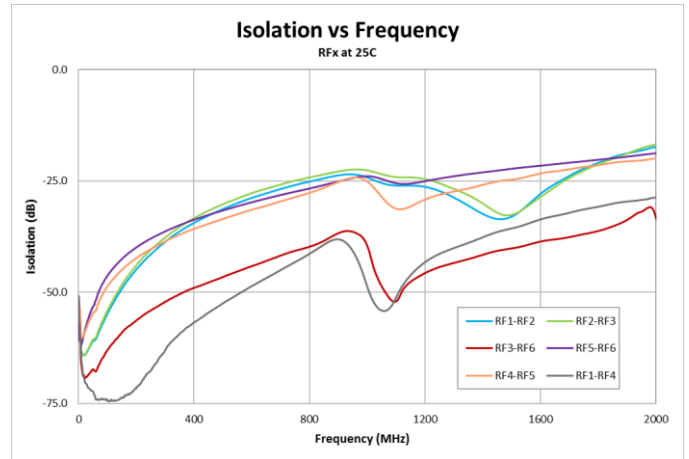
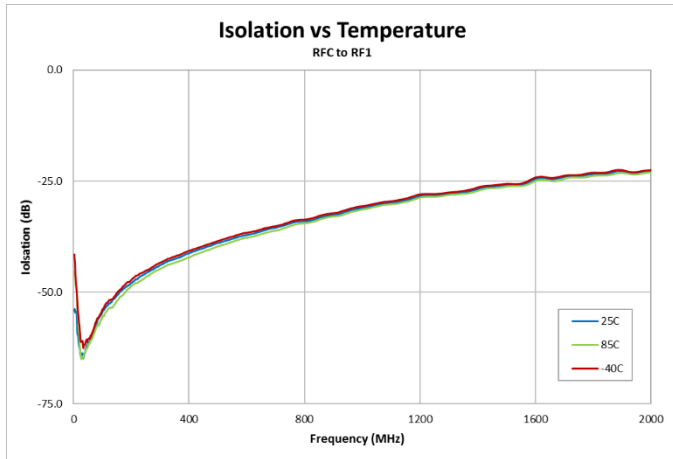

Performance Plots (cont'd.)

Test conditions unless otherwise noted: $V_{DD} = +5V$, $V_{CTL} = 0 / 2.5V$, Temp = $+25^{\circ}C$, $Z_0 = 75\Omega$

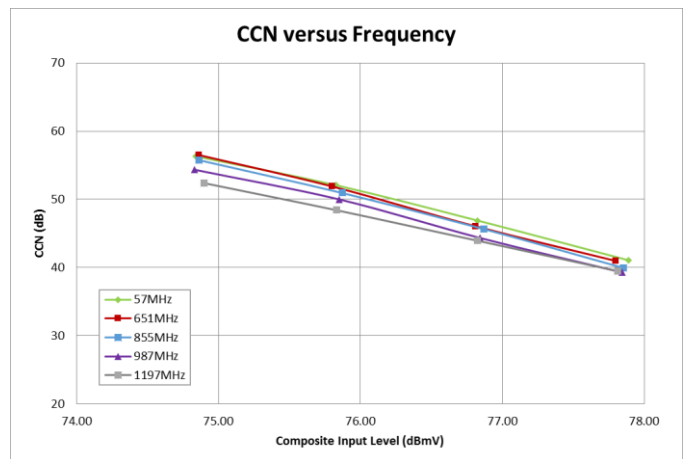
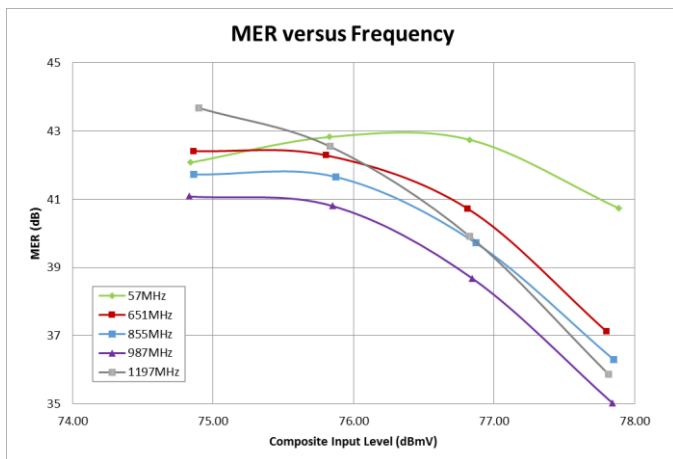
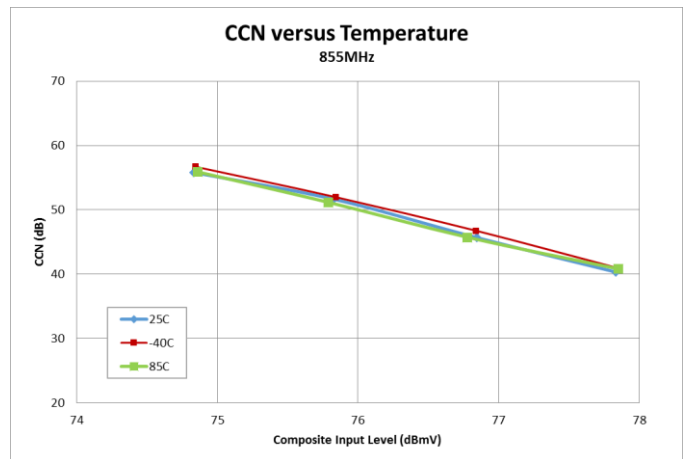
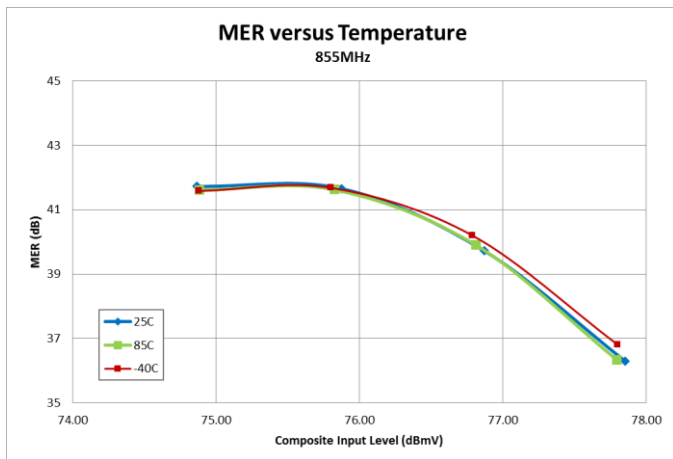
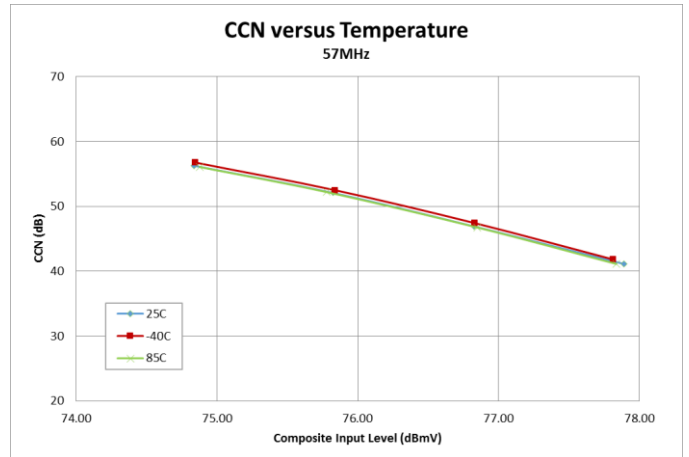
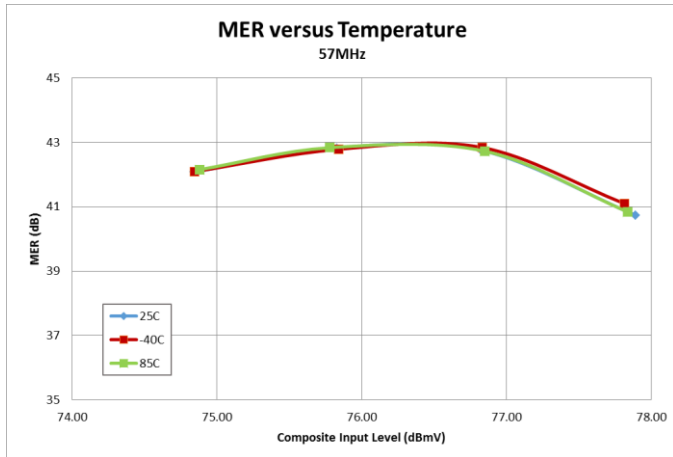

MER/CCN Test Conditions:

1. 190 QAM256 Channels, 57-1215MHz, ITU-T J.83, Annex B
2. CCN test procedure according to ANSI/SCTE 17. System BW 5.36MHz.

Pin Configuration and Description

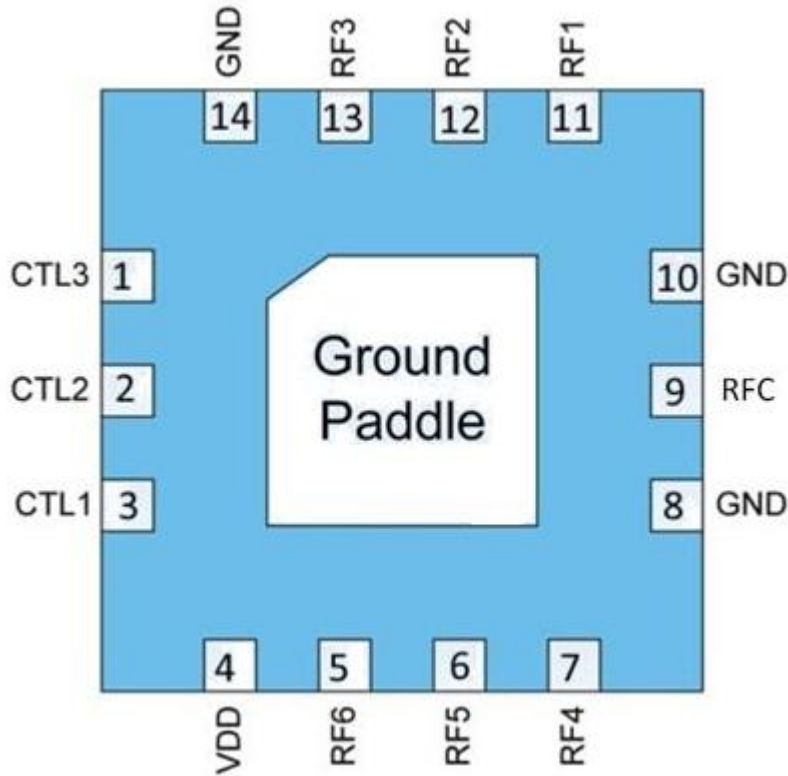

Top View

| Pad No. | Label | Description |
|---------|-------|------------------------|
| 1 | CTL3 | Switch Logic Control 3 |
| 2 | CTL2 | Switch Logic Control 2 |
| 3 | CTL1 | Switch Logic Control 1 |
| 4 | VDD | Supply Voltage |
| 5 | RF6 | RF Output Port |
| 6 | RF5 | RF Output Port |
| 7 | RF4 | RF Output Port |
| 8 | GND | Ground |
| 9 | RFC | RF Input Port |
| 10 | GND | Ground |
| 11 | RF1 | RF Output Port |
| 12 | RF2 | RF Output Port |
| 13 | RF3 | RF Output Port |
| 14 | GND | Ground |

Applications Schematic; 5-2000MHz

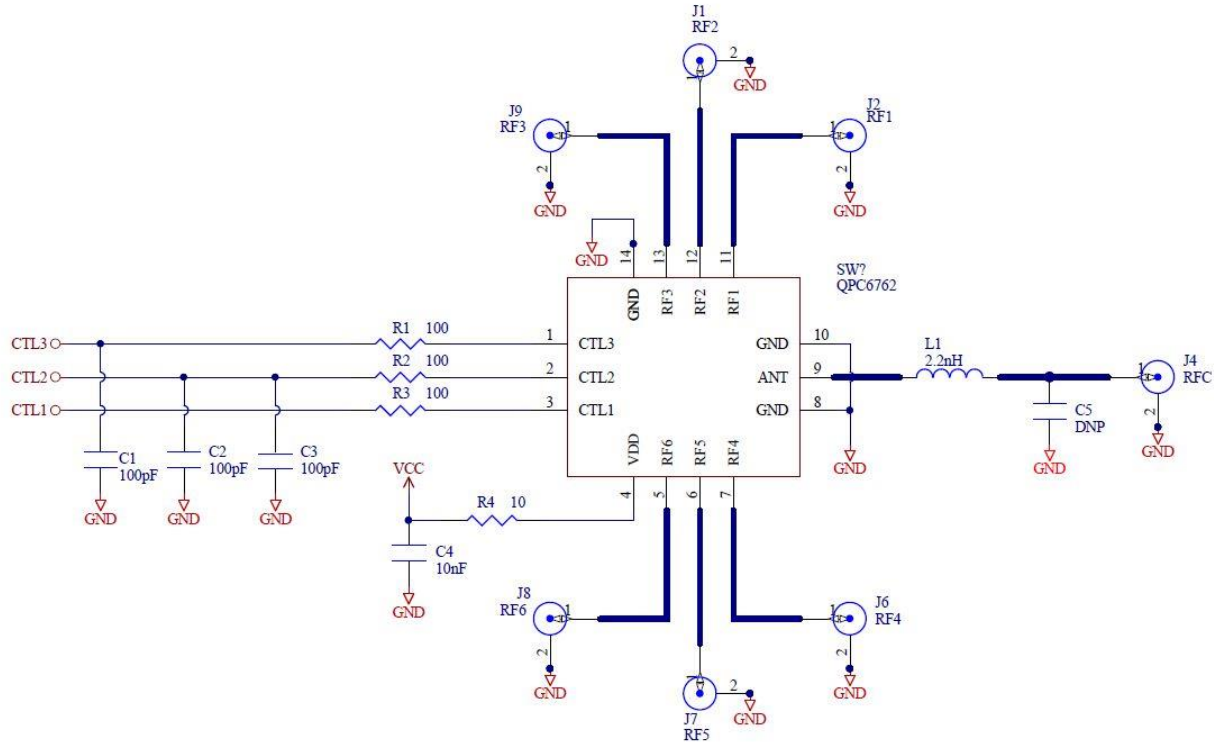

Notes:

1. R1-R4, C1-C4 optional for spurious or RFI suppression.
2. Isolation can be optimized by maximizing ground between RF Ports.
3. L1, C5 optional for improving high frequency return loss.

Package Dimensions

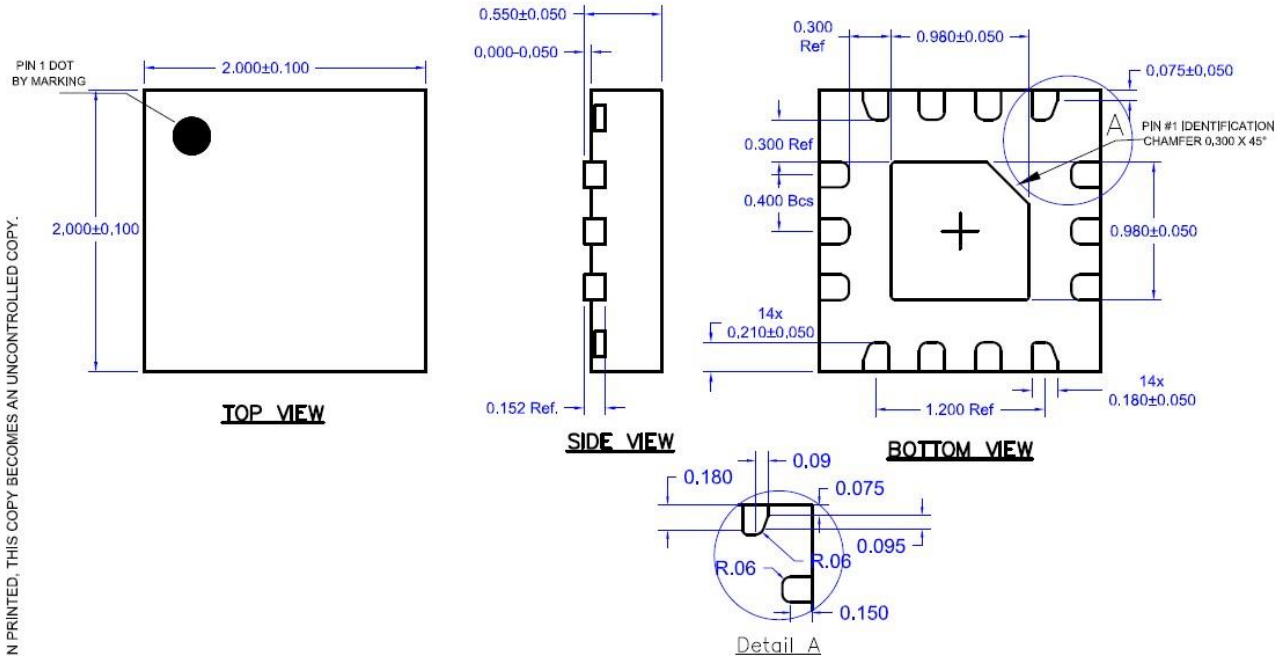

Notes:

1. All dimensions are in millimeters. Angles are in degrees.
2. The terminal #1 identifier and terminal numbering conform to JESD 95-1 SPP-012.
3. Contact plating: NiPdAu

Package Marking

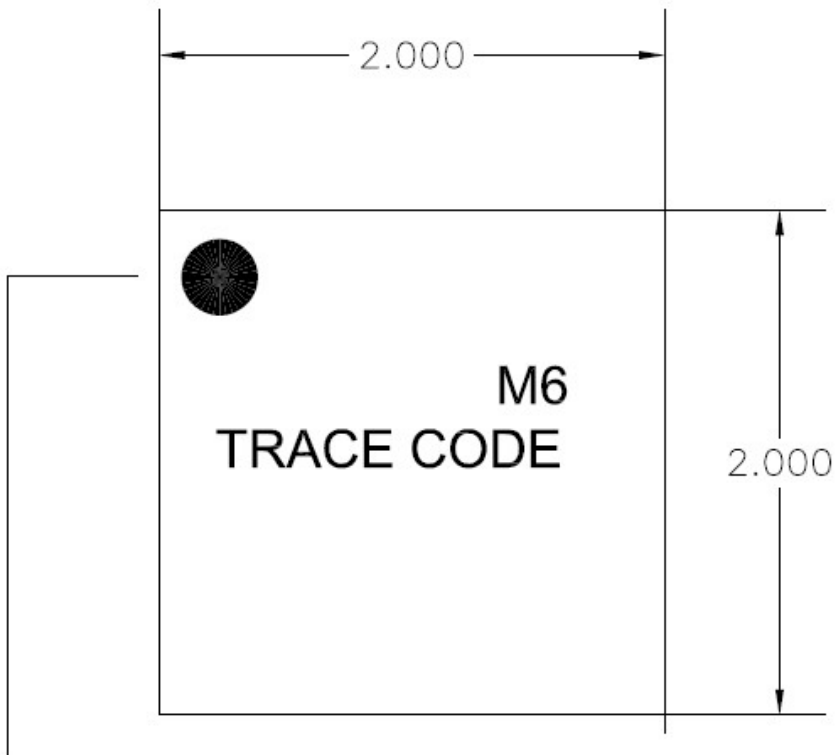

Pin 1 Indicator

Trace Code to be assigned by SubCon

Handling Precautions

| Parameter | Rating | Standard |
|----------------------------------|------------------|----------------------------|
| ESD – Human Body Model (HBM) | Class 2 (2000V) | ANSI/ESD/JEDEC JS-001-2010 |
| ESD – Charged Device Model (CDM) | Class C3 (1000V) | JESD22-C101 |
| MSL – Moisture Sensitivity Level | MSL2 | JEDEC J-STD-020 |



Caution!
ESD-Sensitive Device

Solderability

Compatible with both lead-free (260°C max. reflow temp.) and tin/lead (245°C max. reflow temp.) soldering processes. Solder profiles available upon request.

Contact plating: NiPdAu

RoHS Compliance

This part is compliant with EU 2002/95/EC RoHS directive (Restrictions on the Use of Certain Hazardous Substances in Electrical and Electronic Equipment). This product also has the following attributes:

- Lead Free
- Halogen Free (Chlorine, Bromine)
- Antimony Free
- TBBP-A (C₁₅H₁₂Br₄O₂) Free
- PFOS Free
- SVHC Free
- Qorvo Green



Contact Information

For the latest specifications, additional product information, worldwide sales and distribution locations:

Tel: 1-844-890-8163

Web: www.qorvo.com

Email: customer.support@qorvo.com

Important Notice

The information contained herein is believed to be reliable; however, Qorvo makes no warranties regarding the information contained herein and assumes no responsibility or liability whatsoever for the use of the information contained herein. All information contained herein is subject to change without notice. Customers should obtain and verify the latest relevant information before placing orders for Qorvo products. The information contained herein or any use of such information does not grant, explicitly or implicitly, to any party any patent rights, licenses, or any other intellectual property rights, whether with regard to such information itself or anything described by such information. **THIS INFORMATION DOES NOT CONSTITUTE A WARRANTY WITH RESPECT TO THE PRODUCTS DESCRIBED HEREIN, AND QORVO HEREBY DISCLAIMS ANY AND ALL WARRANTIES WITH RESPECT TO SUCH PRODUCTS WHETHER EXPRESS OR IMPLIED BY LAW, COURSE OF DEALING, COURSE OF PERFORMANCE, USAGE OF TRADE OR OTHERWISE, INCLUDING THE IMPLIED WARRANTIES OF MERCHANTABILITY AND FITNESS FOR A PARTICULAR PURPOSE.**

Without limiting the generality of the foregoing, Qorvo products are not warranted or authorized for use as critical components in medical, life-saving, or life-sustaining applications, or other applications where a failure would reasonably be expected to cause severe personal injury or death.

Copyright 2018 © Qorvo, Inc. | Qorvo is a registered trademark of Qorvo, Inc.