

### Product Overview

The QPL7420 is a GaAs pHEMT single ended RF amplifier IC featuring 20 dB of flat gain and low noise. This IC is designed for applications in the Upstream from 5MHz to 684MHz and in the Downstream from 47MHz to 1800MHz using a single 5V supply, and it can be used from 3V to 8V depending on linearity requirements. QPL7420 offers low noise and distortion plus high gain in a 3 x 3 QFN package for convenient layout and design in set top and infrastructure projects for 75 Ω CATV and satellite applications.

### Functional Block Diagram

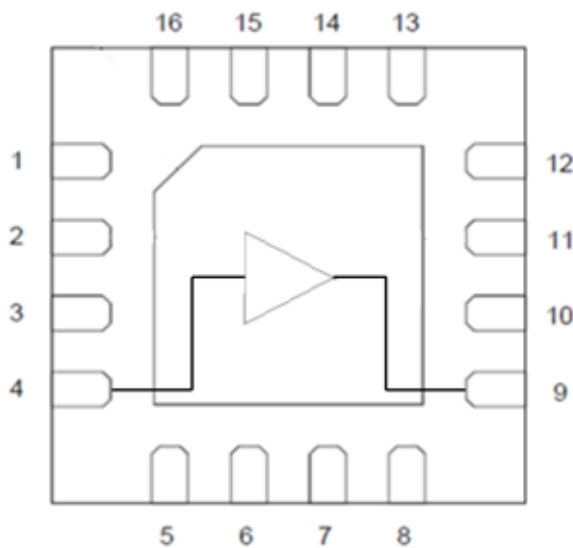

Top View

### Ordering Information

Part Number	Description
QPL7420SB	Sample bag with 5 pieces
QPL7420SR	7" Reel with 100 pieces
QPL7420TR7	7" Reel with 2500 pieces
QPL7420EVB-01	47 – 1800 MHz Evaluation Board
QPL7420EVB-02	5 – 684 MHz Evaluation Board

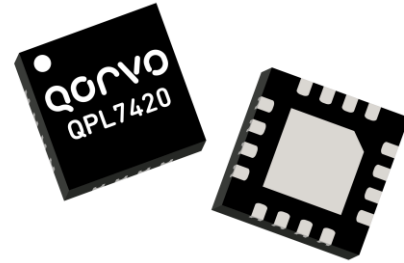

3 x 3 QFN Package

### Key Features

- 5 MHz to 1800 MHz Operation
- 3 V, 5 V, and 8 V Operation
- Gain; 20 dB Typical
- Noise Figure; 1.1 dB Typical at 850 MHz
- Adjustable Bias Using External Resistors
- Convenient QFN Package
- RoHS Compliant

### Applications

- DOCSIS 3.1 and 4.0
- Downstream Applications, 47 to 1800 MHz
- Upstream Applications, 5 to 684 MHz
- Head End CMTS Equipment
- Optical Node
- FTTH GPON and GEPON
- Satellite Low Noise Amplifier
- Cable Modem and Set Top Box
- Single Ended Gain Block

## Absolute Maximum Ratings

Parameter	Rating
Supply Voltage ( $V_{DD}$ )	+10 V
Supply Current ( $I_{DD}$ )	140 mA
Maximum Input Level	65 dBmV
Operating Temperature Range (Bottom of case)	-40 to +100 °C
Storage Temperature Range	-65 to +150 °C
Maximum Junction Temperature	+150 °C

Exceeding any one or a combination of the Absolute Maximum Rating conditions may cause permanent damage to the device. Extended application of Absolute Maximum Rating conditions to the device may reduce device reliability.

## Electrical Specifications, 47 – 1800 MHz (5 V)

Parameter	Condition <sup>(1)</sup>	Min	Typ	Max	Unit
Supply Voltage ( $V_{DD}$ )			5		V
Supply Current ( $I_{DD}$ )			60		mA
Frequency Range		47		1800	MHz
Gain			20.4		dB
Gain Slope	47 -1200 MHz		0.2		dB
	108 – 1800 MHz		0.0		
Reverse Isolation			-23		dB
Input Return Loss			20		dB
Output Return Loss			18		dB
Noise Figure			1.2		dB
OIP2L	47-1200 MHz		47.4		dBm
	108 – 1800 MHz		46.1		
OIP2H	47-1200 MHz		39.4		dBm
	108 – 1800 MHz		39.4		
OIP3	47-1200 MHz		36.3		dBm
	108 – 1800 MHz		35.4		
OP1dB	47-1200 MHz		20.9		dBm
	108 – 1800 MHz		19.3		
Thermal Resistance	$\Theta_{JC}$ (Bottom of Case)		27		°C/W

**Notes:**

1. Typical performance at these conditions: Temp = +25 °C,  $V_{DD}$  = +5 V, 75 ohm system, Full band unless otherwise noted
2. OIP3; +9 dBm/ tone output, 6MHz spacing
3. OIP2; +9 dBm/tone output, 50MHz spacing

**Electrical Specifications, 47 – 1800 MHz (8 V)**

Parameter	Condition <sup>(1)</sup>	Min	Typ	Max	Unit
Supply Voltage (V <sub>DD</sub> )			8		V
Supply Current (I <sub>DD</sub> )			100		mA
Frequency Range		47		1800	MHz
Gain			20.5		dB
Gain Slope	47 -1200 MHz		0.2		dB
	108 – 1800 MHz		0.0		
Reverse Isolation			-23		dB
Input Return Loss			20		dB
Output Return Loss			17.5		dB
Noise Figure			1.2		dB
OIP2L	47-1200 MHz		55.6		dBm
	108 – 1800 MHz		54.0		
OIP2H	47-1200 MHz		44.7		dBm
	108 – 1800 MHz		44.7		
OIP3	47-1200 MHz		41.2		dBm
	108 – 1800 MHz		41.2		
OP1dB	47-1200 MHz		24.5		dBm
	108 – 1800 MHz		23.5		
Thermal Resistance	Θ <sub>JC</sub> (Bottom of Case)		27		°C/W

**Notes:**

1. Typical performance at these conditions: Temp = +25 °C, V<sub>DD</sub> = +8 V, 75 ohm system, Full band unless otherwise noted
2. OIP3; +9 dBm/ tone output, 6MHz spacing
3. OIP2; +9 dBm/tone output, 50MHz spacing

### Evaluation Board Schematic, 47 – 1800 MHz

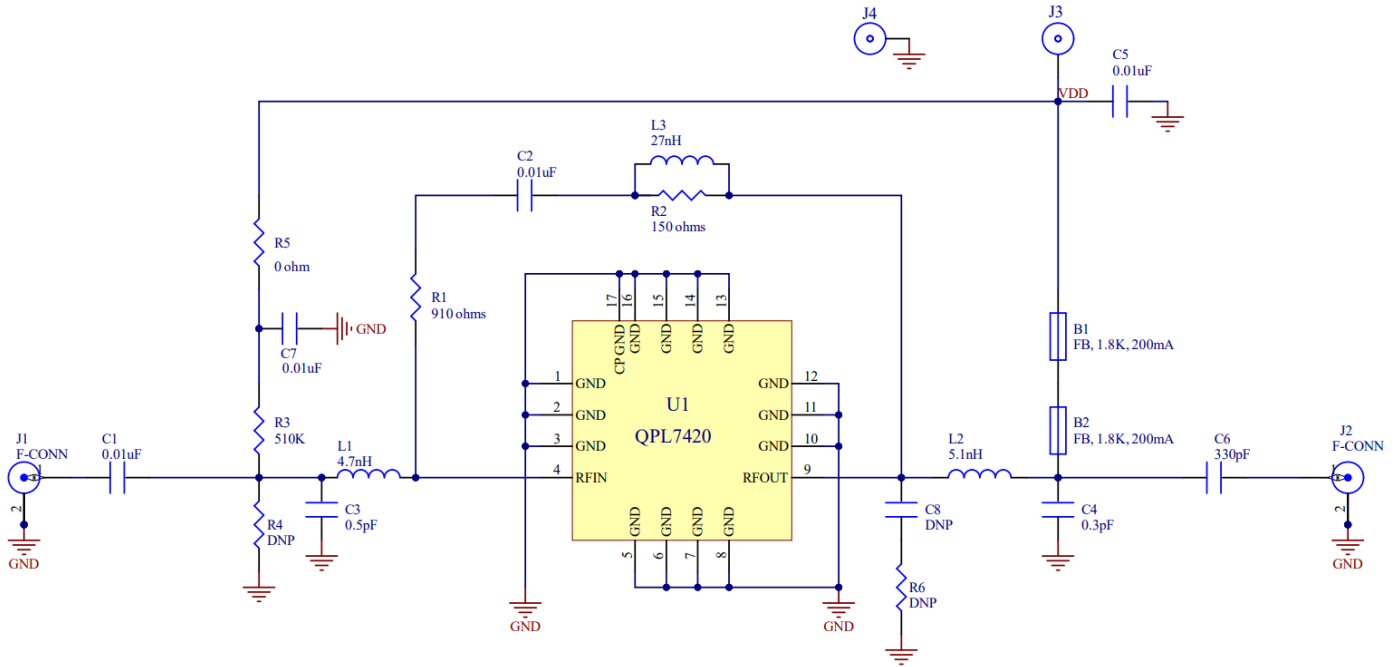

### Evaluation Board Assembly Drawing, 47 – 1800 MHz





### Evaluation Board Bill of Materials, 47 – 1800 MHz

Designator	Description	Manufacturer	Part Number
PCB	QPL7420-4000	TTM	QPL7420-4000(A)
U1	20dB FTTH Amplifier	Qorvo	QPL7420
B1, B2	FER, BEAD, 1.8K, 200mA, 0402	TDK	MMZ1005A182ET000
C1, C2, C5, C7	CAP, 0.01uF, 10%, 50V, X7R, 0402	Murata Electronics	GCM155R71H103KA55D
C3	CAP, 0.5pF, ±0.05pF, 50V, HI-Q, 0402	Murata Electronics	GJM1555C1HR50WB01D
C4	CAP, 0.3pF, +/-0.05pF, 50V, HI-Q, 0402	Murata Electronics	GJM1555C1HR30WB01D
C6	CAP, 330pF, 10%, 50V, X8L, 0402	Murata Electronics	GCM155L81H331KA37D
J1, J2	CONN, F FEM EDGE MOUNT, 75 OHMS, 0.068"	Millimeter Wave Technologies, LLC	MW-846-C-DD-75
J3, J4	TERM. SOLDER TURRET, 0.062 PCB	Mill-Max Manufacturing	2533-0-00-44-00-00-07-0
L1	IND, 4.7nH, +/-0.3nH, M/L, 0402	Murata Electronics	LQG15HN4N7S02D
L2	IND, 5.1nH, +/- 0.3nH, 300mA, M/L, 0402	Murata Electronics	LQG15HS5N1S02D
L3	IND, 27nH, 5%, M/L, 0402	Murata Electronics	LQG15HN27NJ02D
R1	RES, 910 Ω, 5%, 1/16W, 0402	Panasonic Industrial	ERJ-2GEJ911X
R2	RES, 150 OHM, 5%, 1/16W, 0402	Kamaya, Inc	RMC1/16S-151JTH
R3	RES, 510K, 5%, 1/10W, 0402 510K	Kamaya, Inc	RMC 1/16S-514JTH
R5	RES, 0 OHM, 5%, 1/10W, 0402	Kamaya, Inc	RMC1/16SJPTH
C8, R4, R6	Not Populated		

### Typical Application Schematic, 47 – 1800 MHz

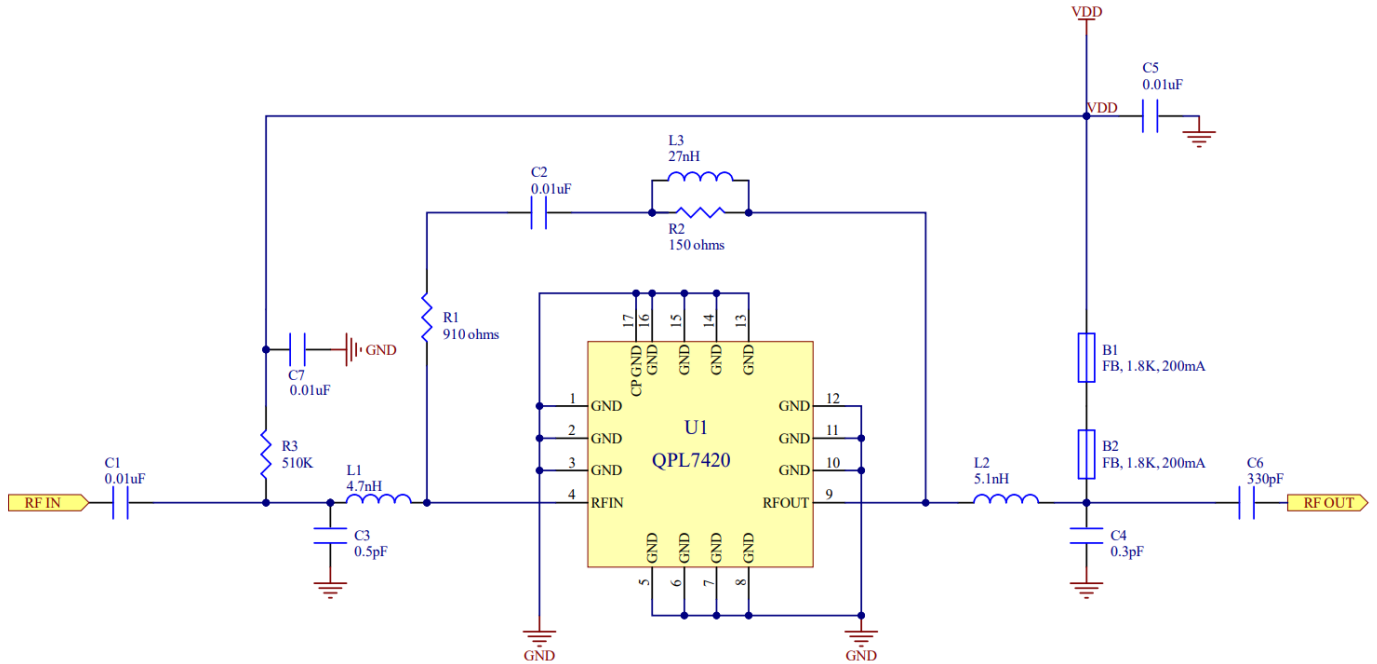

**Notes:**

1. C3/L1 tunes input return loss.
2. L2/C4 tunes output return loss with some contribution from C6.
3. The feedback network is composed of R1 and R2, with C2 being a DC block and L3 providing high end peaking. The ratio of R1 to R2 controls flatness and tilt while the total feedback resistance affects device gain.
4. B1, B2 provides the bias path with RF isolation from the RF output path.
5. R3 is adjusted to increase linearity or reduce power to set the desired operating point (Refer to Table 1 below).

Table 1, Pullup Resistor Options

Bias Current vs R3/R4			
R3 Pullup (ohms)	R4 Pulldown (ohms)	VDD (V)	IDD (mA)
DNP	DNP	8	80.0
620K	DNP	8	100.0
240K	DNP	8	120.0
180K	DNP	8	140.0
DNP	DNP	5	50.0
180K	DNP	5	80.0
76.8K	DNP	5	120.0
56K	DNP	5	140.0

### Performance Data, 47 – 1800 MHz (5 V)

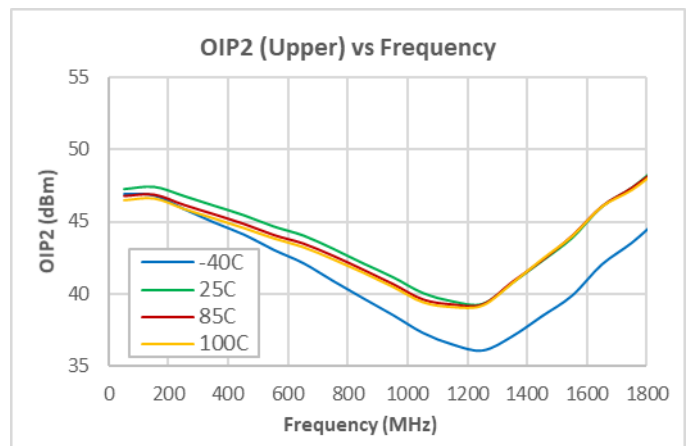
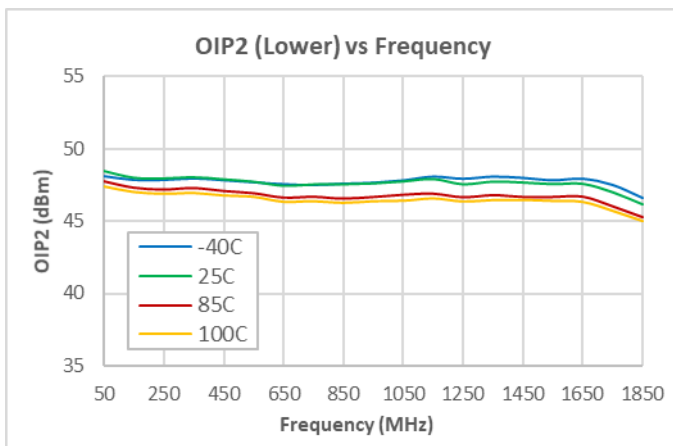
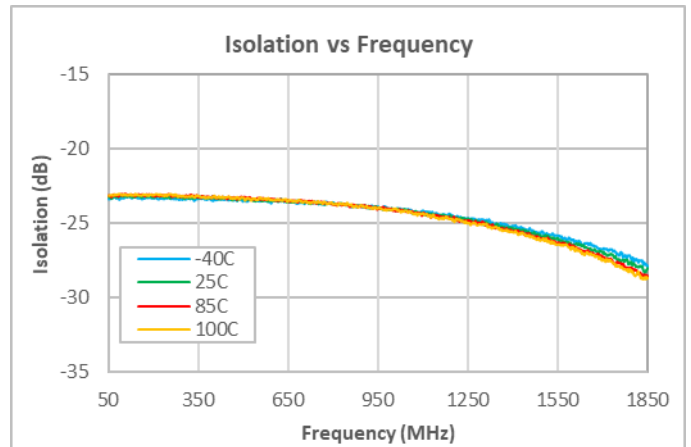
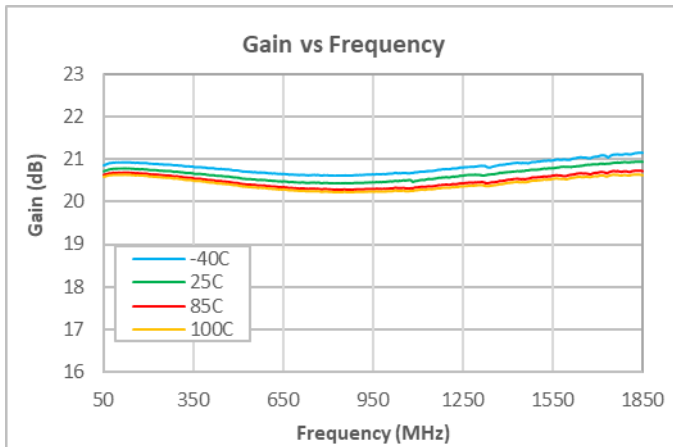
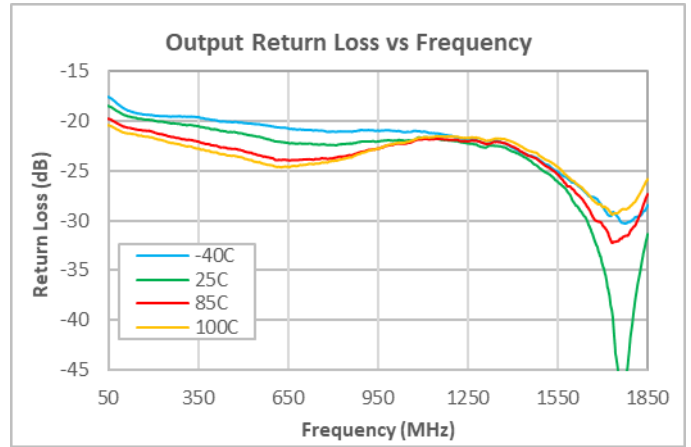
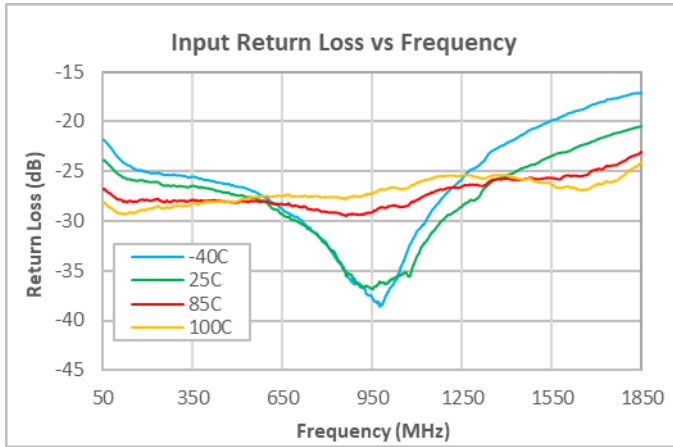

- Notes:
- (1) Temperature 25 °C, 75 ohm test system, nominal current (unless otherwise noted).
  - (2) OIP2: 9 dBm/tone output, 50 MHz spacing.

**Performance Data, 47 – 1800 MHz (5 V)**

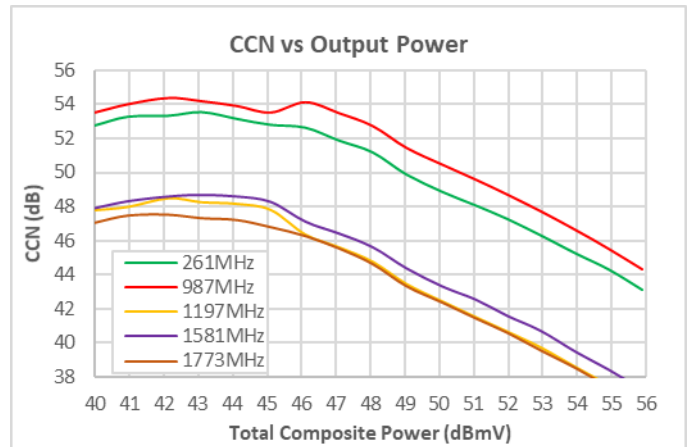
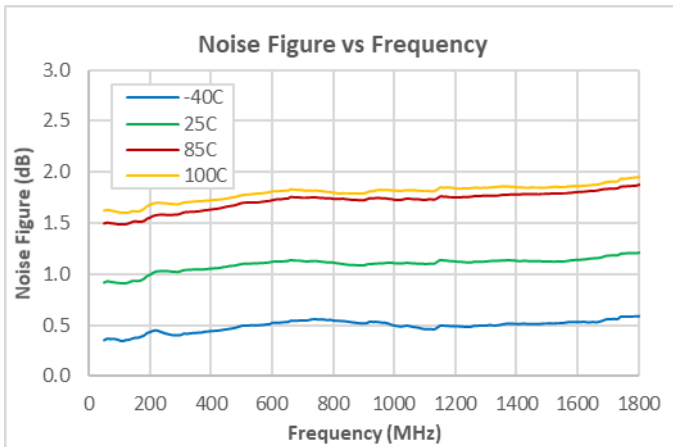
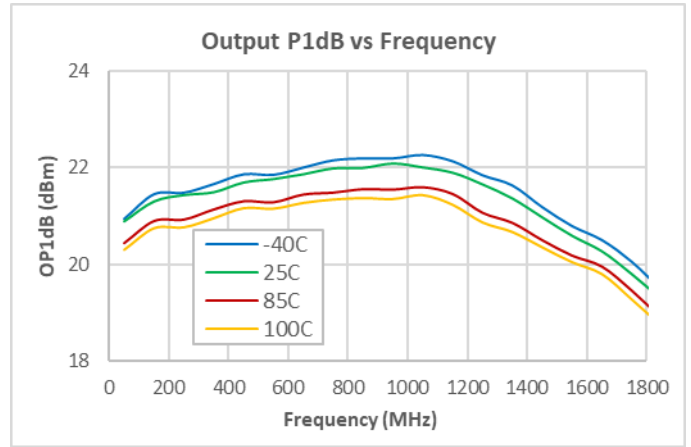
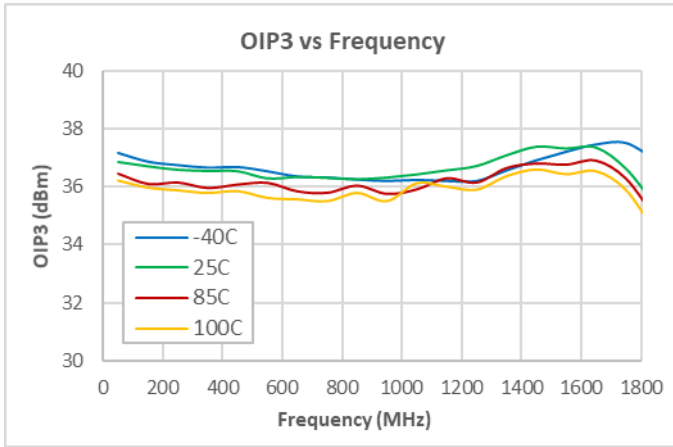

**Notes:**

- (1) Temperature 25 °C, 75 ohm test system, nominal current (unless otherwise noted).
- (2) OIP3: 9 dBm / tone output, 6 MHz spacing.
- (3) CCN: 261 – 1791 MHz SC QAM, 0 dB Tilt, 6 dB Stepdown at 1020 MHz.



**Performance Data, 47 – 1800 MHz (8 V)**

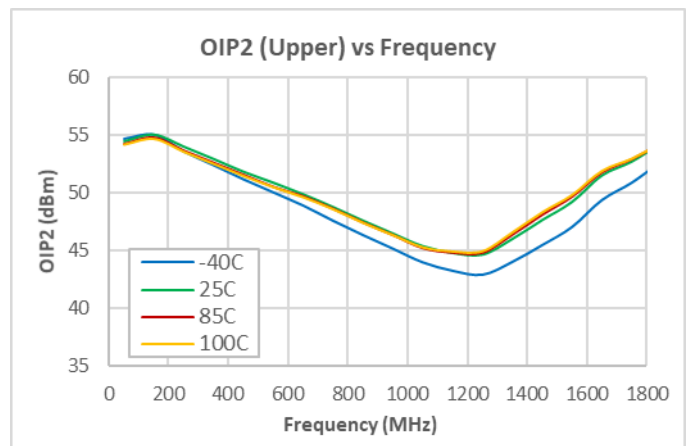
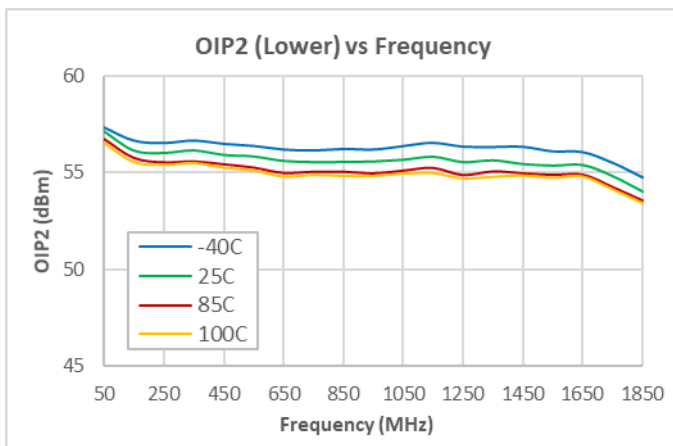
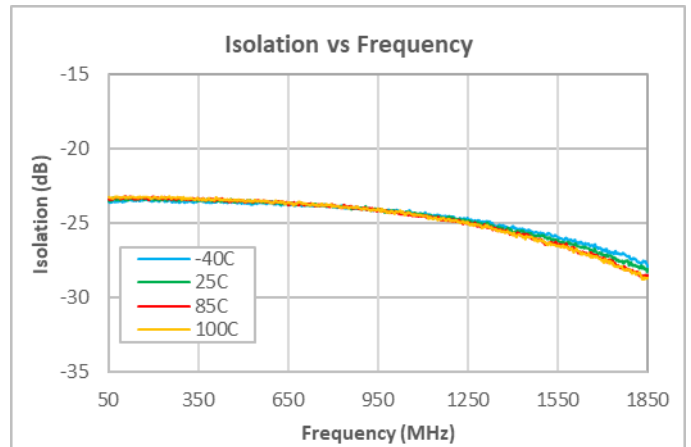
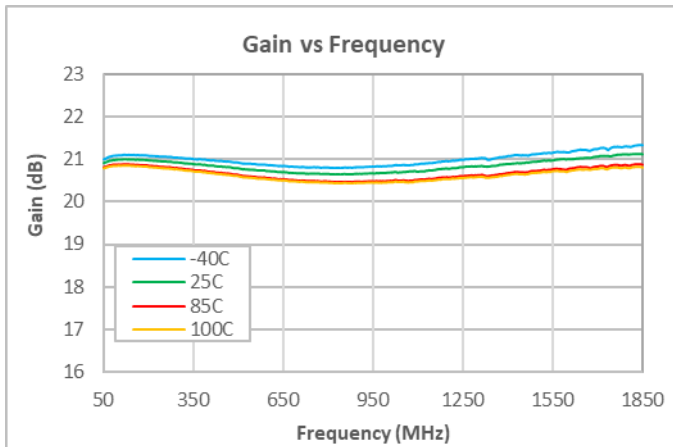
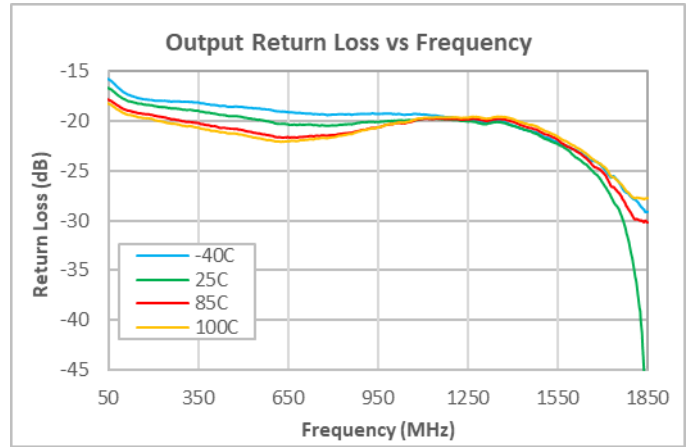
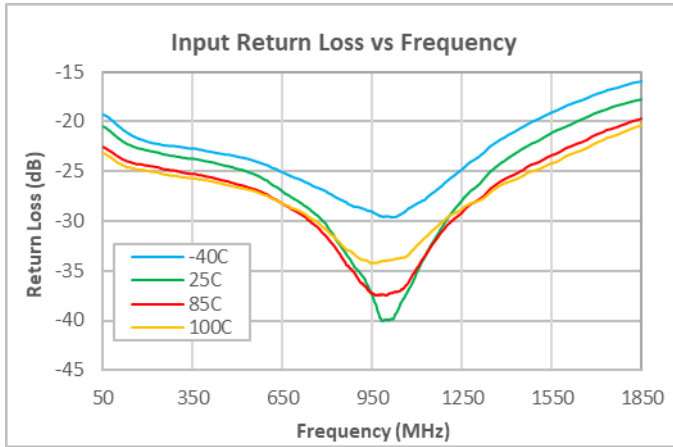

- Notes:
- (1) Temperature 25 °C, 75 ohm test system, nominal current (unless otherwise noted).
  - (2) OIP2: 9 dBm/tone output, 50 MHz spacing.

**Performance Data, 47 – 1800 MHz (8 V)**

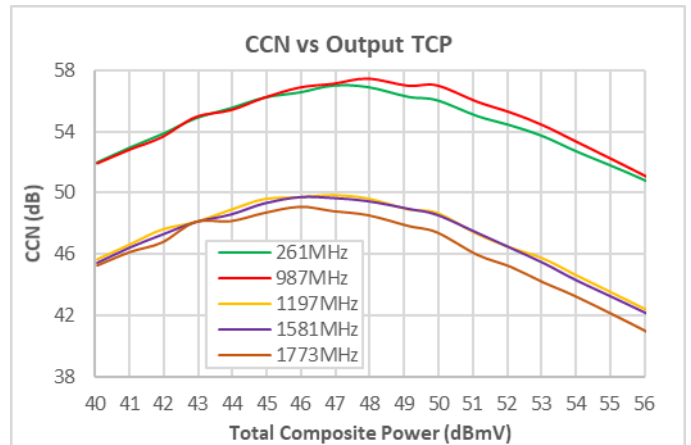
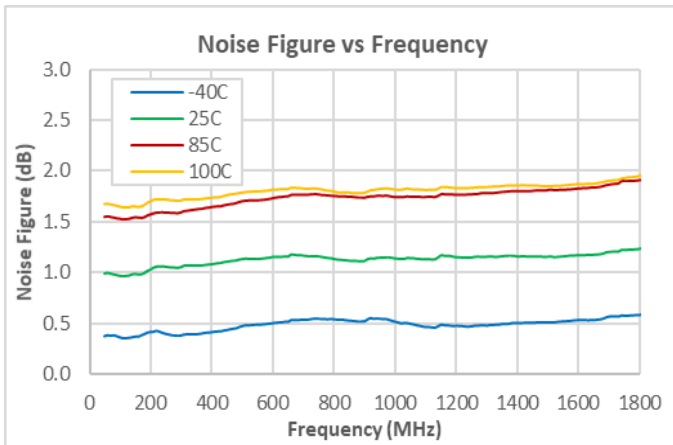
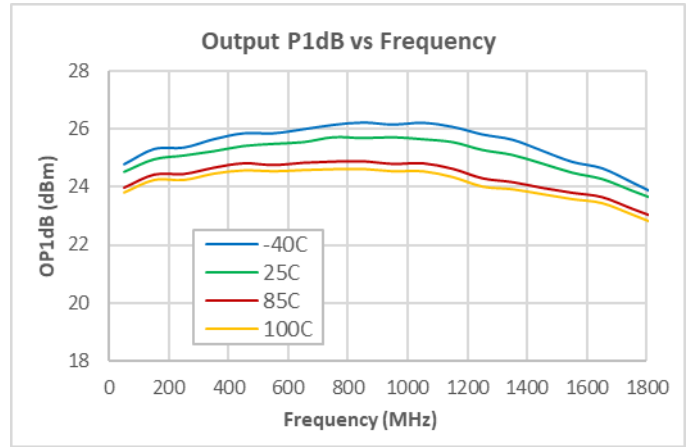
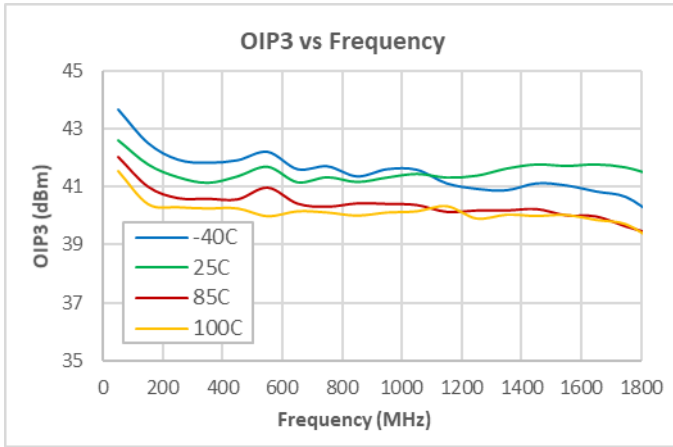

**Notes:**

- (1) Temperature 25 °C, 75 ohm test system, nominal current (unless otherwise noted).
- (2) OIP3: 9 dBm / tone output, 6 MHz spacing.
- (3) CCN: 261 – 1791 MHz SC QAM, 0 dB Tilt, 6 dB Stepdown at 1020 MHz.

**Performance Data vs Supply Voltage, 47 – 1800 MHz**

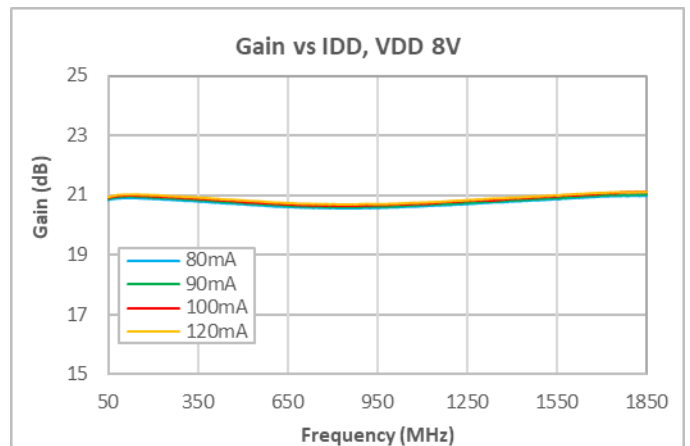
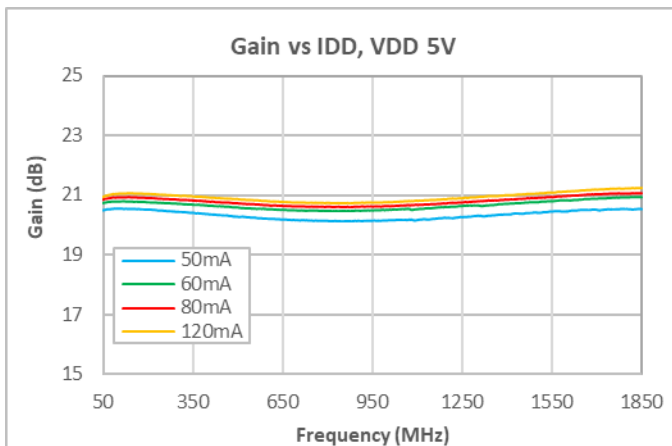
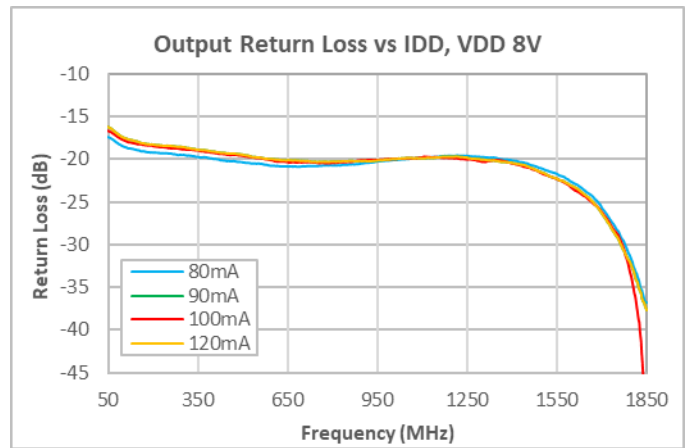
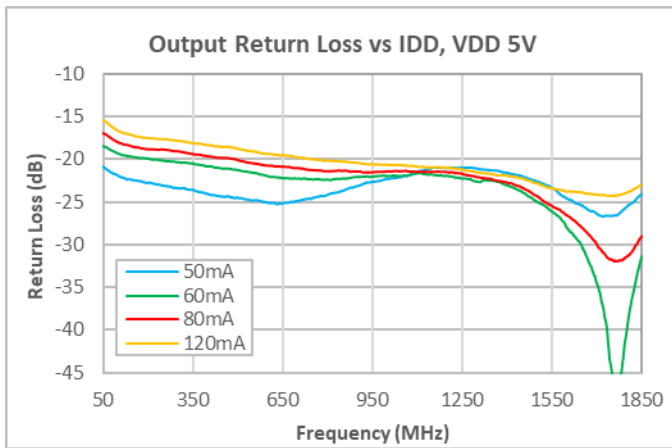
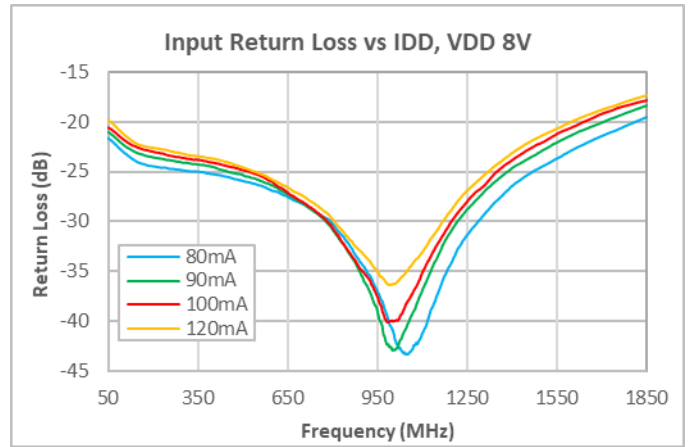
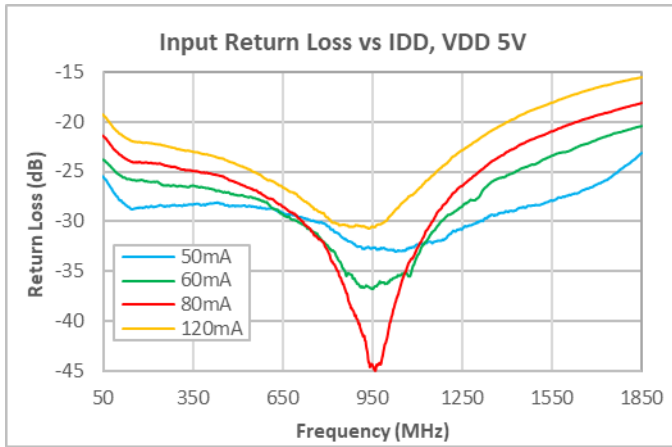

**Notes:**

- (1) Temperature 25 °C, 75 ohm test system, nominal current (unless otherwise noted).

### Performance Data vs Supply Voltage, 47 – 1800 MHz

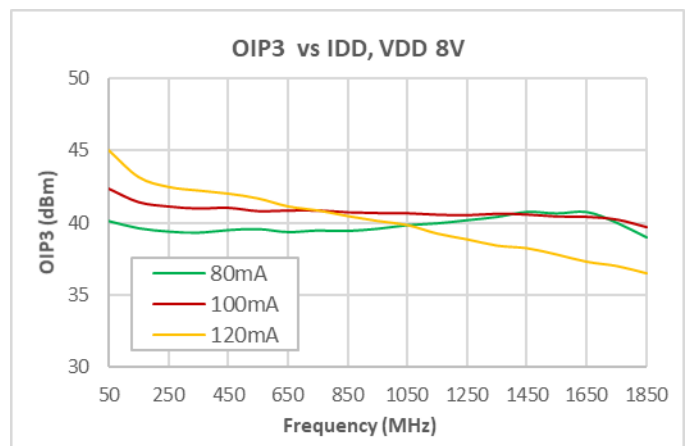
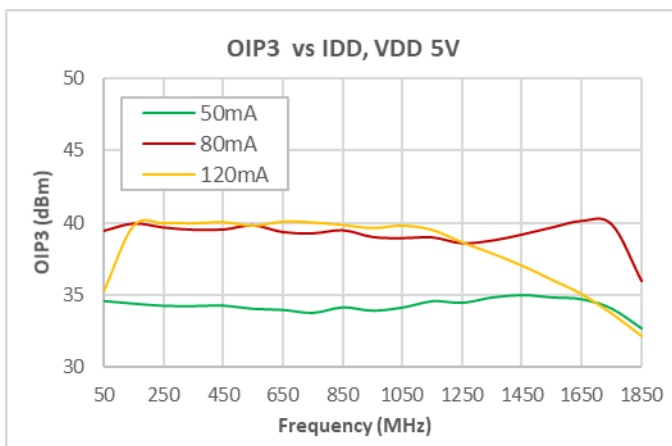
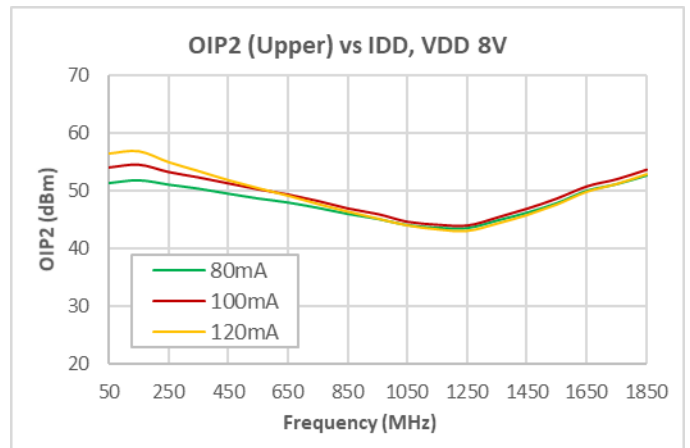
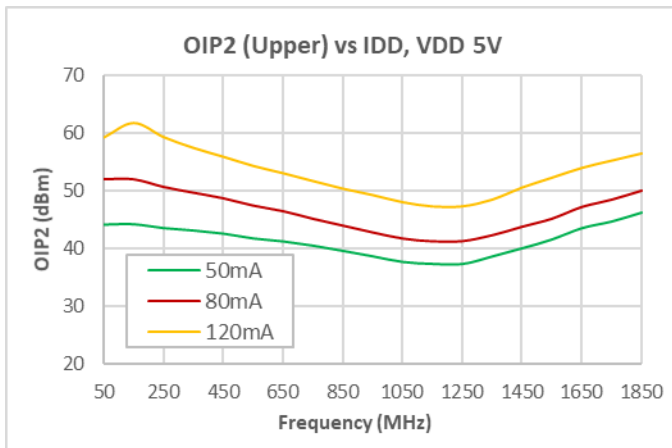
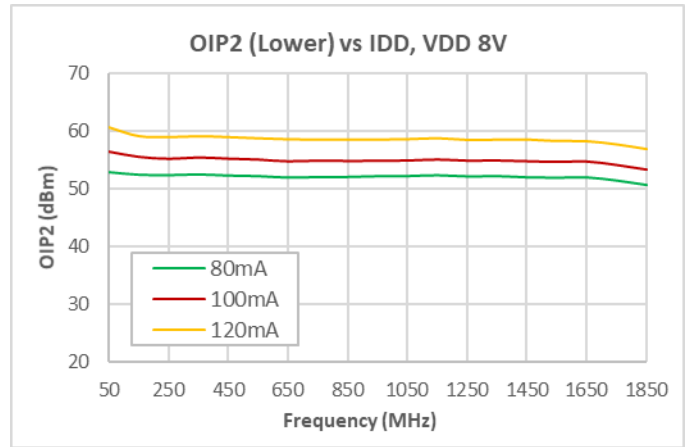
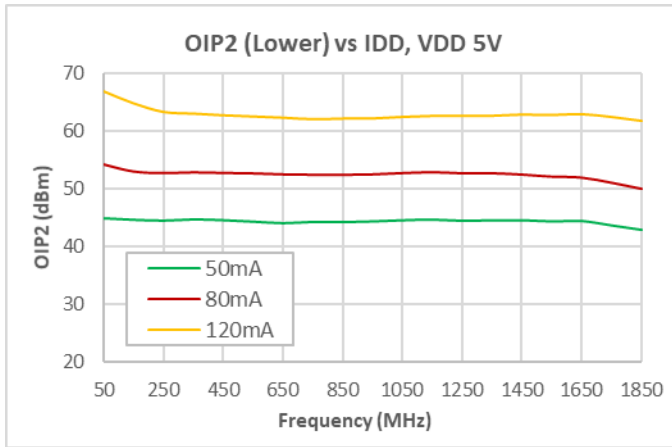

**Notes:**

- (1) Temperature 25 °C, 75 ohm test system, nominal current (unless otherwise noted).
- (2) OIP2; 9 dBm/tone, 50 MHz spacing.
- (3) OIP3; 9 dBm/tone, 6 MHz spacing.

**Performance Data vs Supply Voltage, 47 – 1800 MHz**

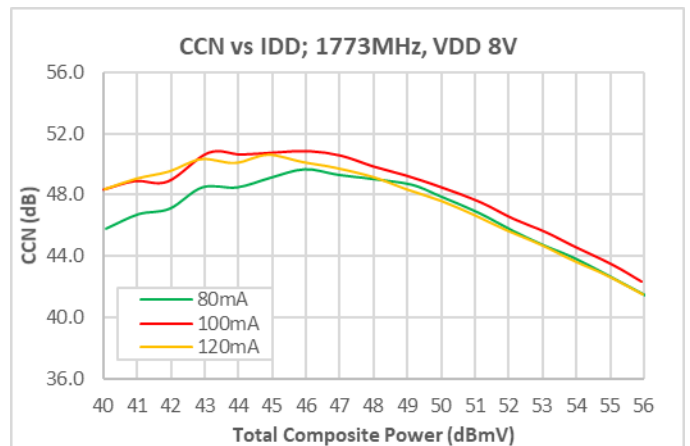
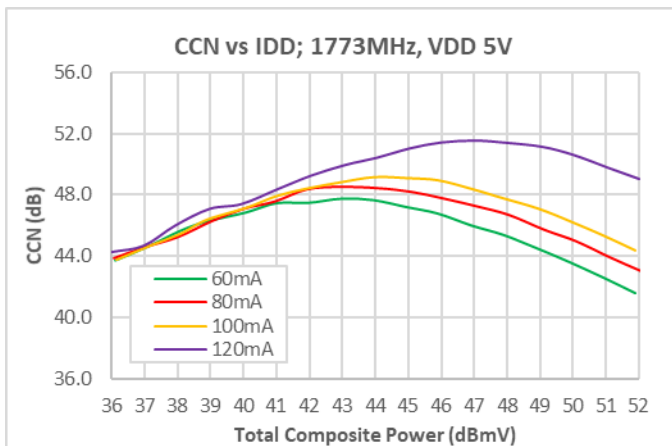
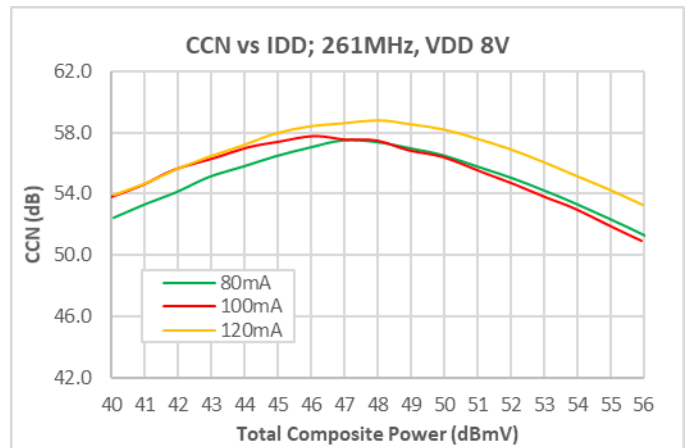
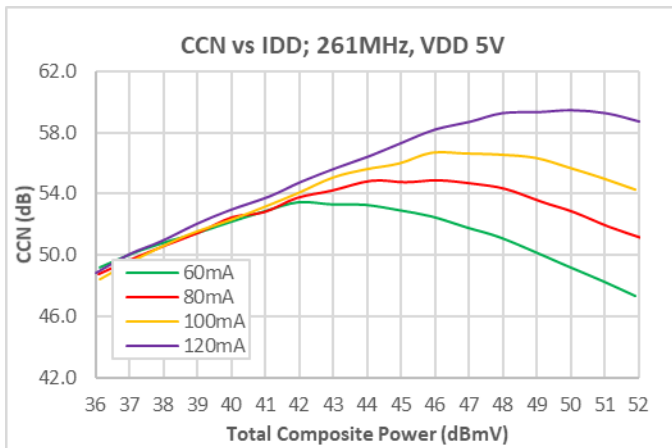
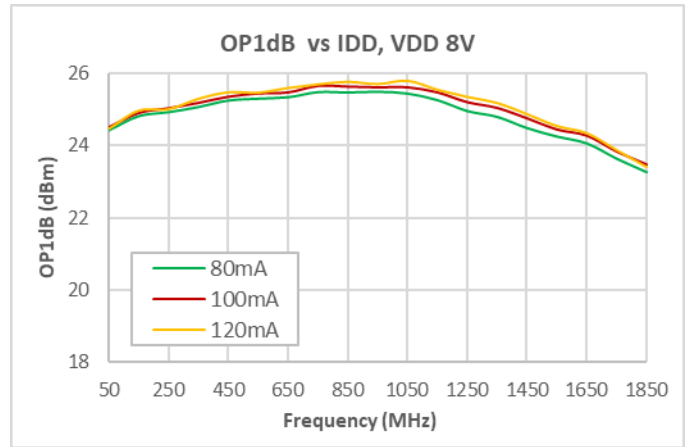
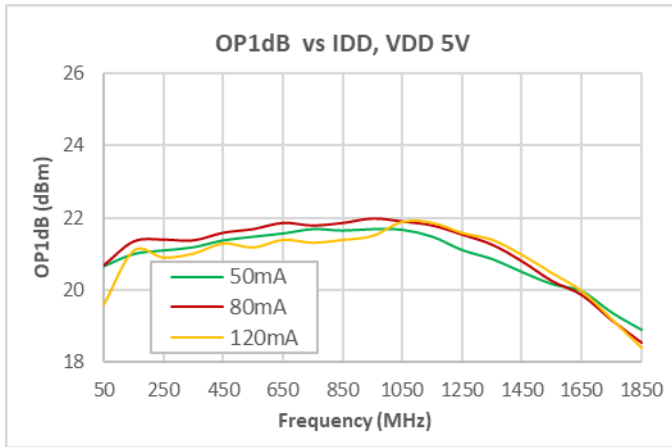

- Notes:
- (1) Temperature 25 °C, 75 ohm test system, nominal current (unless otherwise noted).
  - (2) CCN: 261 – 1791 MHz SC QAM, 0 dB Tilt, 6 dB Stepdown at 1020 MHz.

### Performance Data vs Supply Voltage, 47 – 1800 MHz

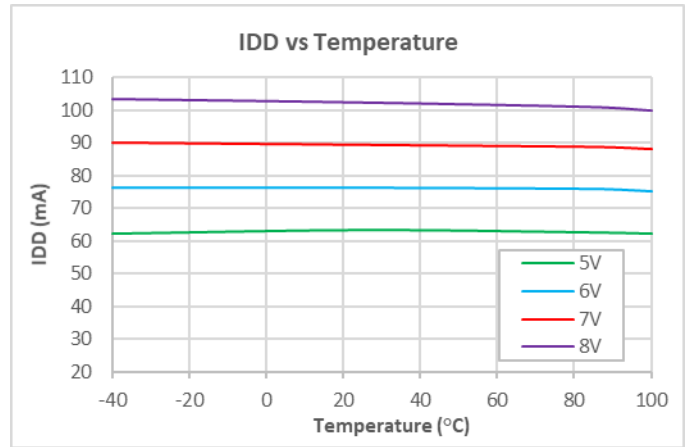
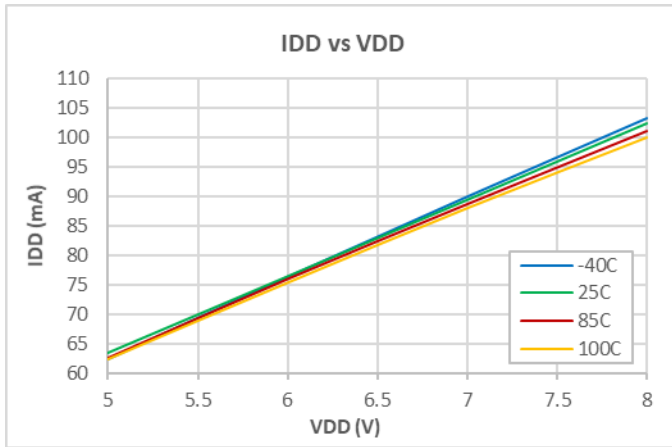

Notes:

- (1) Temperature 25 °C, 75 ohm test system, nominal current (unless otherwise noted).

**Electrical Specifications, 5 – 700 MHz (5 V)**

Parameter	Condition <sup>(1)</sup>	Min	Typ	Max	Unit
Supply Voltage (V <sub>DD</sub> )			5		V
Supply Current (I <sub>DD</sub> )			50		mA
Frequency Range		5		700	MHz
Gain			20.3		dB
Gain Slope			0.1		dB
Reverse Isolation			-23		dB
Input Return Loss			19		dB
Output Return Loss			18.5		dB
Noise Figure			1.3		dB
MER	At 53.5dBmV TCP, 5 - 204 MHz, 0dB tilt, 33ch 256QAM ITU-T J.83, Annex B		42		dB
OIP2L			41.5		dBm
OIP2H			42.7		dBm
OIP3			33.0		dBm
OP1dB	204 MHz		21.5		dBm
Thermal Resistance	Θ <sub>JC</sub> , Bottom of Case		27		°C/W

**Notes:**

1. Typical performance at these conditions: Temp = +25 °C, V<sub>DD</sub> = +5V, 75 ohm system, Full band unless otherwise noted
2. OIP3; +9 dBm/ tone output, 6 MHz spacing
3. OIP2; +9 dBm/tone output, 6 MHz spacing

**Electrical Specifications, 5 – 700 MHz (8 V)**

Parameter	Condition <sup>(1)</sup>	Min	Typ	Max	Unit
Supply Voltage (V <sub>DD</sub> )			8		V
Supply Current (I <sub>DD</sub> )			80		mA
Frequency Range		5		700	MHz
Gain			20.7		dB
Gain Slope			0.0		dB
Reverse Isolation			19.5		dB
Input Return Loss			22		dB
Output Return Loss			18		dB
Noise Figure			1.3		dB
MER	At 57.5dBmV TCP, 5 - 204 MHz, 0dB tilt, 33ch 256QAM ITU-T J.83, Annex B		45dB		dB
OIP2L			50.8		dBm
OIP2H			48.6		dBm
OIP3			39.3		dBm
OP1dB	204 MHz		25.5		dBm
Thermal Resistance	Θ <sub>JC</sub> , Bottom of Case		27		°C/W

**Notes:**

1. Typical performance at these conditions: Temp = +25 °C, V<sub>DD</sub> = +5V, 75 ohm system, Full band unless otherwise noted
2. OIP3; +9 dBm/ tone output, 6 MHz spacing
3. OIP2; +9 dBm/tone output, 6 MHz spacing



### Evaluation Board Schematic, 5 – 700 MHz

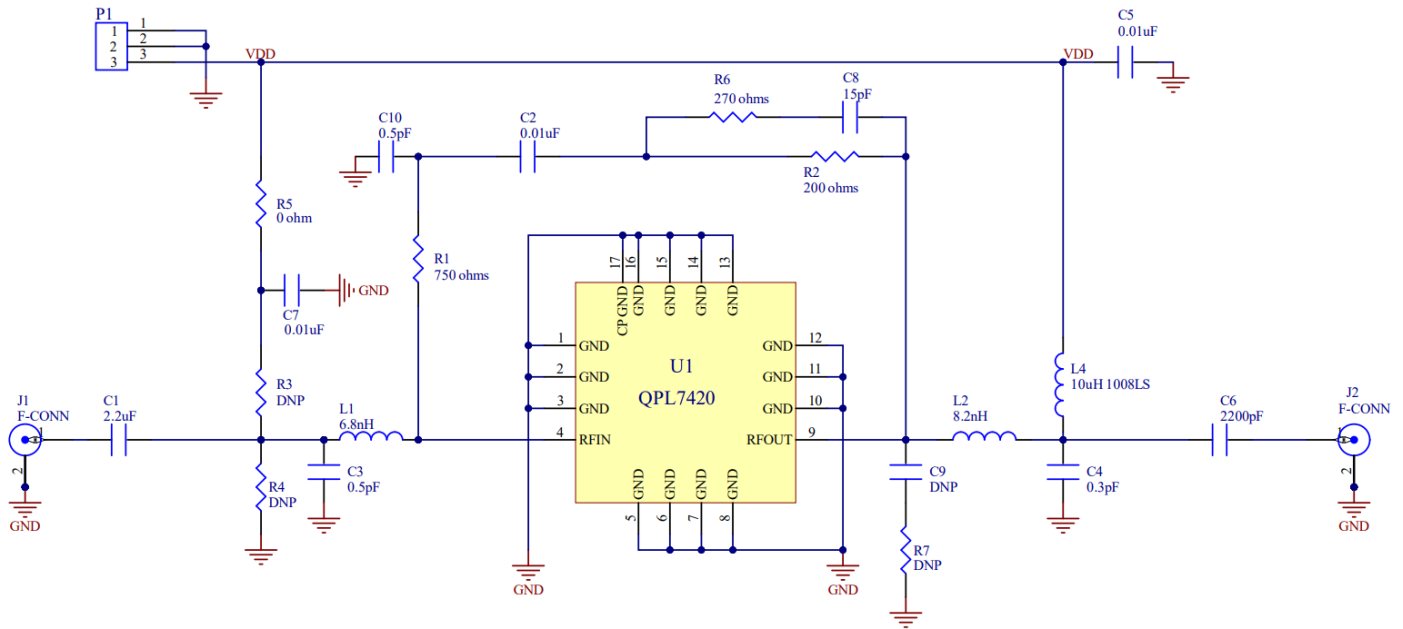

Notes:

1. C3/L1 tunes input return loss.
2. L2/C4 tunes output return loss with some contribution from C6.
3. C9/R7 can also be used for output return loss tuning if needed for bandwidth limiting and stability enhancement.
4. R1, R2, and the blocking cap, C2 are the basic feedback loop for setting gain.
5. C8 and R6 in parallel with R2 help improve gain flatness at low frequency.
6. C10 improves gain slope when C8 and R6 are present.
7. L4 provides the bias path with RF isolation from the RF output path. A variety of RF chokes may be used as long as sufficient inductance is provided to ensure good performance at 5MHz with bias without causing unwanted behavior out of band.
8. R3 and R4 are used to change the bias current for desired linearity and NPR dynamic range (Refer to Table 1).

### Evaluation Board Assembly Drawing, 5 – 700 MHz

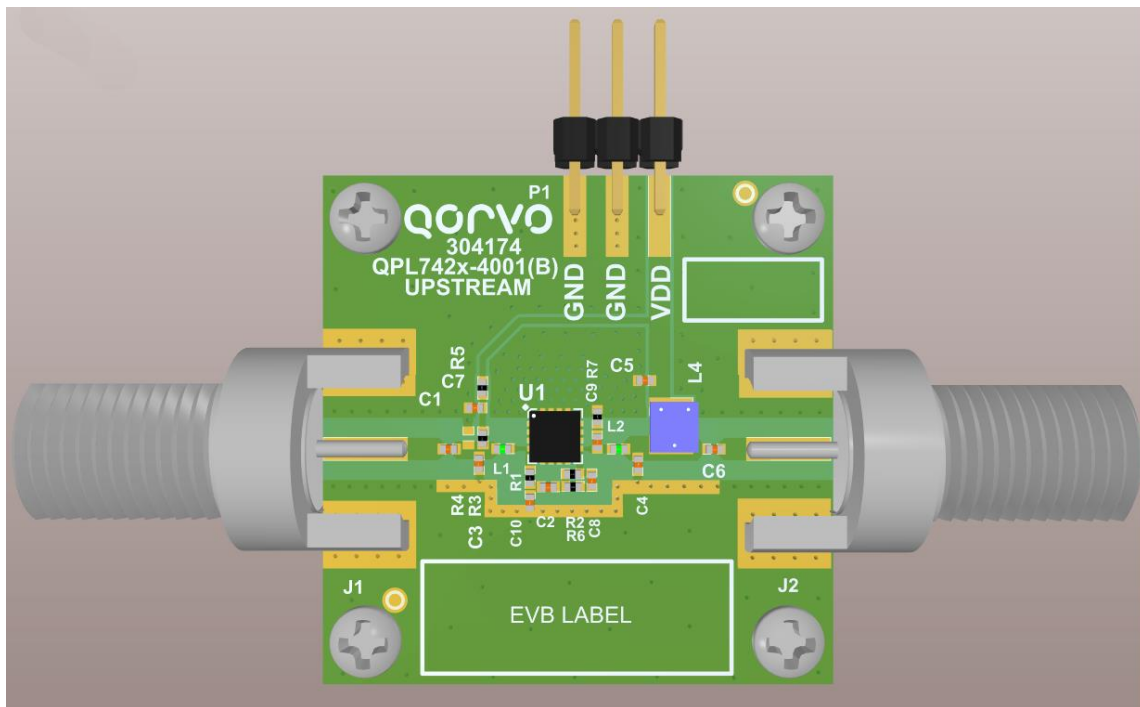

### Evaluation Board Bill of Materials, 5 – 700 MHz

Designator	Description	Manufacturer	Part Number
PCB	QPL7420-4001	TTM	QPL7420-4001(B)
U1	20dB FTTH Amplifier	Qorvo	QPL7420
C1	CAP, 2.2uF, 10%, 16V, X5R, 0402	Murata	GRM155R61C225KE11D
C2, C5, C7	CAP, 0.01uF, 10%, 50V, X7R, 0402	Murata	GCM155R71H103KA55D
C3, C10	CAP, 0.5pF, ±0.05pF, 50V, HI-Q, 0402	Murata	GJM1555C1HR50WB01D
C4	CAP, 0.3pF, +/-0.05pF, 50V, HI-Q, 0402	Murata	GJM1555C1HR30WB01D
C6	CAP, 2200pF, 5%, 50V, X7R, 0402	Murata	GRM155R71H222JA01D
C8	CAP, 15pF, 2%, 50V, HI-Q, 0402	Murata	GJM1555C1H150GB01D
L1	IND, 6.8nH, 2%, 600mA, M/L, 0402	Murata	LQG15HS6N8G02D
L2	IND, 8.2nH, 2%, 550mA, M/L, 0402	Murata	LQG15HS8N2G02D
L4	IND, 10uH, 10%, W/W, 1008	Coilcraft	1008LS-103XJLC
R1	RES, 750 OHM, 1%, 1/16W, 0402	Yageo	RC0402FR-07750RL
R2	RES, 200 OHM, 5%, 1/16W, 0402	Kamaya	RMC1/16S-201JTH
R5	RES, 0 OHM, 5%, 1/10W, 0402	Kamaya	RMC1/16SJPTH
R6	RES, 270 OHM, 1%, 1/16W, 0402	Yageo	RC0402FR-07270RL
J1, J2	CONN, F FEM EDGE MOUNT, 75 OHMS, 0.068"	Millimeter Wave Technologies	MW-846-C-DD-75
P1	CONN, HDR, ST, 1x3, 0.100", HI-TEMP, T/H	Samtec Inc.	HTSW-103-07-G-S
Heat Sink	HEATSINK BLOCK, 1.16 SQ I	Robert S. Wells	EEF-102059
Screws	SCREW, 2-56X3/16", SOCKET HD	McMaster-Carr Supply Co.	92196A076
C9, R3, R4, R7	Not Populated Item		

**Performance Data, 5 – 700 MHz (5 V)**

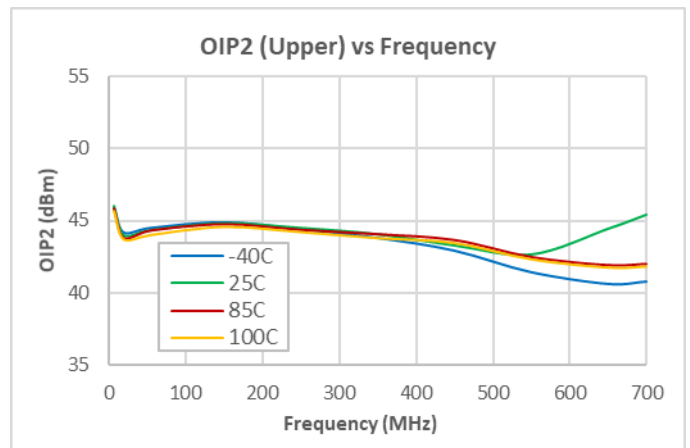
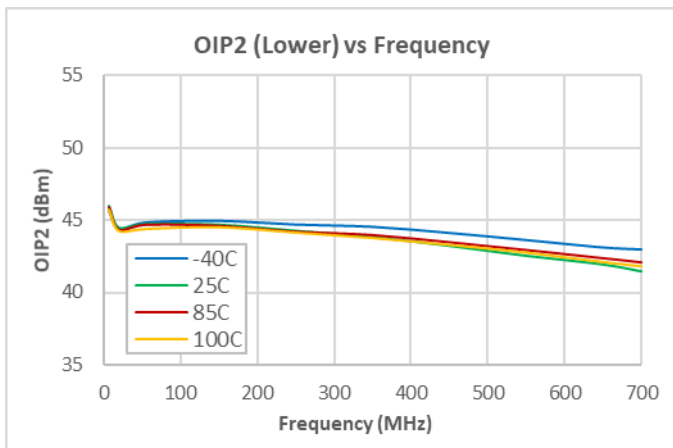
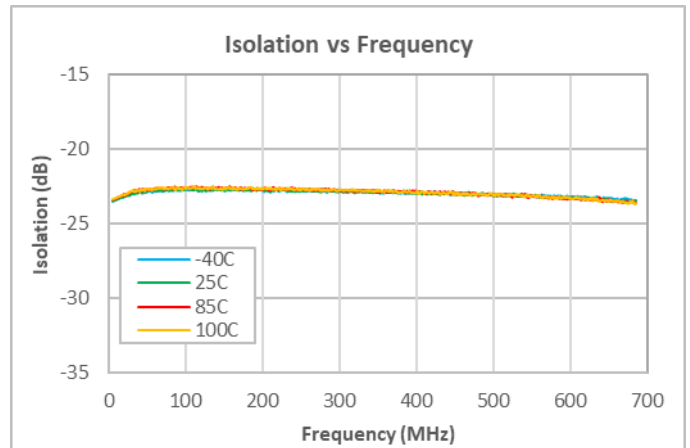
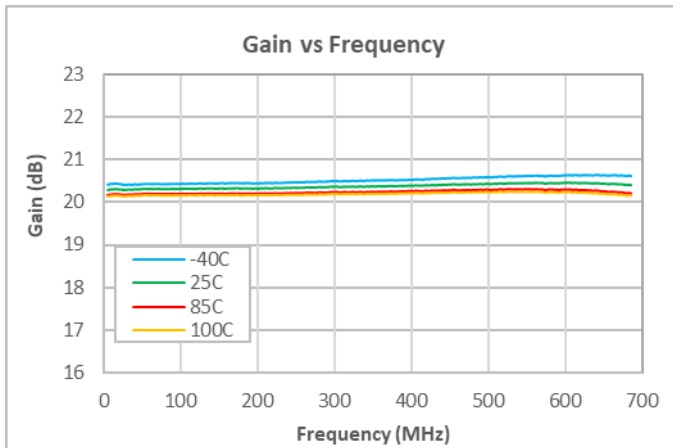
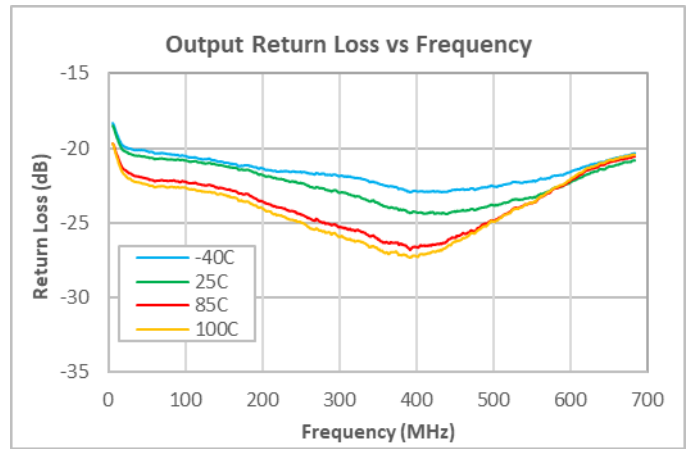
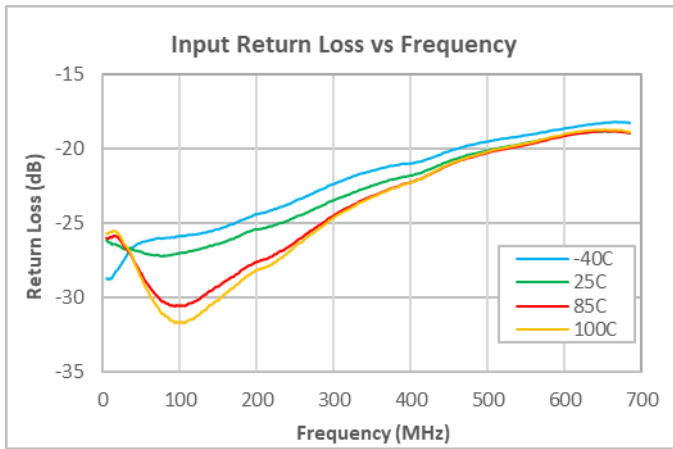

- Notes:
- (1) Temperature 25 °C, 75 ohm test system, nominal current (unless otherwise noted).
  - (2) OIP2; +9 dBm/tone output, 6 MHz spacing

**Performance Data, 5 – 700 MHz (5 V)**

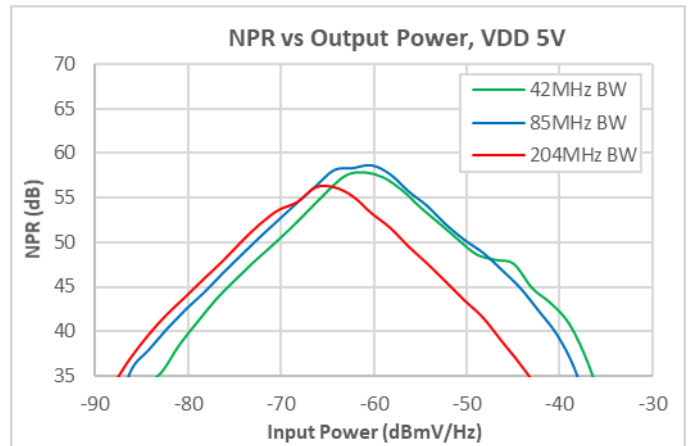
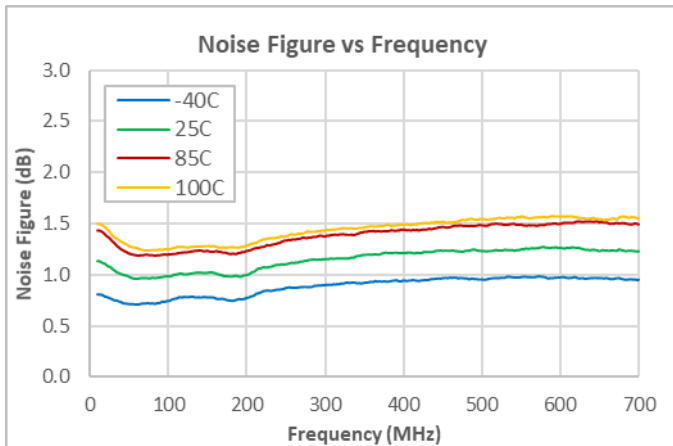
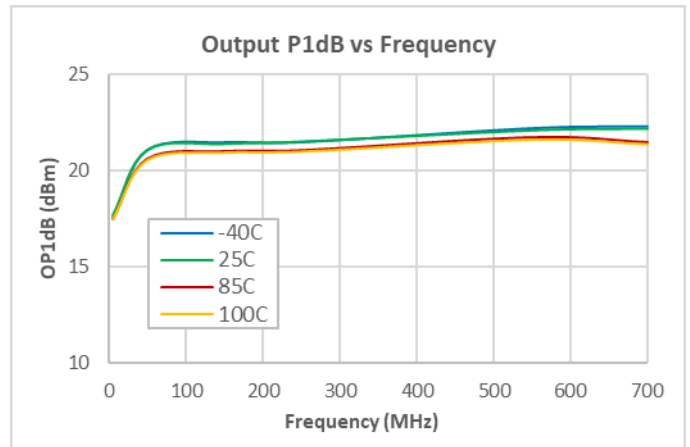
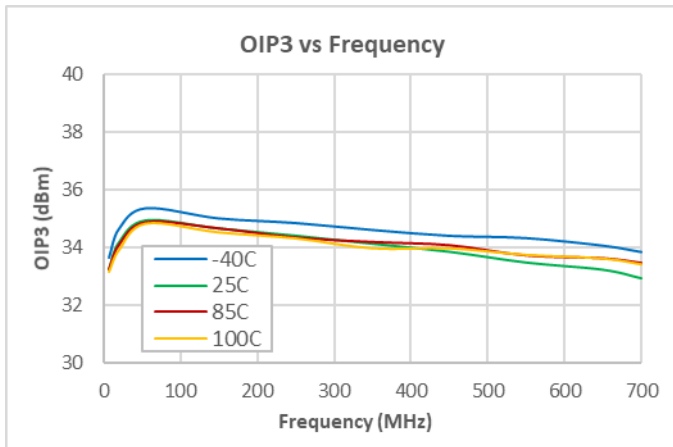

**Notes:**

- (1) Temperature 25 °C, 75 ohm test system, nominal current (unless otherwise noted).
- (2) OIP3; +9 dBm/tone output, 6 MHz spacing

**Performance Data, 5 – 700 MHz (5 V)**

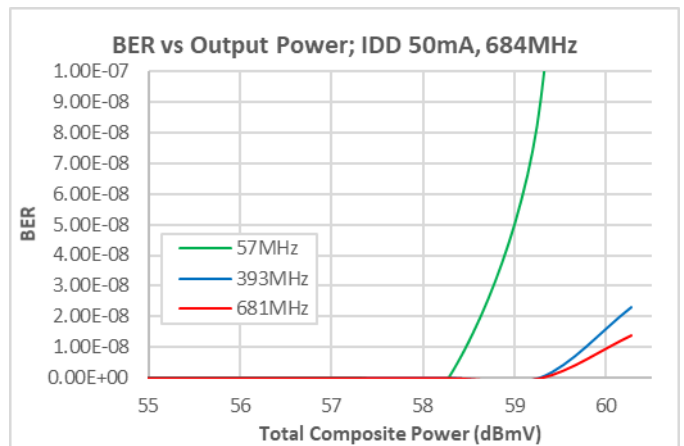
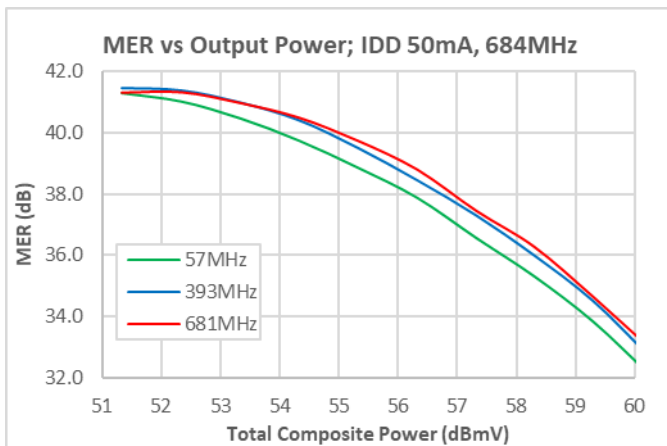
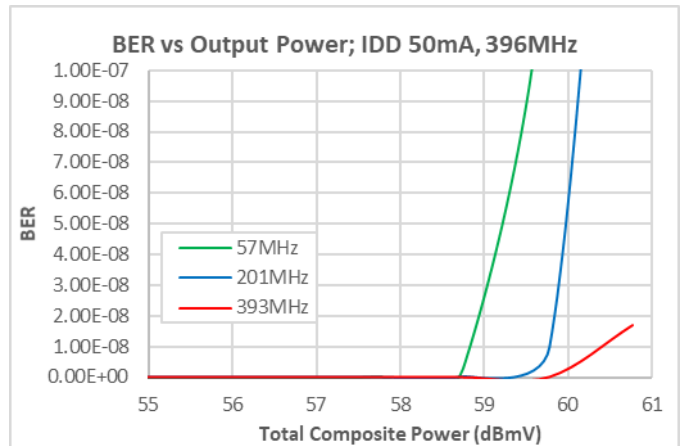
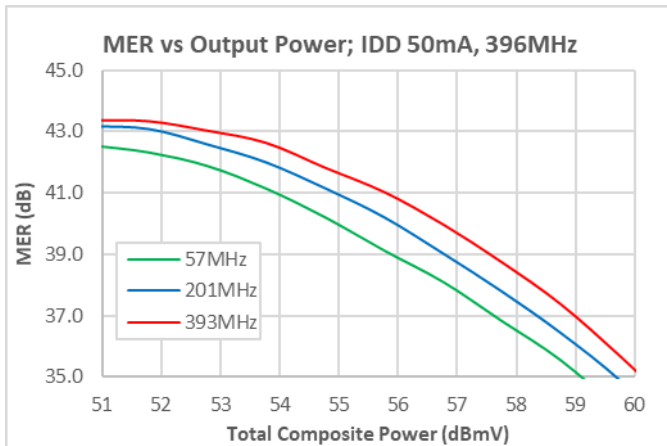
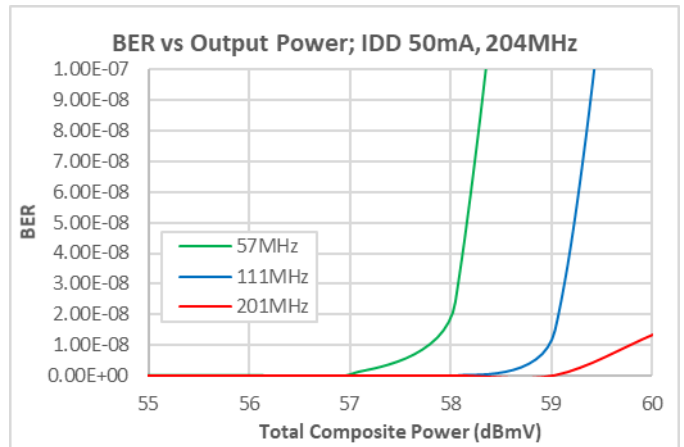
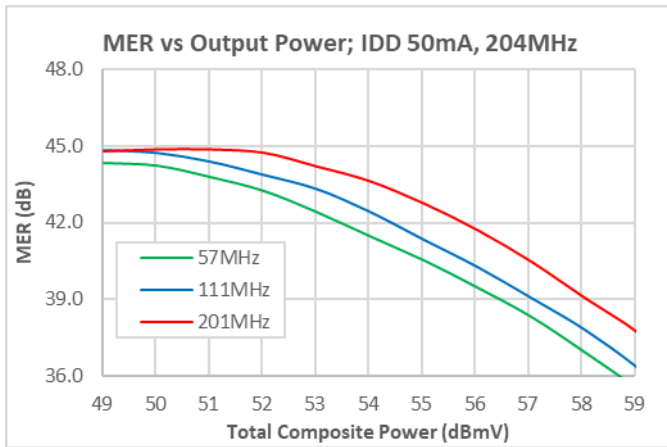

- Notes:
- (1) Temperature 25 °C, 75 ohm test system, nominal current (unless otherwise noted).
  - (2) MER/BER; 256 QAM, 0dB Tilt, ITU-T J.83, Annex B, Source Corrected, Maximum Correction 4.3 dB
    - a. 204 MHz; 33Ch. 5 – 204 MHz
    - b. 396 MHz; 65Ch. 5 – 396 MHz
    - c. 684 MHz; 133Ch. 5 – 684 MHz

Performance Data, 5 – 700 MHz (8 V)

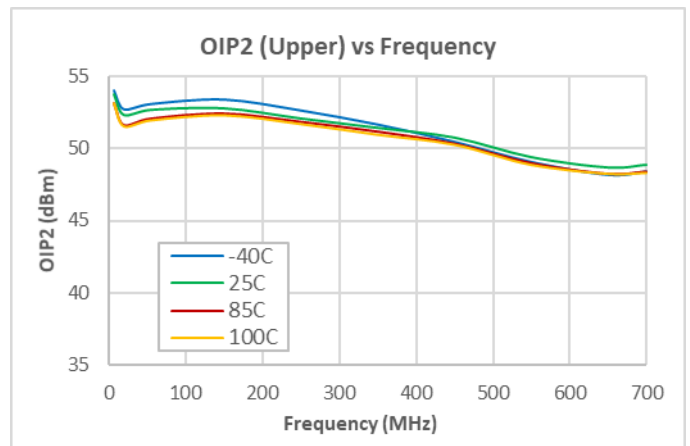
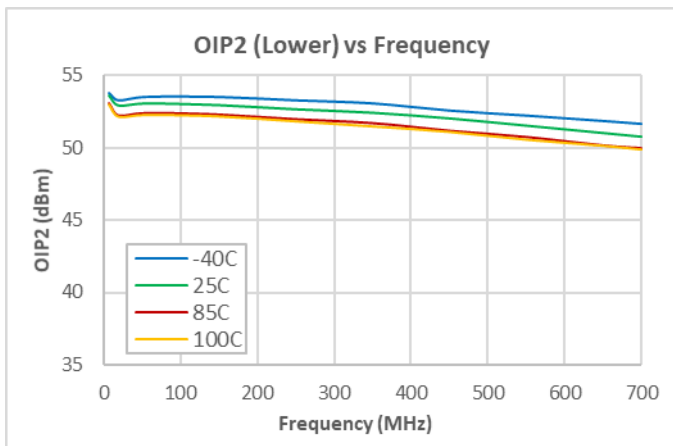
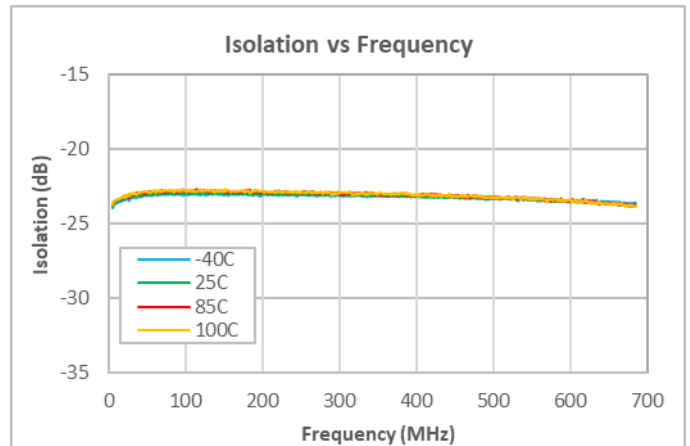
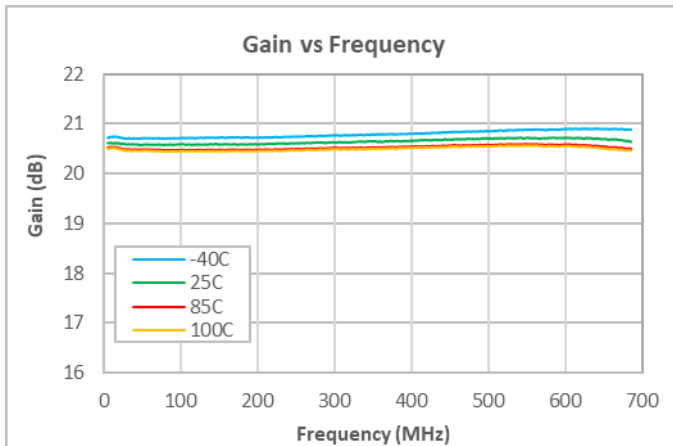
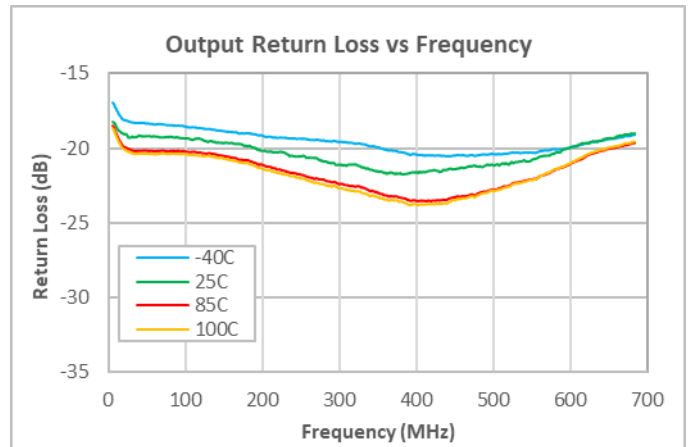
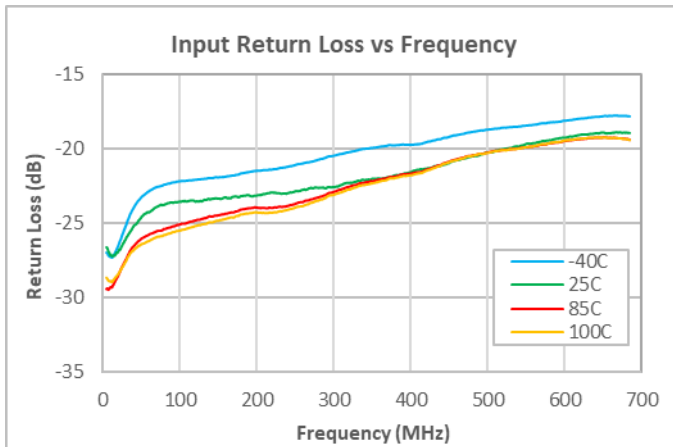

- Notes:
- (1) Temperature 25 °C, 75 ohm test system, nominal current (unless otherwise noted).
  - (2) OIP2; +9 dBm/tone output, 6 MHz spacing

### Performance Data, 5 – 700 MHz (8 V)

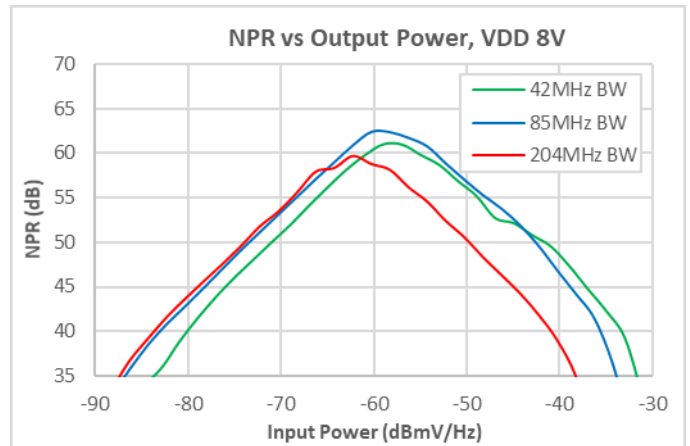
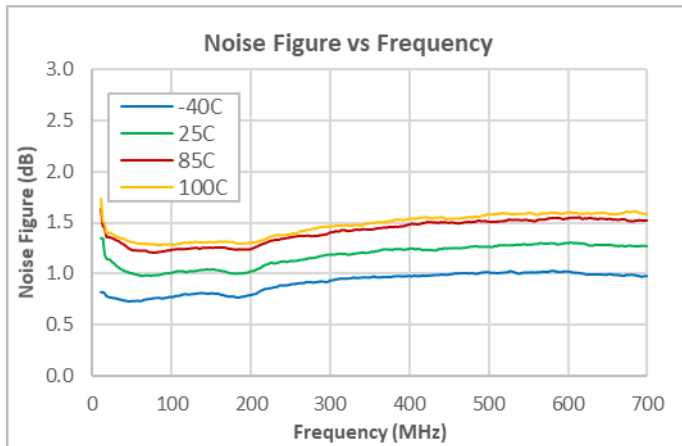
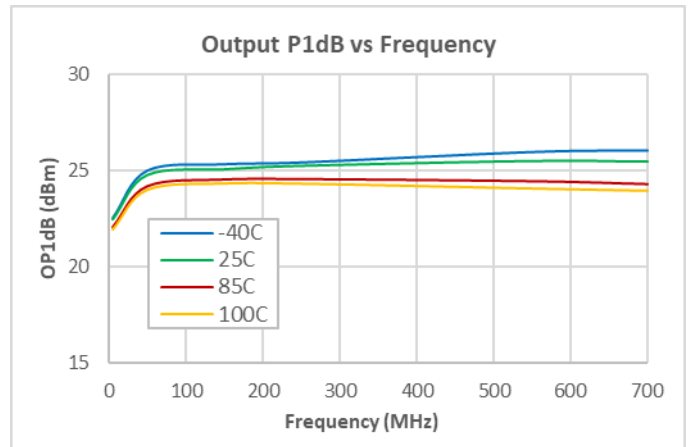
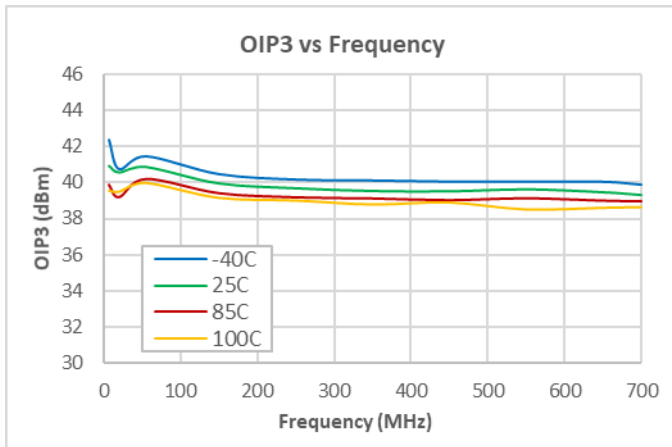

**Notes:**

- (1) Temperature 25 °C, 75 ohm test system, nominal current (unless otherwise noted).
- (2) OIP3; +9 dBm/tone output, 6 MHz spacing

**Performance Data, 5 – 700 MHz (8 V)**

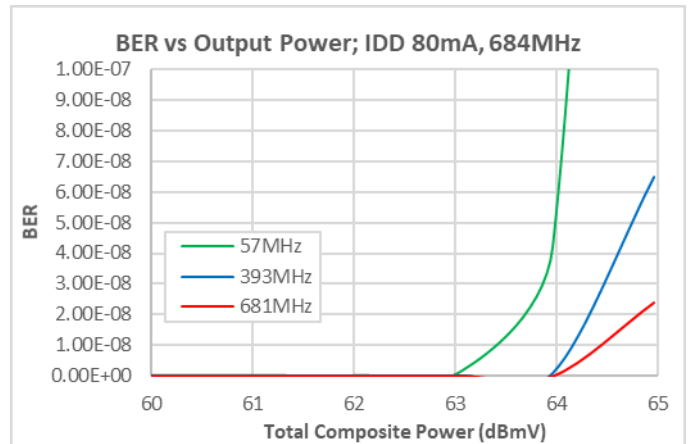
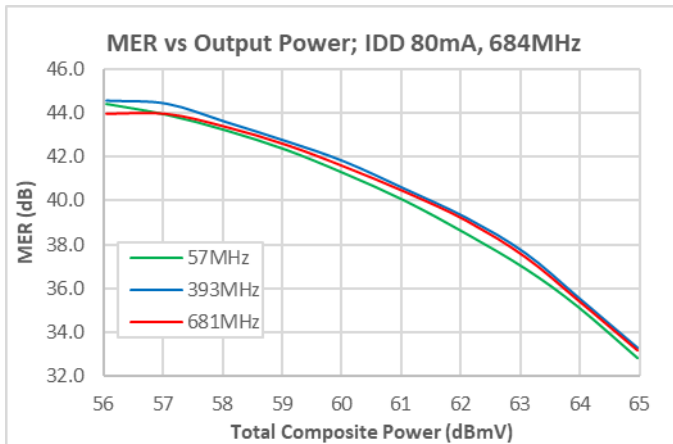
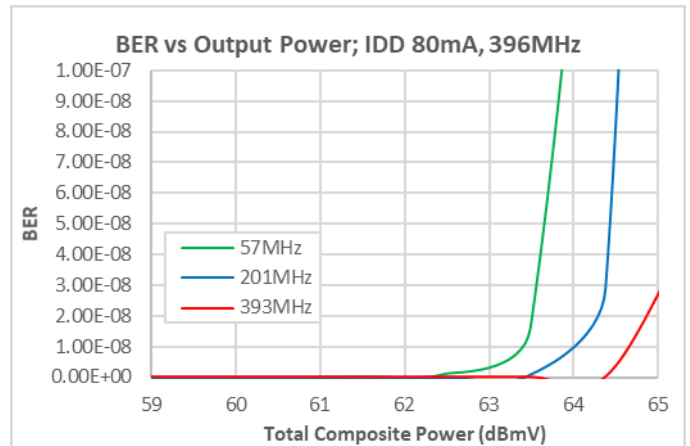
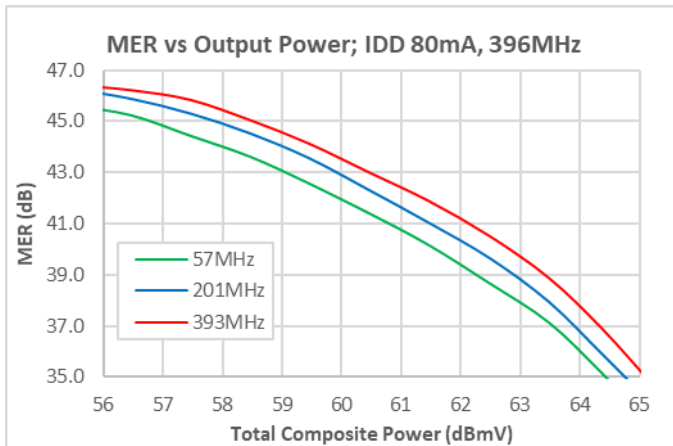
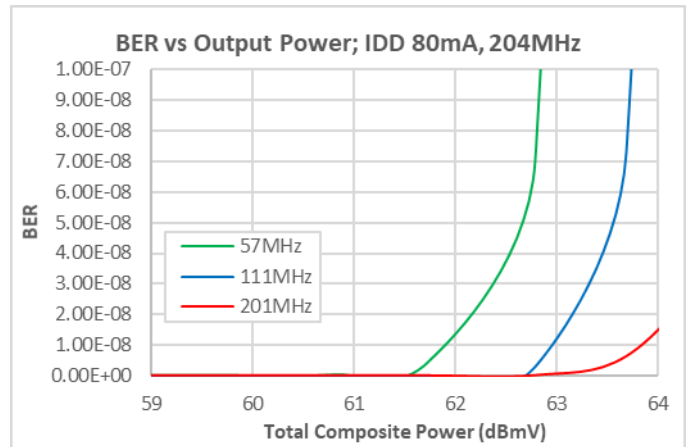
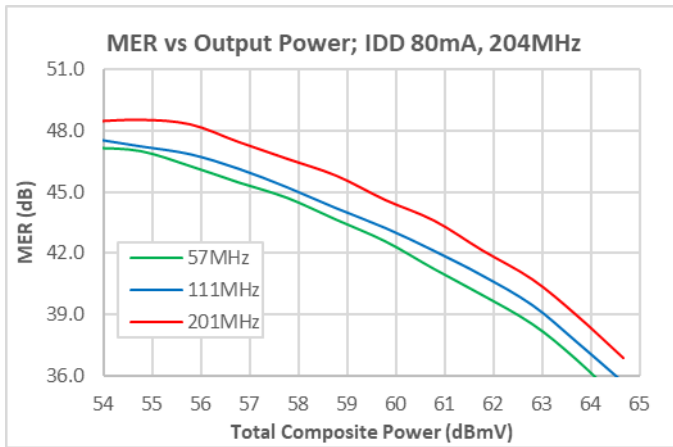

- Notes:
- (1) Temperature 25 °C, 75 ohm test system, nominal current (unless otherwise noted).
  - (2) MER/BER; 256 QAM, 0dB Tilt, ITU-T J.83, Annex B, Source Corrected, Maximum Correction 4.3 dB.
    - a. 204 MHz; 33Ch. 5 – 204 MHz
    - b. 396 MHz; 65Ch. 5 – 396 MHz
    - c. 684 MHz; 133Ch. 5 – 684 MHz



**Performance Data vs Supply Voltage, 5 – 700 MHz**

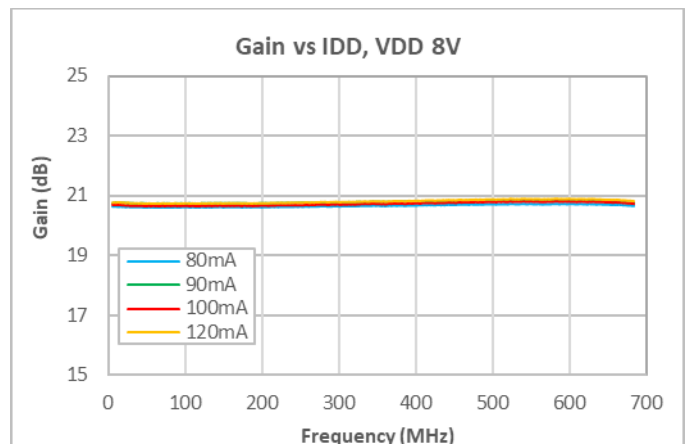
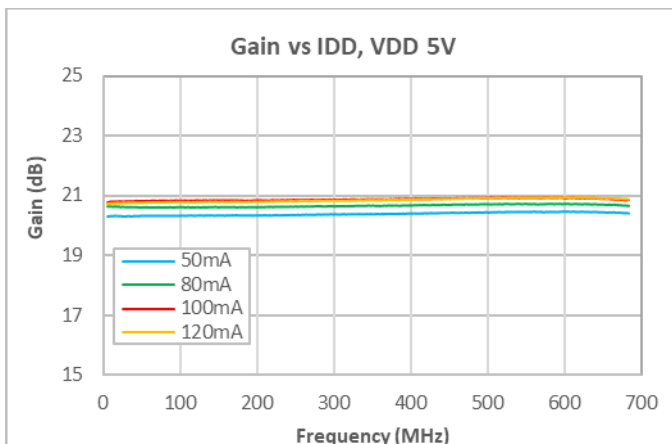
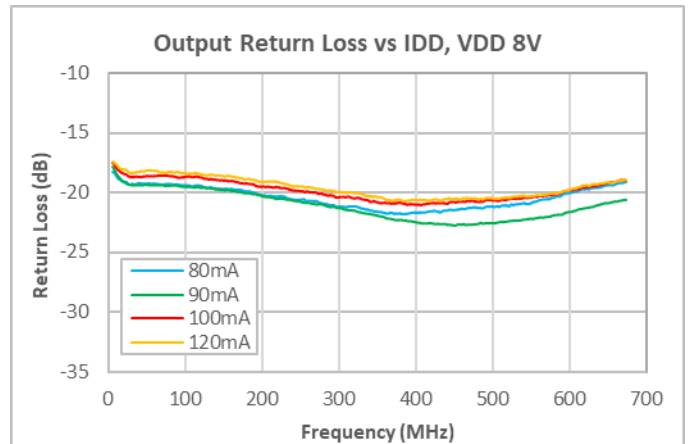
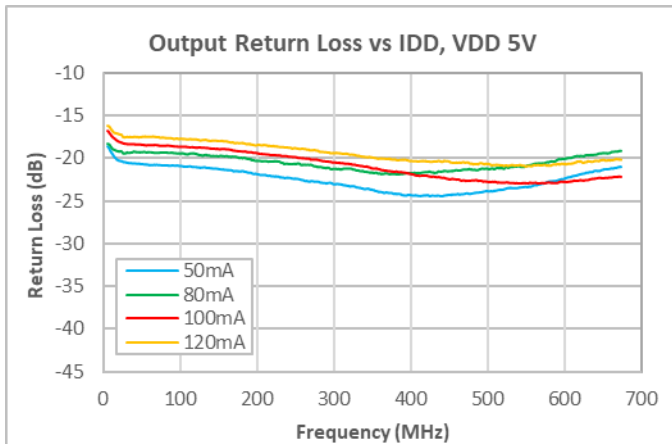
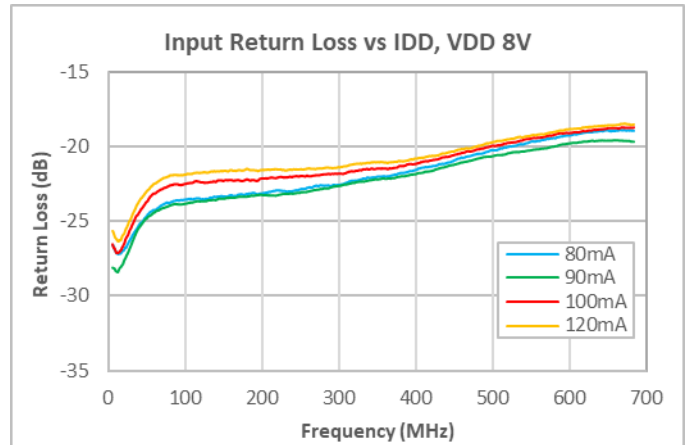
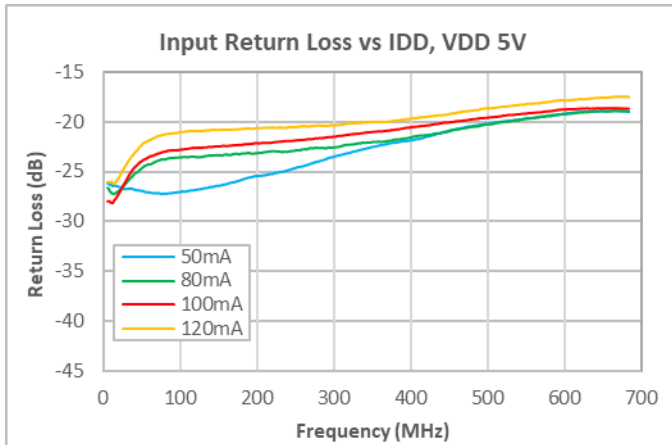

Notes:  
 (1) Temperature 25 °C, 75 ohm test system, nominal current (unless otherwise noted).

**Performance Data vs Supply Voltage, 5 – 700 MHz**

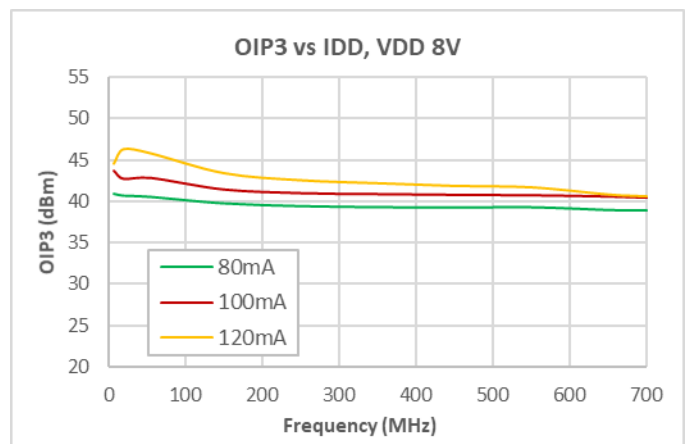
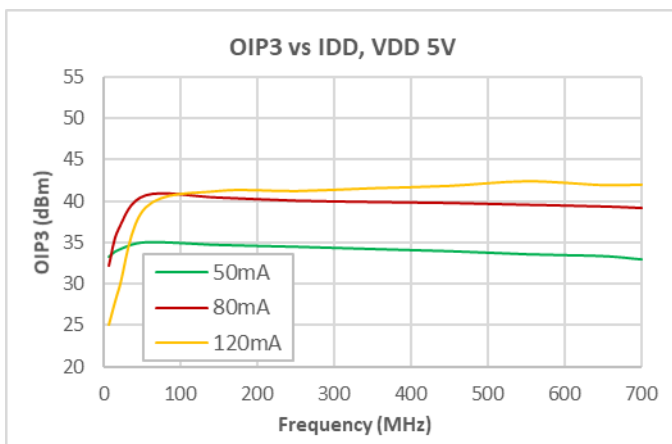
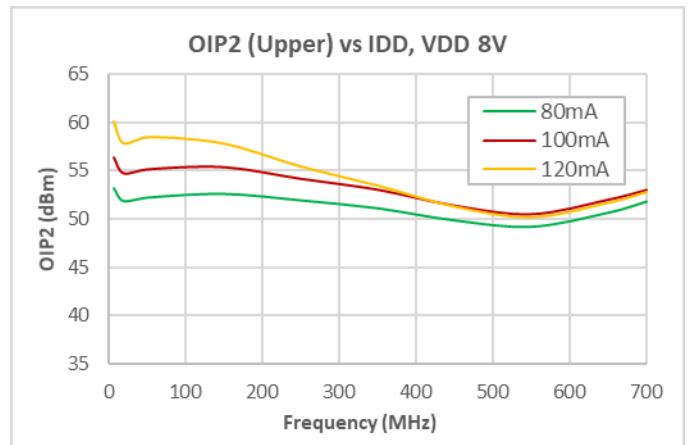
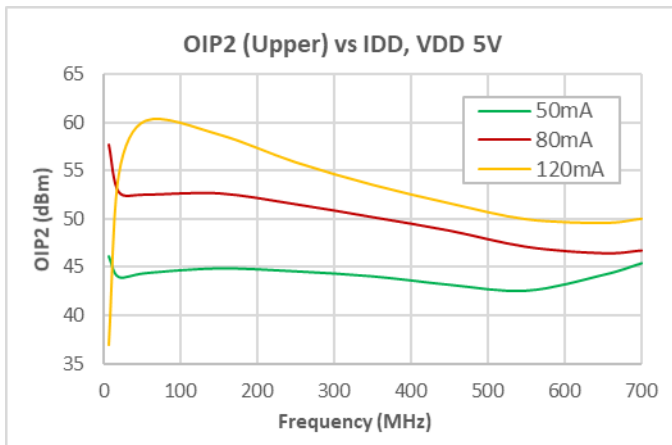
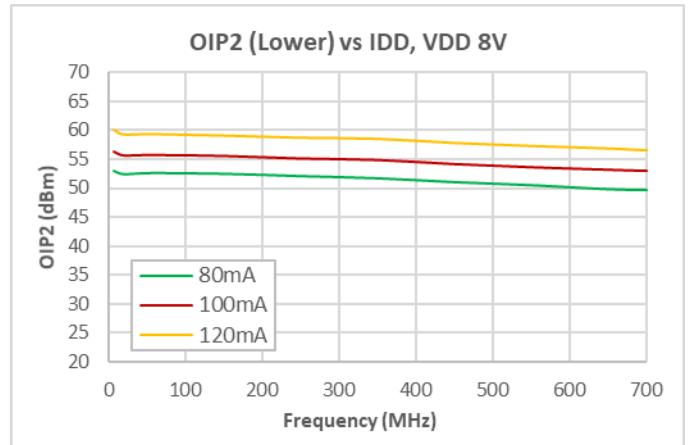
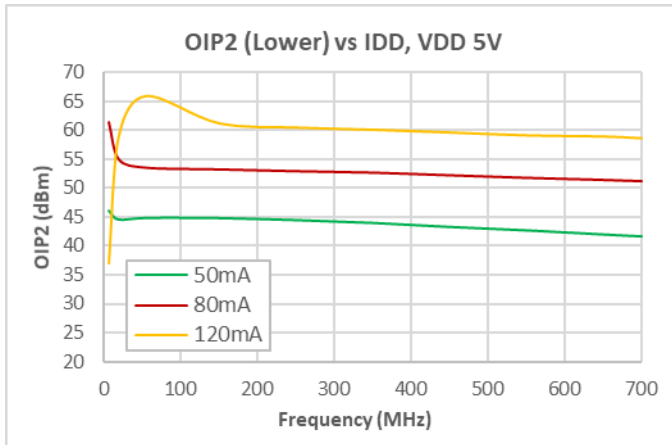

- Notes:
- (1) Temperature 25 °C, 75 ohm test system, nominal current (unless otherwise noted).
  - (2) OIP2; 9 dBm/tone.
  - (3) OIP3; 9 dBm/tone

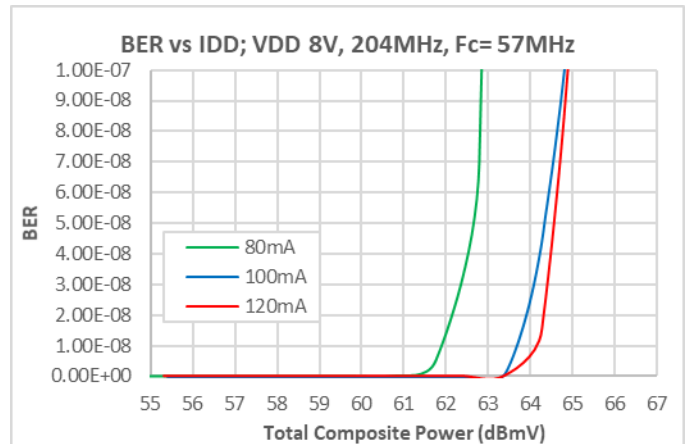
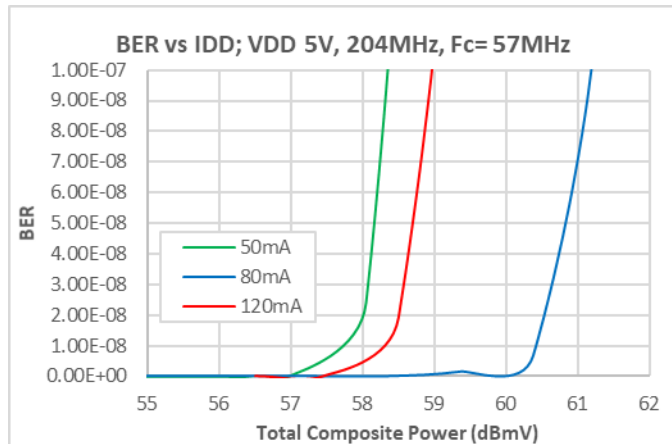
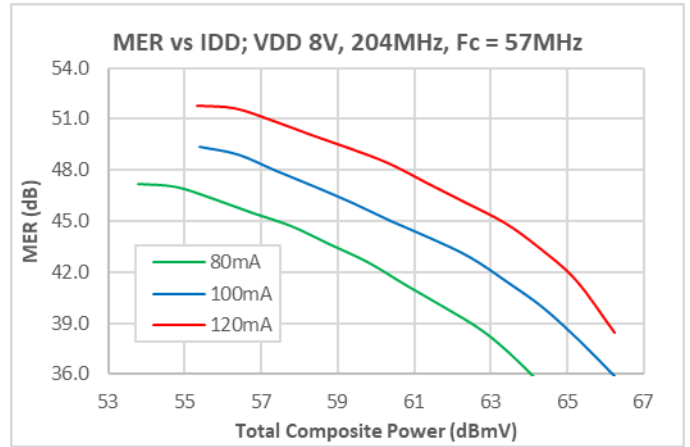
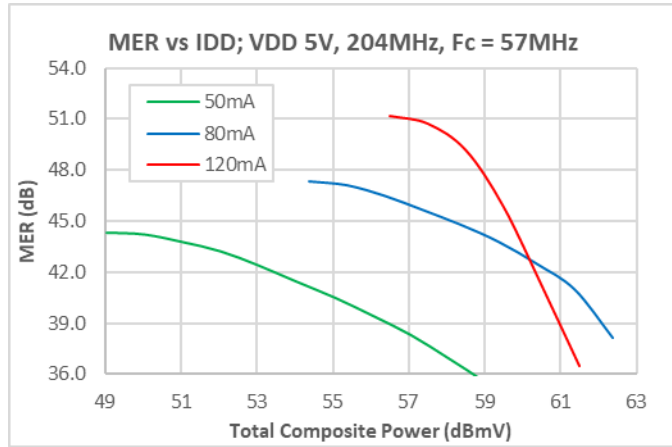
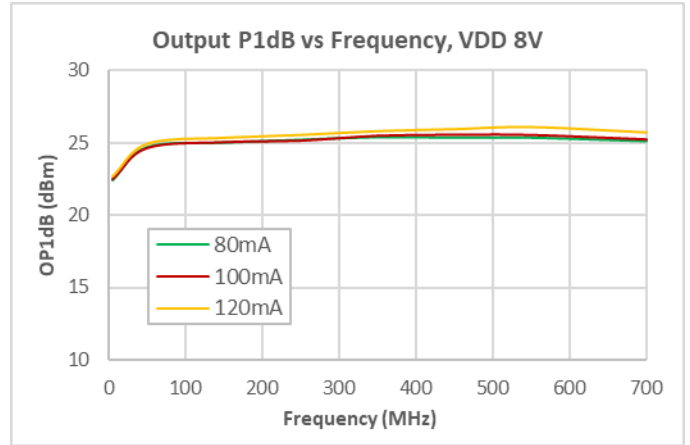
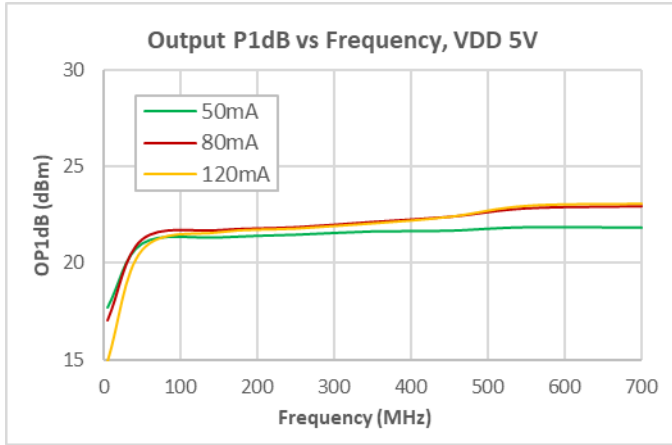
**Performance Data vs Supply Voltage, 5 – 700 MHz**

- Notes:
- (1) Temperature 25 °C, 75 ohm test system, nominal current (unless otherwise noted).
  - (2) MER/BER; 256 QAM, 0dB Tilt, ITU-T J.83, Annex B, Source Corrected, Maximum Correction 4.3 dB.
    - a. 204 MHz; 33Ch. 5 – 204 MHz
    - b. 396 MHz; 65Ch. 5 – 396 MHz
    - c. 684 MHz; 133Ch. 5 – 684 MHz

**Performance Data vs Supply Voltage, 5 – 700 MHz**

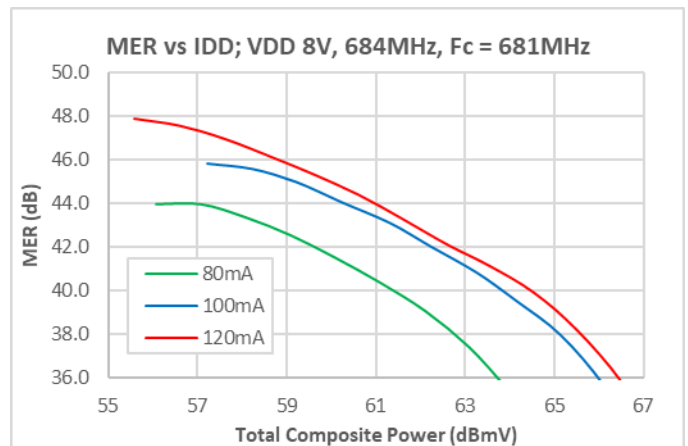
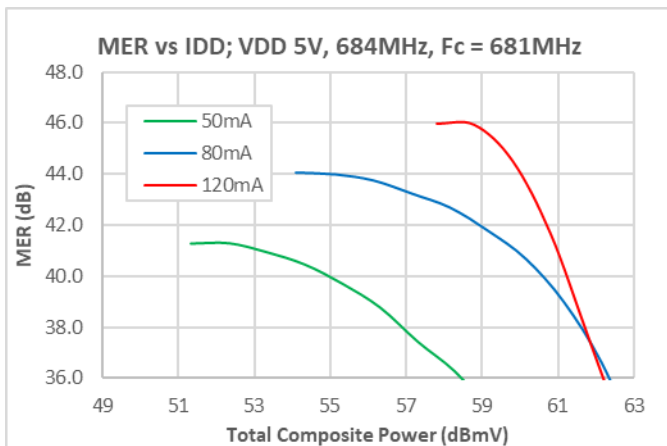
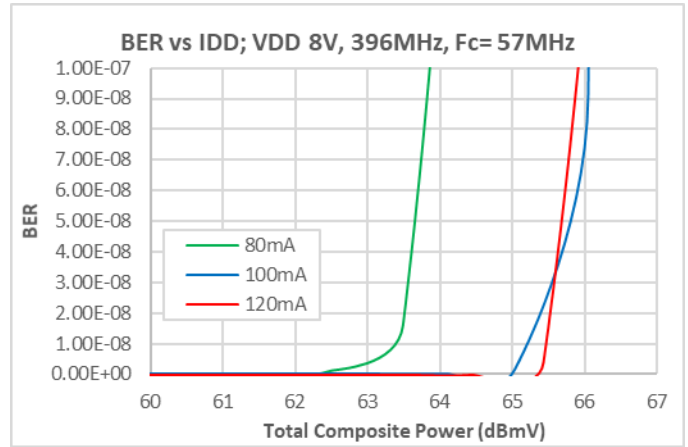
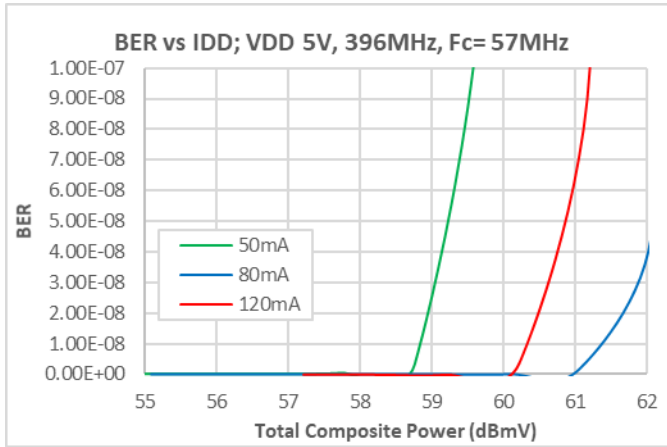
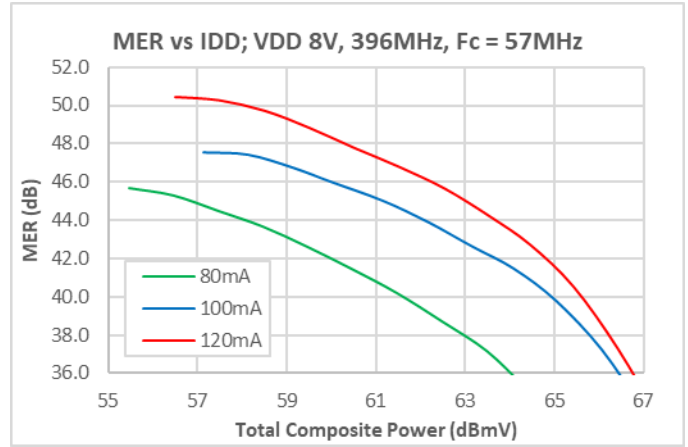
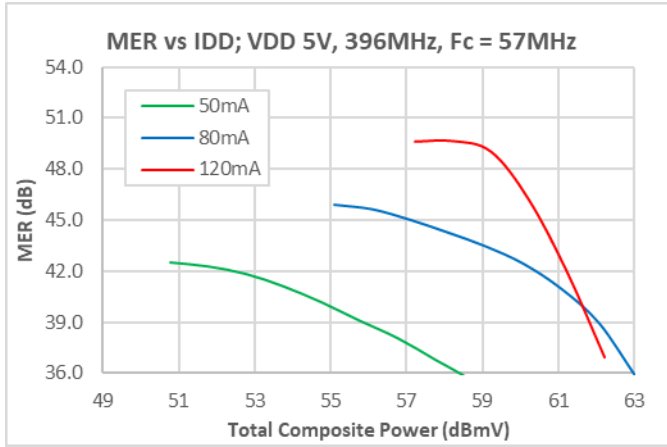

- Notes:
- (1) Temperature 25 °C, 75 ohm test system, nominal current (unless otherwise noted).
  - (2) MER/BER; 256 QAM, 0dB Tilt, ITU-T J.83, Annex B, Source Corrected, Maximum Correction 4.3 dB.
    - a. 204 MHz; 33Ch. 5 – 204 MHz
    - b. 396 MHz; 65Ch. 5 – 396 MHz
    - c. 684 MHz; 133Ch. 5 – 684 MHz

**Performance Data vs Supply Voltage, 5 – 700 MHz**

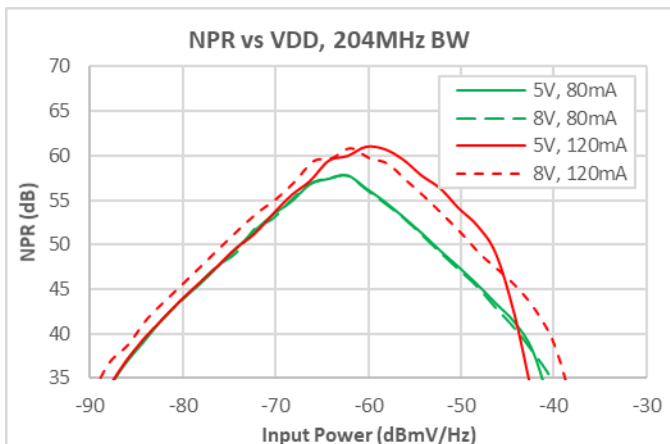
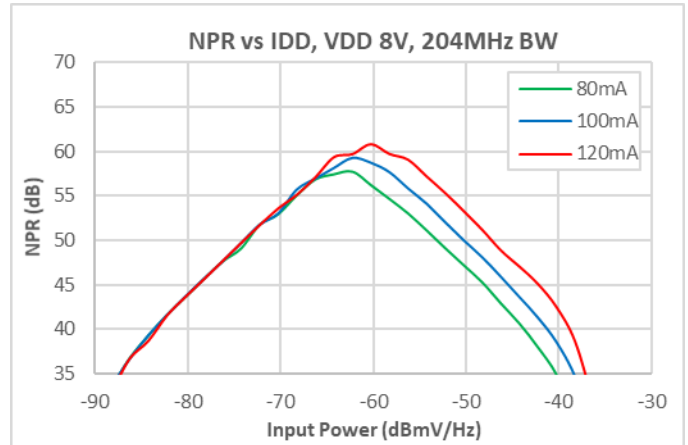
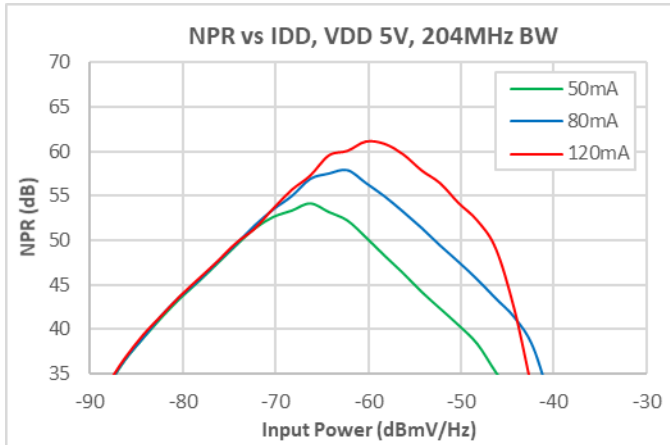
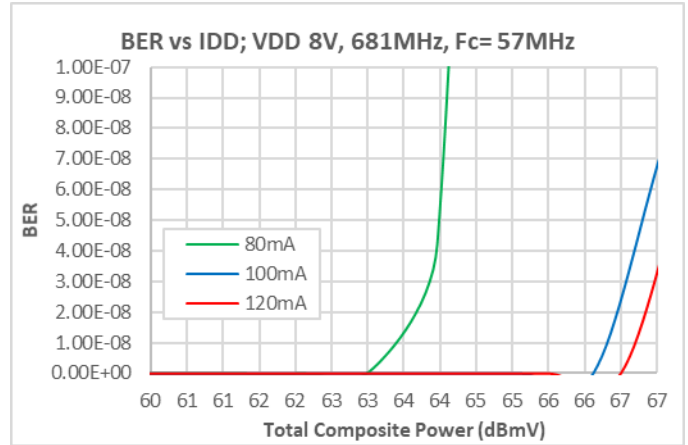
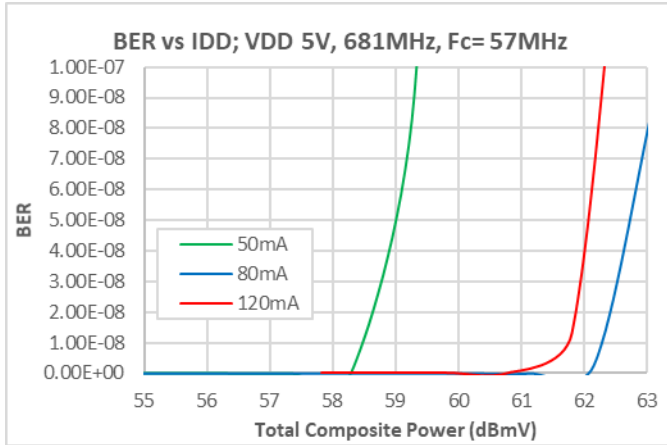

**Notes:**

- (1) Temperature 25 °C, 75 ohm test system, nominal current (unless otherwise noted).
- (2) MER/BER; 256 QAM, 0dB Tilt, ITU-T J.83, Annex B, Source Corrected, Maximum Correction 4.3 dB.
  - a. 204 MHz; 33Ch. 5 – 204 MHz
  - b. 396 MHz; 65Ch. 5 – 396 MHz
  - c. 684 MHz; 133Ch. 5 – 684 MHz

## Pin Configuration and Description

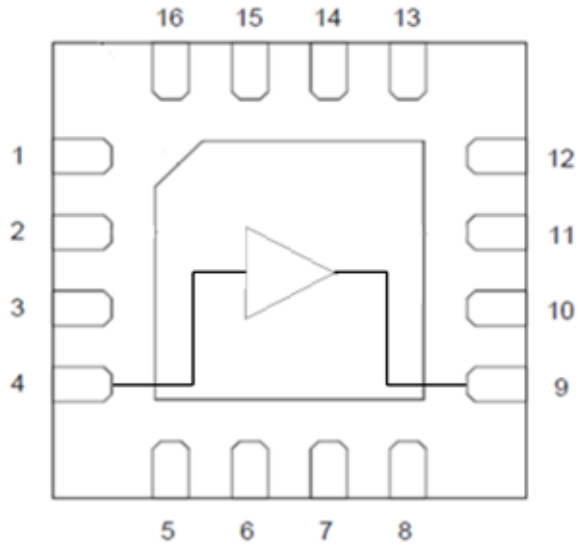

Top View

Pin Number	Label	Description
4	RF IN	RF Input, DC blocking capacitor required.
9	RF OUT / VDD	RF Output – VDD bias choke required.
1 - 3, 5-8, 10-16	GND	Internally Not Connected.
Backside Paddle	GND	Ground. Use recommended via pattern to minimize inductance and thermal resistance. See PCB Mounting Pattern for suggested footprint.

### Package Outline

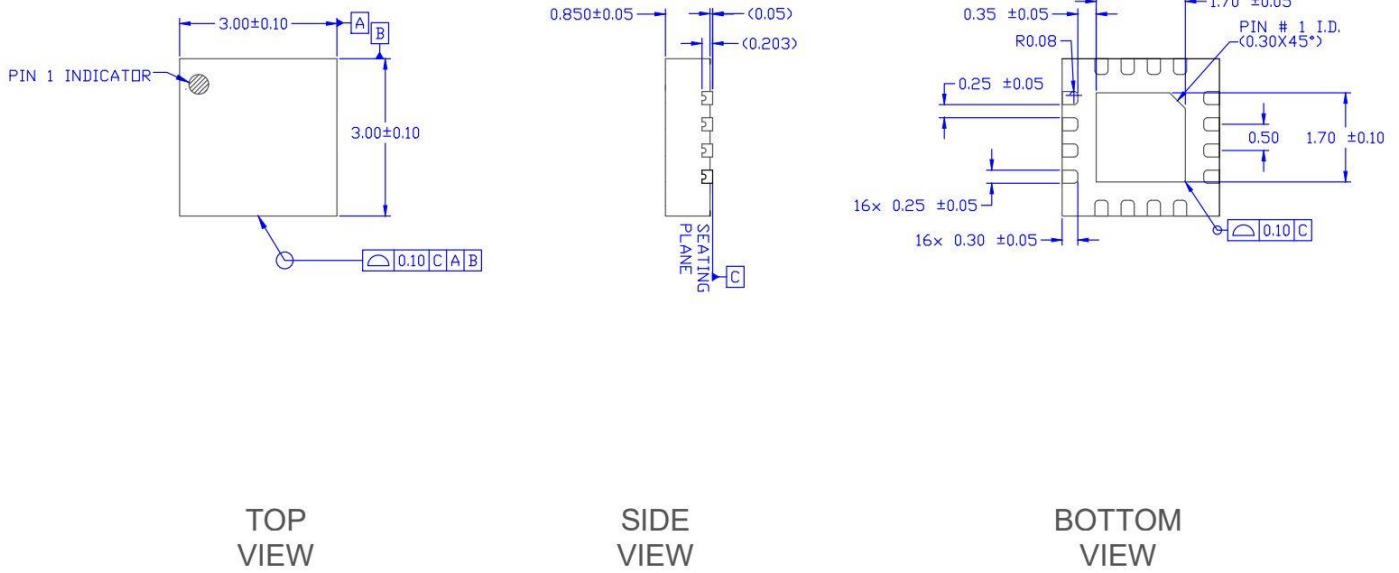

### Recommended Mounting Pattern

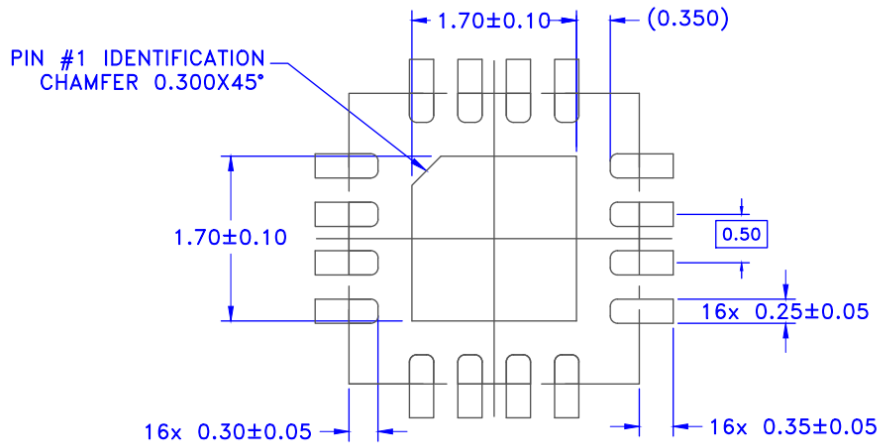

## Package Marking

---

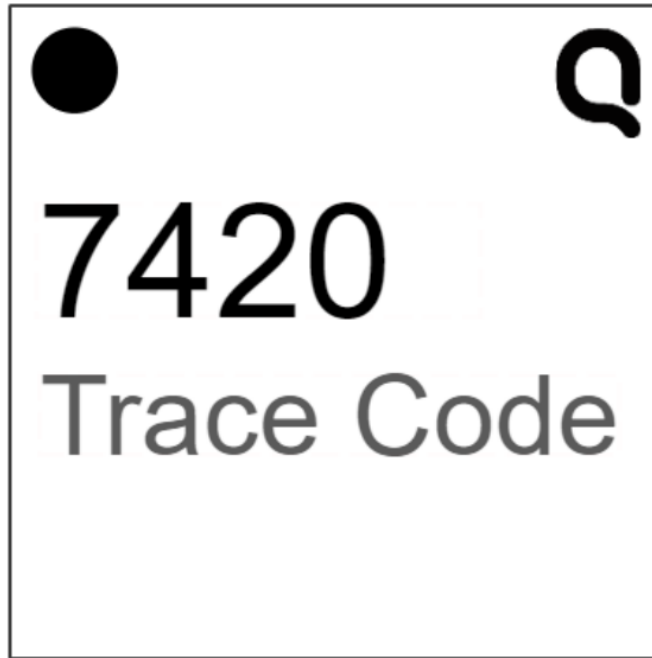

- Pin 1 Indicator  
Qorvo Logo - Use Q5D  
Trace Code to be assigned by SubCon



## Handling Precautions

Parameter	Rating	Standard
ESD – Human Body Model (HBM)	Class 1B (500V to < 1000V)	ANSI/ESDA/JEDEC JS-001
ESD – Charged Device Model (CDM)	Class C3 (≥1000V)	ANSI/ESDA/JEDEC JS-002
MSL – Moisture Sensitivity Level	Level 2	IPC/JEDEC J-STD-020



Caution!  
ESD-Sensitive  
Device

## Solderability

Compatible with both lead-free (260 °C max. reflow temp.) and tin/lead (245 °C max. reflow temp.) soldering processes. Solder profiles available upon request.

Contact plating: NiPdAu

## RoHS Compliance

This part is compliant with 2011/65/EU RoHS directive (Restrictions on the Use of Certain Hazardous Substances in Electrical and Electronic Equipment) as amended by Directive 2015/863/EU.

This product also has the following attributes:

- Lead Free
- Halogen Free (Chlorine, Bromine)
- Antimony Free
- TBBP-A (C<sub>15</sub>H<sub>12</sub>Br<sub>4</sub>O<sub>2</sub>) Free
- PFOS Free
- SVHC Free



## Contact Information

For the latest specifications, additional product information, worldwide sales and distribution locations:

**Tel: 1-844-890-8163**

**Web: [www.qorvo.com](http://www.qorvo.com)**

**Email: [customer.support@qorvo.com](mailto:customer.support@qorvo.com)**

## Important Notice

The information contained in this Data Sheet and any associated documents (“Data Sheet Information”) is believed to be reliable; however, Qorvo makes no warranties regarding the Data Sheet Information and assumes no responsibility or liability whatsoever for the use of said information. All Data Sheet Information is subject to change without notice. Customers should obtain and verify the latest relevant Data Sheet Information before placing orders for Qorvo® products. Data Sheet Information or the use thereof does not grant, explicitly, implicitly or otherwise any rights or licenses to any third party with respect to patents or any other intellectual property whether with regard to such Data Sheet Information itself or anything described by such information.

DATA SHEET INFORMATION DOES NOT CONSTITUTE A WARRANTY WITH RESPECT TO THE PRODUCTS DESCRIBED HEREIN, AND QORVO HEREBY DISCLAIMS ANY AND ALL WARRANTIES WITH RESPECT TO SUCH PRODUCTS WHETHER EXPRESS OR IMPLIED BY LAW, COURSE OF DEALING, COURSE OF PERFORMANCE, USAGE OF TRADE OR OTHERWISE, INCLUDING THE IMPLIED WARRANTIES OF MERCHANTABILITY AND FITNESS FOR A PARTICULAR PURPOSE. Without limiting the generality of the foregoing, Qorvo® products are not warranted or authorized for use as critical components in medical, life-saving, or life-sustaining applications, or other applications where a failure would reasonably be expected to cause severe personal injury or death. Applications described in the Data Sheet Information are for illustrative purposes only. Customers are responsible for validating that a particular product described in the Data Sheet Information is suitable for use in a particular application.

© 2023 Qorvo US, Inc. All rights reserved. This document is subject to copyright laws in various jurisdictions worldwide and may not be reproduced or distributed, in whole or in part, without the express written consent of Qorvo US, Inc. | QORVO® is a registered trademark of Qorvo US, Inc.