

Small switching (−30V, −1A)

QS6U24

●Features

- 1) The QS6U24 combines Pch Treueh MOSFET with a Schottky barrier diode in a single TSMT6 package.
- 2) Pch Treueh MOSFET have a low on-state resistance with a fast switching.
- 3) Pch Treueh MOSFET is neucted a low voltage drive (4V).
- 4) The independently connected Schottky barrier diode have a low forward voltage.

●External dimensions (Units : mm)

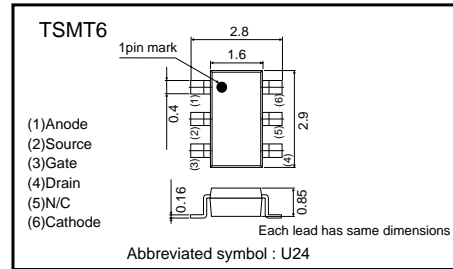

●Applications

load switch, DC/DC conversion

●Structure

Silicon P-channel MOS FET
Schottky Barrier DIODE

●Packaging specifications

Type	Package	Taping
	Code	TR
	Basic ordering unit (pieces)	3000
QS6U24		○

●Equivalent circuit

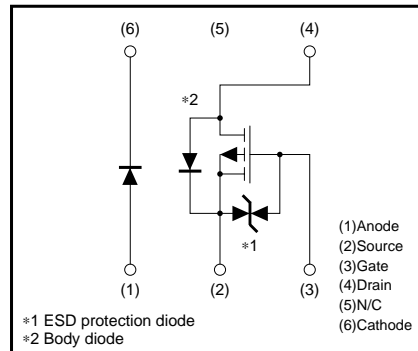

*1 A protection diode has been built in between the gate and the source to protect against static electricity when the product is in use. Use the protection circuit when rated voltages are exceeded.

●Absolute maximum ratings (Ta=25°C)

<MOSFET>

Parameter	Symbol	Limits	Unit
Drain-source voltage	V _{DSS}	−30	V
Gate-source voltage	V _{GSS}	±20	V
Drain current	Continuous	I _D	±1.0 A
	Pulsed	I _{DP}	±2.0 A *1
Source current (Body diode)	Continuous	I _S	−0.3 A
	Pulsed	I _{SP}	−1.2 A *1
Channel temperature	T _{ch}	150	°C

<Di>

Parameter	Symbol	Limits	Unit
Repetitive peak reverse voltage	V _{RM}	25	V
Reverse voltage	V _R	20	V
Forward current	I _F	0.7	A
Forward current surge peak	I _{FSM}	3.0	A *2
Junction temperature	T _J	125	°C

<MOSFET AND Di>

Parameter	Symbol	Limits	Unit
Total power dissipatino	P _d	1.0	W/Total *3
Range of strage temperature	T _{stg}	−40~+125	°C

*1 Pws<10μs, Duty cycle<1% *2 60Hz-1cyc. *3 Total mounted on a ceramic board

Transistor

●Electrical characteristics (Ta=25°C)

<MOSFET>

Parameter	Symbol	Min.	Typ.	Max.	Unit	Conditions
Gate-source leakage	I _{css}	-	-	±10	μA	V _{GS} =±20V, V _{DS} =0V
Drain-source breakdown voltage	V _{(BR)DSS}	-30	-	-	V	I _D =-1mA, V _{GS} =0V
Zero gate voltage drain current	I _{DSS}	-	-	-1	μA	V _{DS} =-30V, V _{GS} =0V
Gate threshold voltage	V _{GS(th)}	-1.0	-	-2.5	V	V _{DS} =-10V, I _D =-1mA
Static drain-source on-state resistance	R _{DS(on)}	-	300	400	mΩ	I _D =-1A, V _{GS} =-10V
		-	500	700	mΩ	I _D =-0.5A, V _{GS} =-4.5V *
		-	600	800	mΩ	I _D =-0.5A, V _{GS} =-4V
Forward transfer admittance	Y _{fs}	0.5	-	-	S	V _{DS} =-10V, I _D =-0.5A *
Input capacitance	C _{iss}	-	90	-	pF	V _{DS} =-10V
Output capacitance	C _{oss}	-	25	-	pF	V _{GS} =0V
Reverse transfer capacitance	C _{rss}	-	16	-	pF	f=1MHz
Turn-on delay time	t _{d(on)}	-	9	-	ns	I _D =-0.5A *
Rise time	t _r	-	7	-	ns	V _{DD} =-15V *
Turn-off delay time	t _{d(off)}	-	18	-	ns	V _{GS} =-10V *
Fall time	t _f	-	7	-	ns	R _L =30Ω *
Total gate charge	Q _g	-	1.7	-	nC	V _{DD} =-15V
Gate-source charge	Q _{gs}	-	0.6	-	nC	V _{GS} =-5V
Gate-drain charge	Q _{gd}	-	0.4	-	nC	I _D =-1.0A

* Pulsed

●Body diode (Source-drain)

<MOSFET>

Parameter	Symbol	Min.	Typ.	Max.	Unit	Conditions
Forward voltage	V _{SD}	-	-	-1.2	V	I _S =-0.3A, V _{GS} =0V

<Di>

Parameter	Symbol	Min.	Typ.	Max.	Unit	Conditions
Forward voltage drop	V _F	-	-	0.49	V	I _F =0.7A
Reverse leakage	I _R	-	-	200	μA	V _R =20V

●Electrical characteristic curves

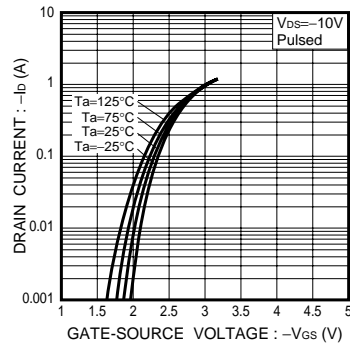

Fig.1 Typical Transfer Characteristics

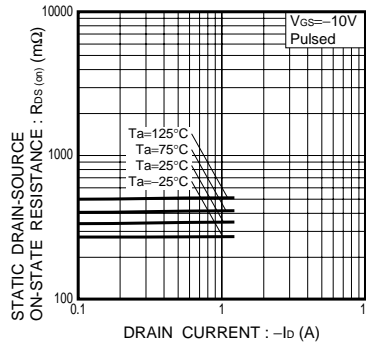

Fig.2 Static Drain-Source On-State Resistance vs. Drain Current (I)

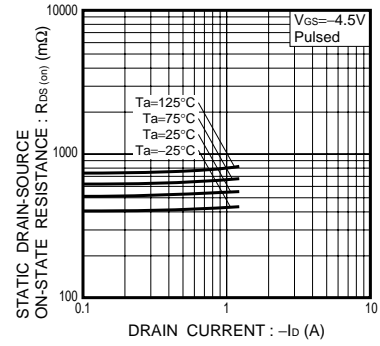

Fig.3 Static Drain-Source On-State Resistance vs. Drain Current (II)

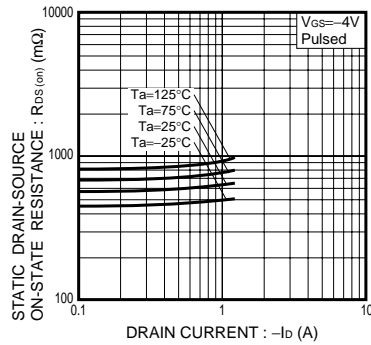

Fig.4 Static Drain-Source On-State Resistance vs. Drain Current (III)

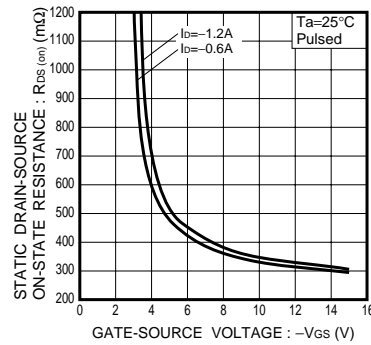

Fig.5 Static Drain-Source On-State Resistance vs. Gate-Source Voltage

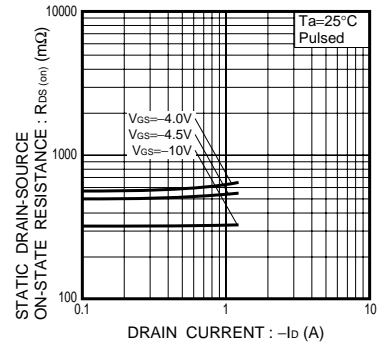

Fig.6 Static Drain-Source On-State Resistance vs. Drain Current (IV)

Transistor

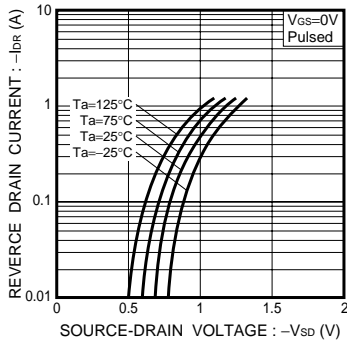

Fig.7 Reverse Drain Current vs. Source-Drain Voltage

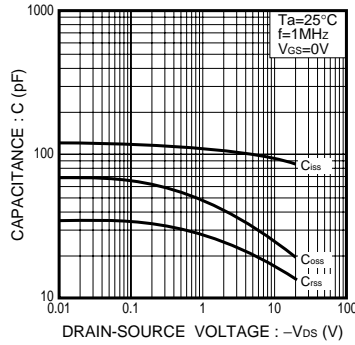

Fig.8 Typical Capacitance vs. Drain-Source Voltage

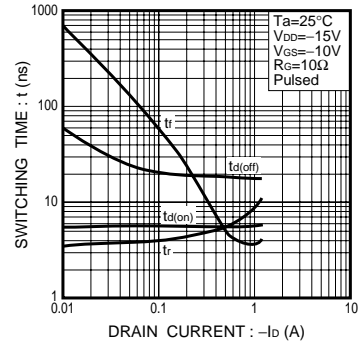

Fig.9 Switching Characteristics

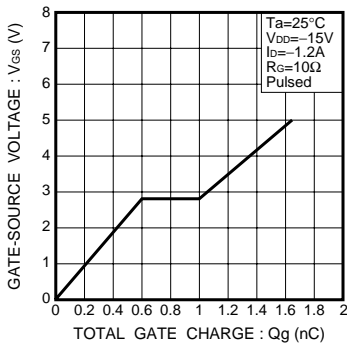

Fig.10 Dynamic Input Characteristics

●Measurement circuits

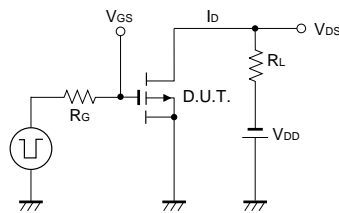

Fig.11 Switching Time Measurement Circuit

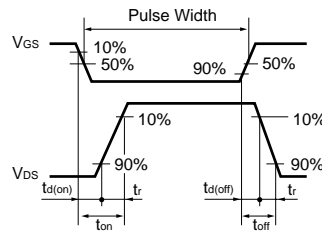

Fig.12 Switching Waveforms

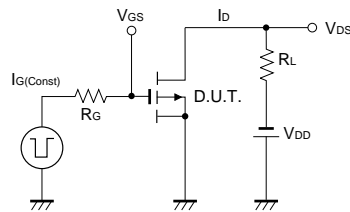

Fig.13 Gate Charge Measurement Circuit

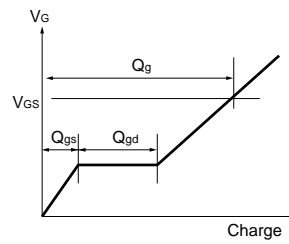

Fig.14 Gate Charge Waveforms

This datasheet has been download from:

www.datasheetcatalog.com

Datasheets for electronics components.