

Plastic Silicon OPTOLOGIC Photosensor

QSE159

Description

The QSE159 is OPTOLOGIC IC which feature a Schmitt trigger at output which provides hysteresis for noise immunity and pulse shaping. The basic building block of this IC consists of a photodiode, a linear amplifier, voltage regulator, Schmitt trigger and four output options. The TTL/LSTTL compatible output can drive up to ten TTL loads over supply currents from 4.5 to 16.0 Volts. The devices are marked with a color stripe for easy identification.

Features

- Bipolar Silicon IC
- Package Type: Sidelooker
- Medium Wide Reception Angle, 50°
- Package Material and Color: Black Epoxy
- Matched emitter: QEE113/QEE123
- Daylight Filter
- High Sensitivity
- Direct TTL/LSTTL Interface
- This is a Pb-Free Device

Block Diagram

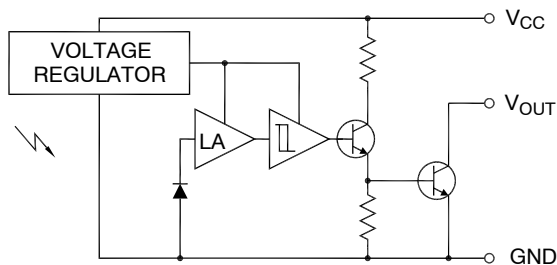
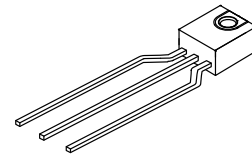

Figure 1. QSE159 Open-Collector Output Inverter



SIDELOOKER OPTOLOGIC
CASE 100CM

INPUT/OUTPUT TABLE

Part Number	Light	Output
QSE159	On	LOW
	Off	HIGH

ORDERING INFORMATION

See detailed ordering and shipping information on page 5 of this data sheet.

QSE159

MAXIMUM RATINGS (T_A = 25°C unless otherwise specified)

Symbol	Parameter	Rating	Unit
T _{OPR}	Operating Temperature	-40 to +85	°C
T _{STG}	Storage Temperature	-40 to +100	°C
T _{SOL-I}	Soldering Temperature (Iron) (Notes 2, 3, 4)	240 for 5 s	°C
T _{SOL-F}	Soldering Temperature (Flow) (Notes 2, 3)	260 for 10 s	°C
I _O	Output Current	50	mA
V _{CC}	Supply Voltage	4.0 to 16	V
V _O	Output Voltage	35	V
P _D	Power Dissipation (Note 1)	100	mW

Stresses exceeding those listed in the Maximum Ratings table may damage the device. If any of these limits are exceeded, device functionality should not be assumed, damage may occur and reliability may be affected.

1. Derate power dissipation linearly 2.50 mW/°C above 25°C.
2. RMA flux is recommended.
3. Methanol or isopropyl alcohols are recommended as cleaning agents.
4. Soldering iron 1/16" (1.6 mm) minimum from housing.

ELECTRICAL CHARACTERISTICS (T_A = -40°C to +85°C, V_{CC} = 4.5 V to 5.5 V)

Symbol	Parameter	Test Condition	Min	Typ	Max	Unit
Ee(+)	Positive Going Threshold Irradiance (Note 5)	T _A = 25°C	0.025	-	0.250	mW/cm ²
Ee(+)/Ee(-)	Hysteresis Ratio		1.10	-	2.00	
I _{CC}	Supply Current (Note 5)	Ee = 0 or 0.3 mW/cm ²	-	-	5.0	mA
	Peak to Peak Ripple which will Cause False Triggering	f = DC to 50 MHz	-	-	2.00	V

QSE159 (INVERTER OPEN COLLECTOR)

I _{OH}	High Level Output Voltage	Ee = 0, V _{OH} = 30 V	-	-	100	μA
V _{OL}	Low Level Output Voltage (Note 5)	Ee = 0.3 mW/cm ² , I _{OL} = 16 mA	-	-	0.40	V

QSE159

t _R , t _F	Output Rise, Fall Times	Ee = 0 or 0.3 mW/cm ² , f = 10 kHz, DC = 50%, R _L = 360 Ω (Note 5)	-	-	100	ns
t _{pHL} , t _{pLH}	Propagation Delay		-	6.0	-	μs

Product parametric performance is indicated in the Electrical Characteristics for the listed test conditions, unless otherwise noted. Product performance may not be indicated by the Electrical Characteristics if operated under different conditions.

5. λ = 880 nm (AlGaAs).

QSE159

TYPICAL PERFORMANCE CURVES

(Sensor Coupled to QEE113 Emitter)

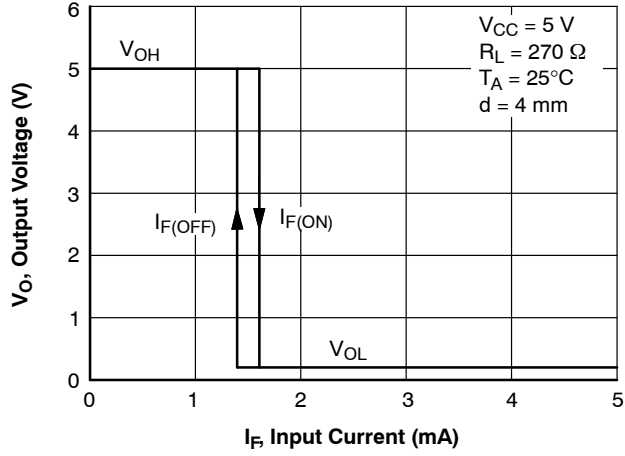

Figure 2. Output Voltage vs. Input Current

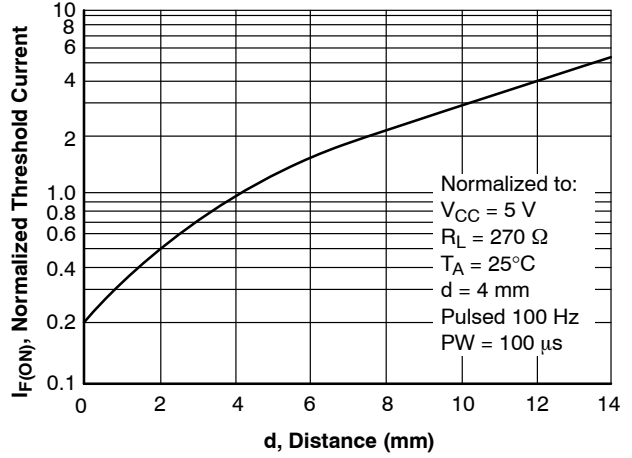

Figure 3. Threshold Current vs. Distance

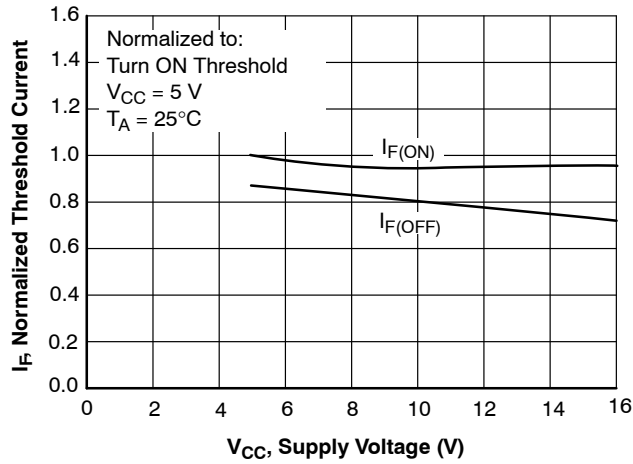

Figure 4. Normalized Threshold Current vs. Supply Voltage

TYPICAL PERFORMANCE CURVES (continued)
 (Sensor Coupled to QEE113 Emitter)

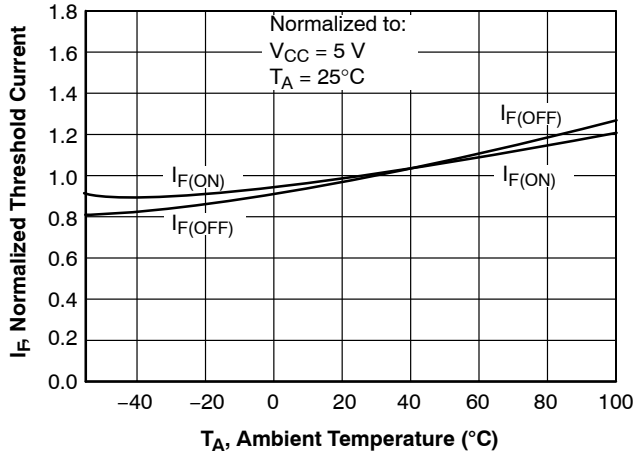

Figure 5. Normalized Threshold Current vs. Ambient Temperature

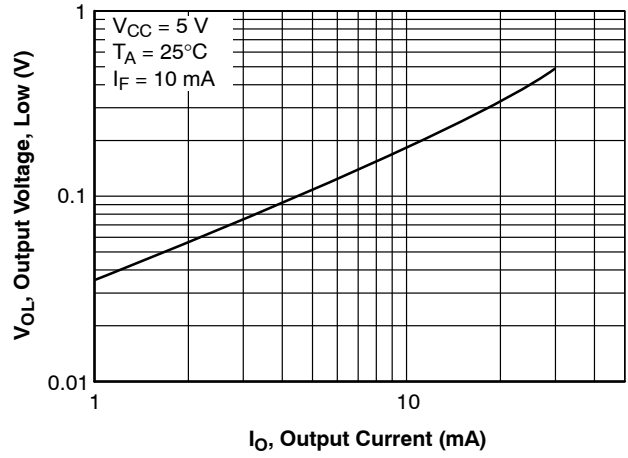

Figure 6. Low Output Voltage vs. Output Current

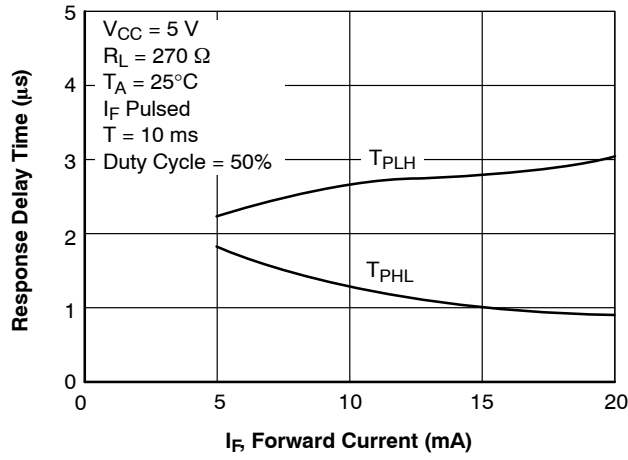
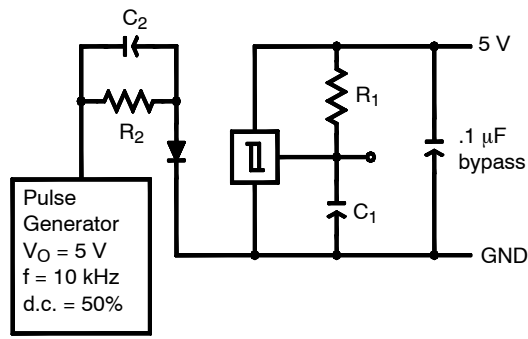

Figure 7. Response Time vs. Forward Current

QSE159



$R_1 = 360 \Omega$ $C_1 = 15 \text{ pF}$ C_1 and C_2 include probe and
 $R_2 = 180 \Omega$ $C_2 = 20 \text{ pF}$ stray wire capacitance

Figure 8. Switching Speed Test Circuit

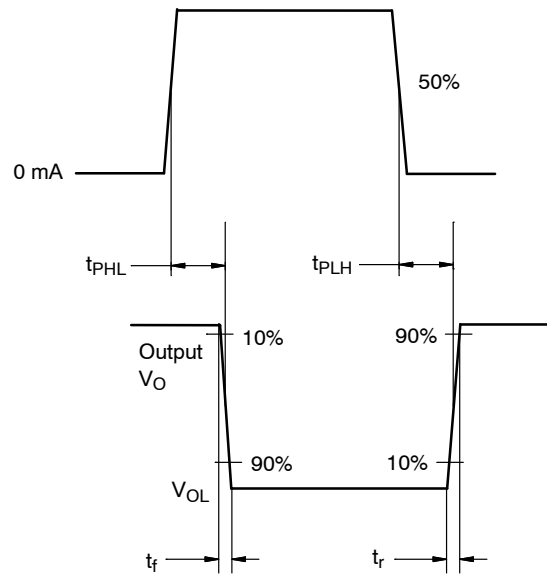
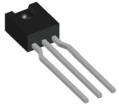

Figure 9. Switching Times Definitions

ORDERING INFORMATION

Part Number	Package	Part Number Definitions	Color Code	Shipping
QSE159	SIDELOOKER OPTOLOGIC (Pb-Free)	Open-collector, inverter output	Blue	500 Units / Bulk



SIDELOOKER OPTOLOGIC 4.44x5.08x2.54, 1.90P
CASE 100CM
ISSUE A

DATE 05 MAR 2024

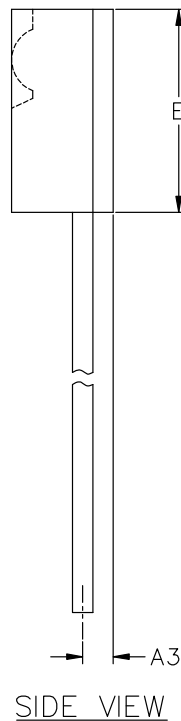
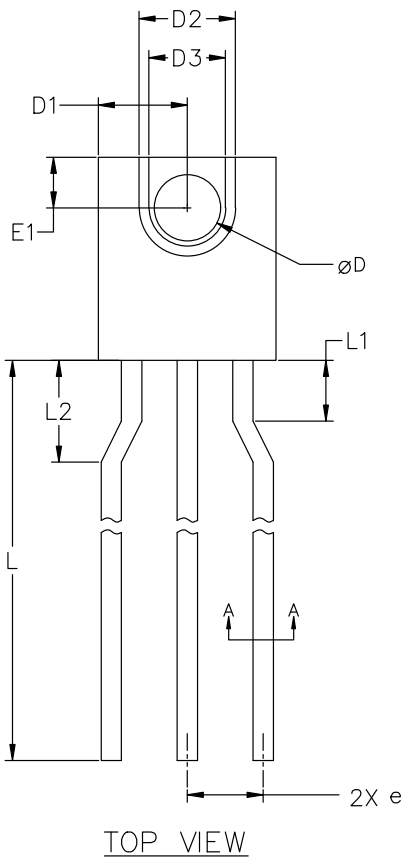
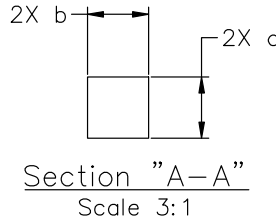
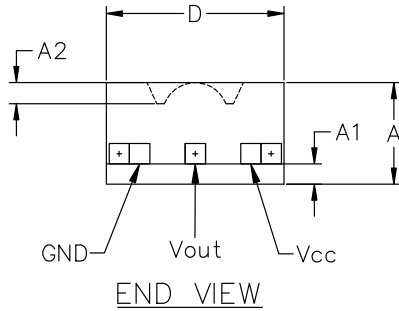

NOTES:

1. DIMENSIONING AND TOLERANCING AS PER ASMEY14.5M, 2018.
2. CONTROLLING DIMENSION: MILLIMETERS.

DIMENSION (MILLIMETERS)			
	MIN	NOM	MAX
A	2.41	2.54	2.67
A1	0.38	0.51	0.64
A2	0.48	0.53	0.58
A3	0.64	0.76	0.89
b	0.51	0.57	0.61
c	0.51	0.57	0.61
D	4.32	4.44	4.57
D1	2.16	2.21	2.29
D2	2.29	2.41	2.54
D3	1.78	1.91	2.03
E	4.83	5.08	5.33
E1	1.14	1.27	1.40
e	1.65	1.90	2.15
øD	1.52	1.65	1.78
L	12.70	13.46	---
L1	1.27	1.52	1.78
L2	2.29	2.54	2.79

DOCUMENT NUMBER:	98AON13425G	Electronic versions are uncontrolled except when accessed directly from the Document Repository. Printed versions are uncontrolled except when stamped "CONTROLLED COPY" in red.
DESCRIPTION:	SIDELOOKER OPTOLOGIC 4.44x5.08x2.54, 1.90P	PAGE 1 OF 1

onsemi and ONSEMI are trademarks of Semiconductor Components Industries, LLC dba onsemi or its subsidiaries in the United States and/or other countries. onsemi reserves the right to make changes without further notice to any products herein. onsemi makes no warranty, representation or guarantee regarding the suitability of its products for any particular purpose, nor does onsemi assume any liability arising out of the application or use of any product or circuit, and specifically disclaims any and all liability, including without limitation special, consequential or incidental damages. onsemi does not convey any license under its patent rights nor the rights of others.

onsemi, **Onsemi**, and other names, marks, and brands are registered and/or common law trademarks of Semiconductor Components Industries, LLC dba "**onsemi**" or its affiliates and/or subsidiaries in the United States and/or other countries. **onsemi** owns the rights to a number of patents, trademarks, copyrights, trade secrets, and other intellectual property. A listing of **onsemi**'s product/patent coverage may be accessed at www.onsemi.com/site/pdf/Patent-Marking.pdf. **onsemi** reserves the right to make changes at any time to any products or information herein, without notice. The information herein is provided "as-is" and **onsemi** makes no warranty, representation or guarantee regarding the accuracy of the information, product features, availability, functionality, or suitability of its products for any particular purpose, nor does **onsemi** assume any liability arising out of the application or use of any product or circuit, and specifically disclaims any and all liability, including without limitation special, consequential or incidental damages. Buyer is responsible for its products and applications using **onsemi** products, including compliance with all laws, regulations and safety requirements or standards, regardless of any support or applications information provided by **onsemi**. "Typical" parameters which may be provided in **onsemi** data sheets and/or specifications can and do vary in different applications and actual performance may vary over time. All operating parameters, including "Typicals" must be validated for each customer application by customer's technical experts. **onsemi** does not convey any license under any of its intellectual property rights nor the rights of others. **onsemi** products are not designed, intended, or authorized for use as a critical component in life support systems or any FDA Class 3 medical devices or medical devices with a same or similar classification in a foreign jurisdiction or any devices intended for implantation in the human body. Should Buyer purchase or use **onsemi** products for any such unintended or unauthorized application, Buyer shall indemnify and hold **onsemi** and its officers, employees, subsidiaries, affiliates, and distributors harmless against all claims, costs, damages, and expenses, and reasonable attorney fees arising out of, directly or indirectly, any claim of personal injury or death associated with such unintended or unauthorized use, even if such claim alleges that **onsemi** was negligent regarding the design or manufacture of the part. **onsemi** is an Equal Opportunity/Affirmative Action Employer. This literature is subject to all applicable copyright laws and is not for resale in any manner.

ADDITIONAL INFORMATION

TECHNICAL PUBLICATIONS:

Technical Library: www.onsemi.com/design/resources/technical-documentation
onsemi Website: www.onsemi.com

ONLINE SUPPORT: www.onsemi.com/support

For additional information, please contact your local Sales Representative at www.onsemi.com/support/sales