

PACKAGE DIMENSIONS

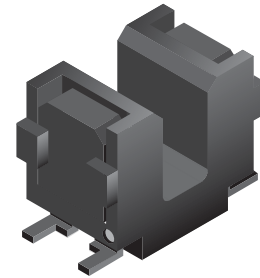

SCHEMATIC

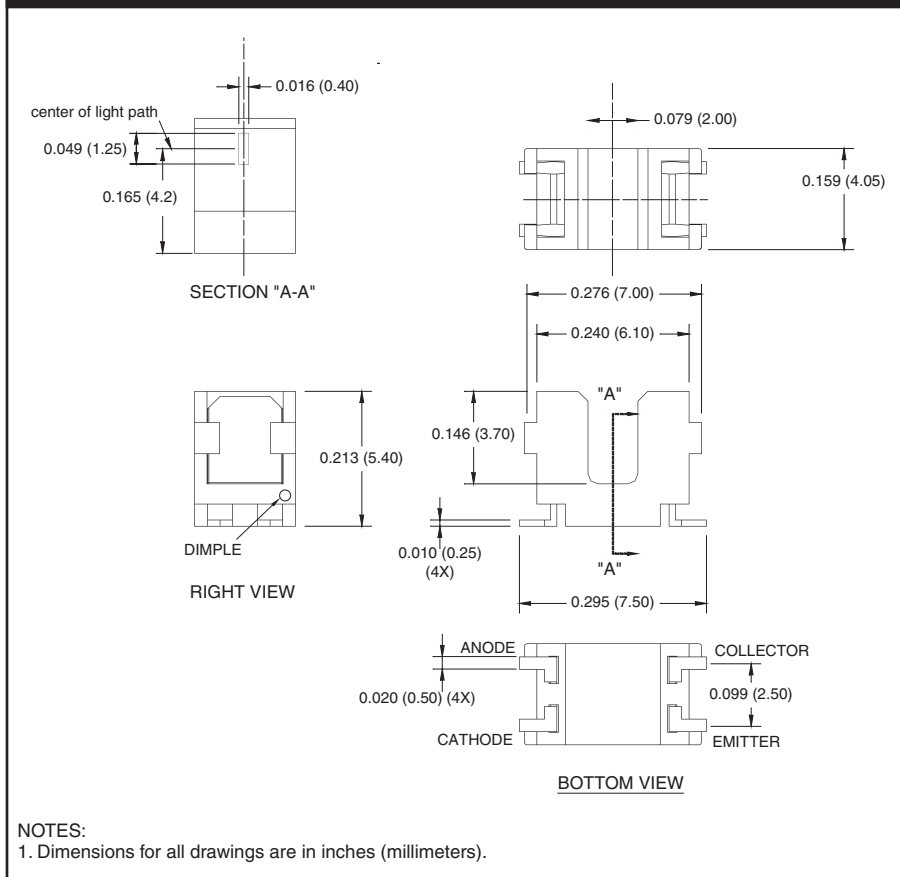
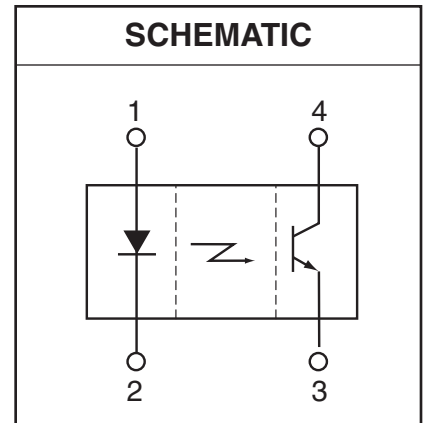

DESCRIPTION

The QVE00033 is a miniature slotted optical switch designed for surface mount applications. It consists of a GaAs LED and a silicon phototransistor facing each other across a 2mm gap, and packaged in a temperature resistant black plastic housing.

FEATURES

- No contact switching
- Transistor Output
- Compact surface mount package
- Opaque black plastic housing
- 2mm wide slot
- 0.4 mm aperture width
- Tape and reel
- Reflow conditions:
Preheat = 160°C for 120 seconds
Reflow = 200°C for 60 seconds (peak = 240°C)
- HL-94V-0 housing

ABSOLUTE MAXIMUM RATINGS ($T_A = 25^\circ\text{C}$ unless otherwise specified)			
Parameter	Symbol	Rating	Units
Operating Temperature	T_{OPR}	-55 to +100	$^\circ\text{C}$
Storage Temperature	T_{STG}	-55 to +100	$^\circ\text{C}$
Soldering Temperature (Iron)(2,3,4)	T_{SOL-I}	240 for 5 sec	$^\circ\text{C}$
Soldering Temperature (Flow)(2,3)	T_{SOL-F}	260 for 10 sec	$^\circ\text{C}$
Total Power Dissipation	P_{TOT}	100	mW
EMITTER			
Continuous Forward Current	I_F	50	mA
Reverse Voltage	V_R	6	V
Power Dissipation(1)	P_D	75	mW
SENSOR			
Collector-Emitter Voltage	V_{CEO}	30	V
Emitter-Collector Voltage	V_{ECO}	4.5	V
Collector Current	I_C	20	mA
Power Dissipation(1)	P_D	75	mW

ELECTRICAL/OPTICAL CHARACTERISTICS ($T_A = 25^\circ\text{C}$ unless otherwise specified)						
PARAMETER	TEST CONDITIONS	SYMBOL	MIN	TYP	MAX	UNITS
EMITTER						
Forward Voltage	$I_F = 20\text{ mA}$	V_F	—	1.2	1.4	V
Reverse Current	$V_R = 4\text{ V}$	I_R	—	—	10	μA
Peak Emission Wavelength	$I_F = 20\text{ mA}$	λ_{PE}	—	940	—	nm
SENSOR						
Dark Current	$V_{CE} = 20\text{ V}, I_F = 0\text{ mA}$	I_{CEO}	—	—	100	nA
COUPLED						
Collector Current	$I_F = 5\text{ mA}, V_{CE} = 5\text{ V}$	$I_{C(ON)}$	100	—	600	μA
Collector Emitter	$I_F = 10\text{ mA}, I_C = 40\text{ }\mu\text{A}$	$V_{CE(SAT)}$	—	—	0.4	V
Rise Time	$V_{CC} = 5\text{ V}, R_L = 1000\text{ }\Omega$	t_r	—	7	150	μs
Fall Time	$I_C = 100\text{ }\mu\text{A}$	t_f	—	7	150	μs

NOTES

1. Derate power dissipation linearly 1.67 mW/ $^\circ\text{C}$ above 25°C .
2. RMA flux is recommended.
3. Methanol or isopropyl alcohols are recommended as cleaning agents.
4. Soldering iron tip 1/16" (1.6mm) from housing.

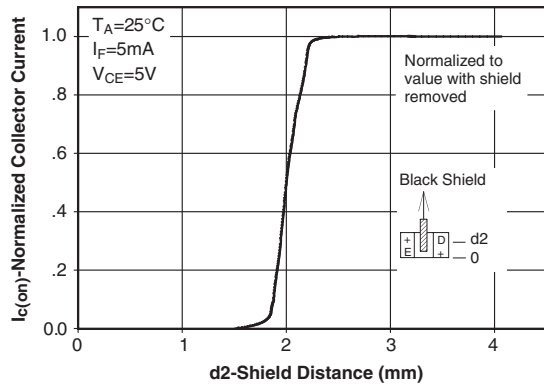

Figure 1. Normalized Collector Current Vs. Shield Distance

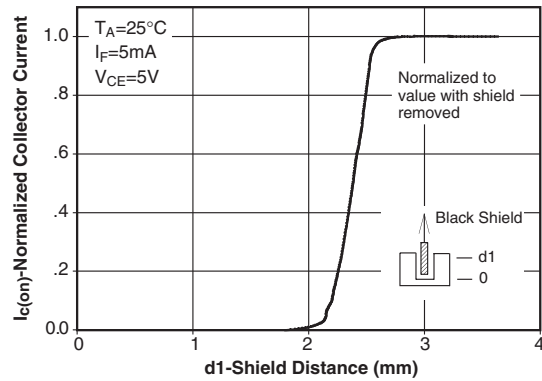

Figure 2. Normalized Collector Current Vs. Shield Distance

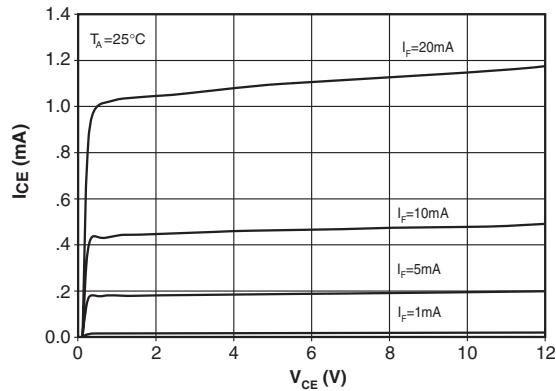

Figure 3. Collector Current Vs. Collector-Emitter Voltage

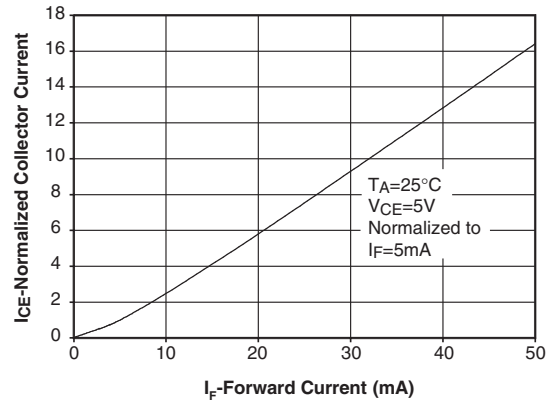

Figure 4. Normalized Collector Current Vs. Forward Current

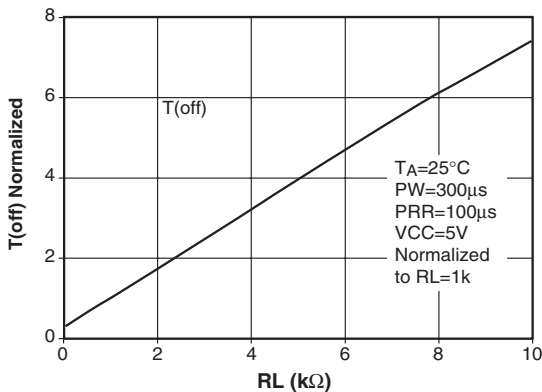

Figure 5. Rise Time vs. Load Resistance

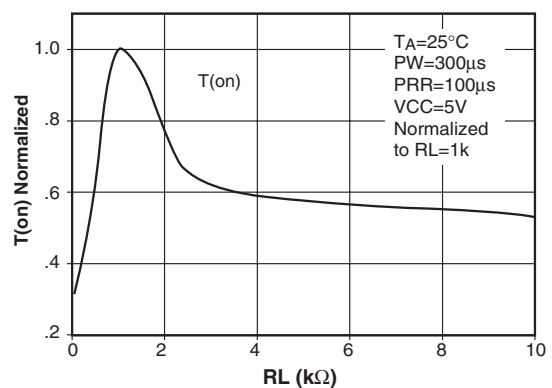
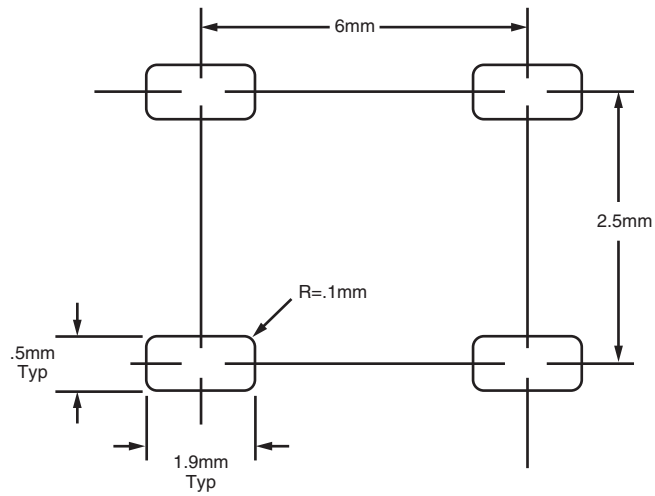

Figure 6. Fall Time vs. Load Resistance

QVE00033

RECOMMENDED PRINTED CIRCUIT BOARD PATTERN (For Reference Only)



TAPE AND REEL DIMENSIONS

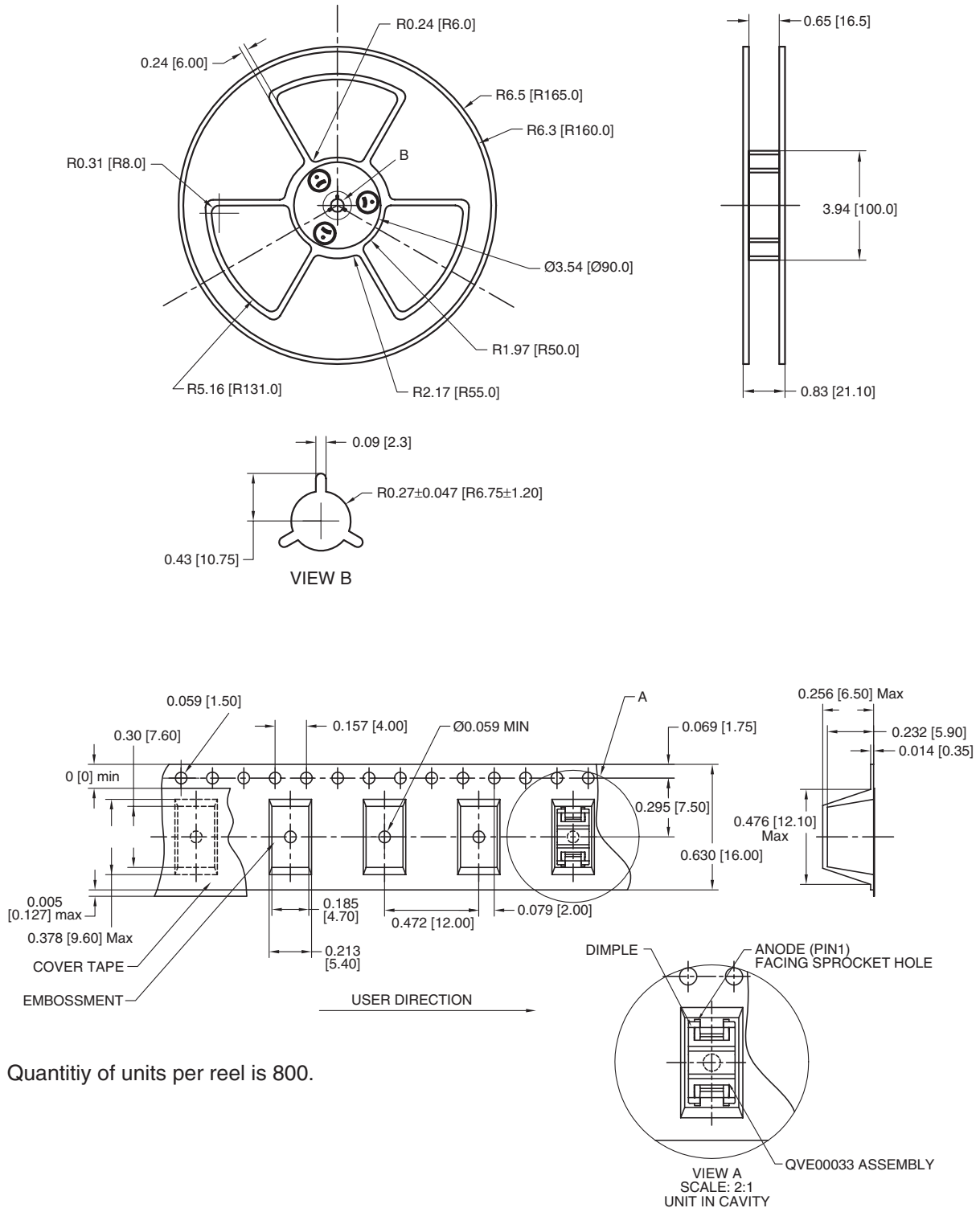

DISCLAIMER

FAIRCHILD SEMICONDUCTOR RESERVES THE RIGHT TO MAKE CHANGES WITHOUT FURTHER NOTICE TO ANY PRODUCTS HEREIN TO IMPROVE RELIABILITY, FUNCTION OR DESIGN. FAIRCHILD DOES NOT ASSUME ANY LIABILITY ARISING OUT OF THE APPLICATION OR USE OF ANY PRODUCT OR CIRCUIT DESCRIBED HEREIN; NEITHER DOES IT CONVEY ANY LICENSE UNDER ITS PATENT RIGHTS, NOR THE RIGHTS OF OTHERS.

LIFE SUPPORT POLICY

FAIRCHILD'S PRODUCTS ARE NOT AUTHORIZED FOR USE AS CRITICAL COMPONENTS IN LIFE SUPPORT DEVICES OR SYSTEMS WITHOUT THE EXPRESS WRITTEN APPROVAL OF THE PRESIDENT OF FAIRCHILD SEMICONDUCTOR CORPORATION. As used herein:

1. Life support devices or systems are devices or systems which, (a) are intended for surgical implant into the body, or (b) support or sustain life, and (c) whose failure to perform when properly used in accordance with instructions for use provided in the labeling, can be reasonably expected to result in a significant injury of the user.
2. A critical component in any component of a life support device or system whose failure to perform can be reasonably expected to cause the failure of the life support device or system, or to affect its safety or effectiveness.