

Features

- Efficiency up to 94%, Non isolated, no need for heatsinks
- SMD Package (UL94V-0 Material)
- Adjustable Output Voltage
- Wide input range.(4.75V ~ 18V)
- Short circuit protection, Thermal shutdown
- Remote On/Off Control
- Very Low Shutdown Current

Selection Guide

Part Number	Input Range (1) (V)	Output Voltage (V)	Adjust Range (V)	Output Current (A)	Efficiency	
					Min. Vin (%)	Max. Vin (%)
R-78A1.8-1.0SMD	4.75 – 18	1.8	1.5~3.3	1.0	82	71
R-78A2.5-1.0SMD	4.75 – 18	2.5	1.5~4.5	1.0	87	77
R-78A3.3-1.0SMD	4.75 – 18	3.3	1.8~5.5	1.0	91	81
R-78A5.0-1.0SMD	6.5 – 18	5.0	2.5~5.5	1.0	94	86

Description

The R-78Axx-1.0SMD series high efficiency switching regulators are ideally suited to pick-and-place mass production. The efficiency of up to 94% means that very little energy is wasted as heat. remote on/off control and adjustable output voltage are useful additional features of this versatile SMD converter series.

Specifications (typical at 25°C, 10% minimum load, unless otherwise specified)

Characteristics	Conditions	Min.	Typ.	Max.
Input Voltage Range (Note 1)	See Table	4.75		18.0V
Output Voltage Range	See Table	1.5		5.5V
Output Current	All Series	0		1000mA
Output Current Limit	All Series			3000mA
Short Circuit Input Current	All Series			30mA
Internal Power Dissipation				0.4W
Short Circuit Protection		Continuous, automatic recovery		
Output Voltage Accuracy (At 100% Load)	All Series		±2	±3%
Adjustable Voltage Range	See Table 1			±50%
Line Voltage Regulation (Vin = min to max at full load)			0.2	0.4%
Load Regulation (10% to 100% full load)			0.7	1.0%
Dynamic Load Stability	100%<->50% load		±85mV	±100mV
Ripple & Noise (20MHz BW)			20mVp-p	30mVp-p
Temperature Coefficient	-40°C~+85°C ambient			0.015%/°C
Max capacitance Load				220µF
Switching Frequency		280	350	430kHz
Quiescent Current	Vin = min. to max. at 0% load		5	7mA
Shutdown Current			20	35µA
Remote On/Off Threshold Voltage		0.8	1.2	1.6V
ON/OFF Remote Control	ON: Open or 1.6<Vr<5V, OFF: GND or 0<Vr<1.6V		Ir=1.8uA typ.	
Operating Temperature Range		-40°C		+85°C
Switch On/Off Time	(using Remote On/Off Control)			50ms
Operating Case Temperature				+100°C
Storage Temperature Range		-55°C		+125°C
Case Thermal Impedance				70°C / W
Thermal Shutdown	Internal IC junction		+160°C	
Package Weight				2.7g
MTBF (+25°C)	} Detailed Information see Application Notes chapter "MTBF"	using MIL-HDBK 217F		13338 x 10 ³ hours
(+71°C)		using MIL-HDBK 217F		3880 x 10 ³ hours

INNOLINE DC/DC-Converter

R-78Axx-1.0SMD Series

1.0 AMP SMD Single Output

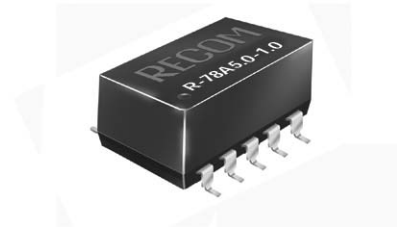

Derating-Graph (Ambient Temperature)

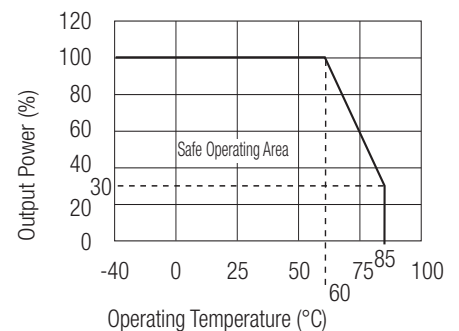

Standard Application Circuit

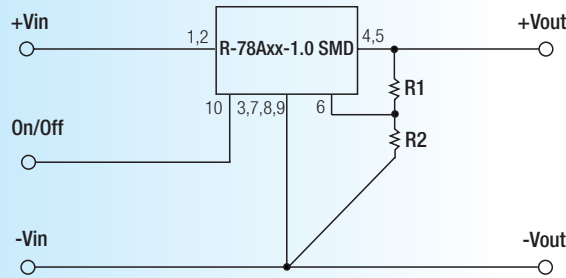

Add a blocking diode to Vout if current can flow backwards into the output, as this can damage the converter.. See Application Examples for details.

Characteristics

Efficiency

Ripple

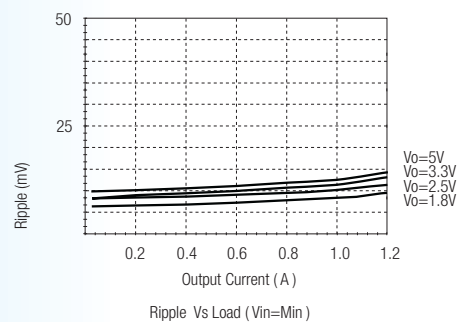
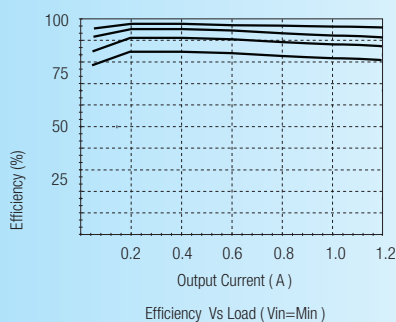
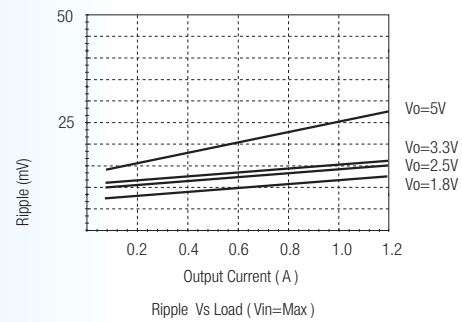
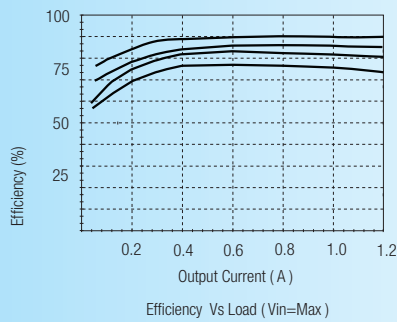
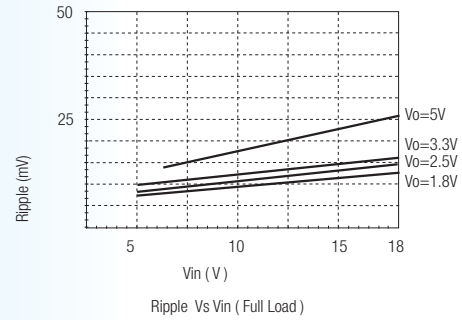
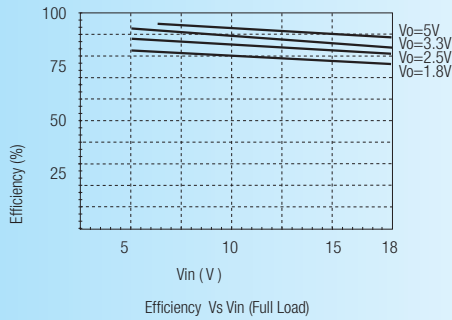

Application Examples

3.3V/5V Selectable 1A Power Supply

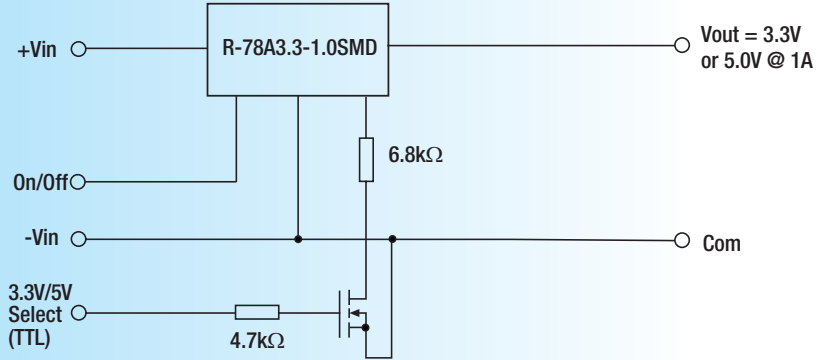

Output protection from external voltage

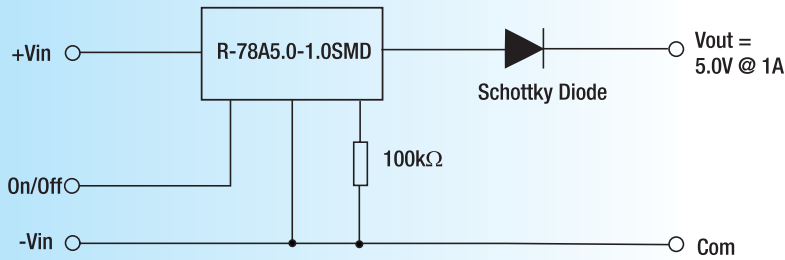

Converter output voltage set to 5.4V to compensate for Schottky diode drop

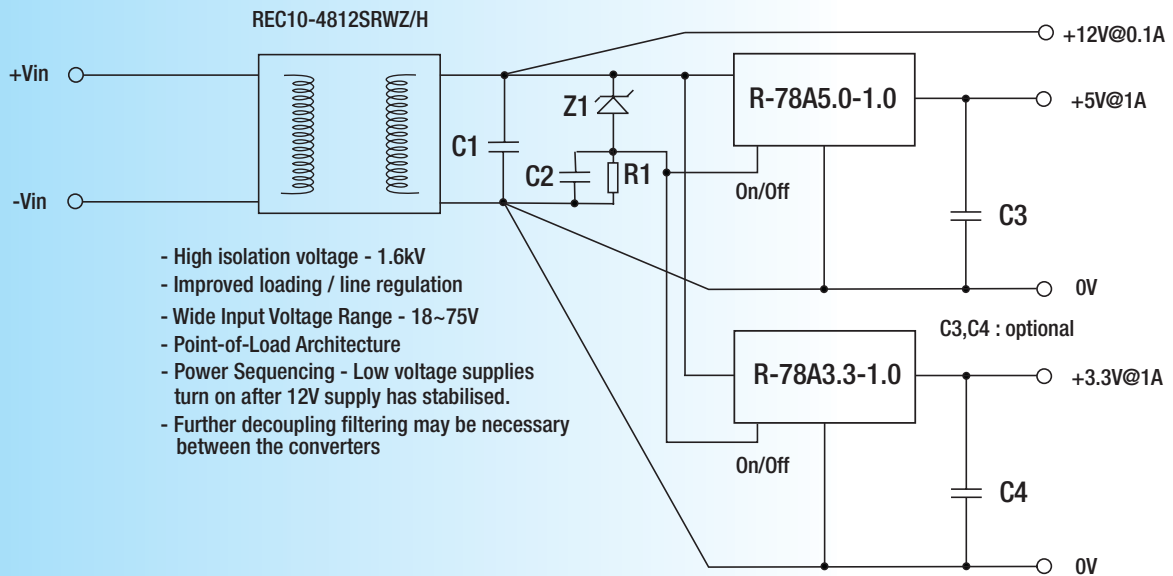

- High isolation voltage - 1.6kV
- Improved loading / line regulation
- Wide Input Voltage Range - 18~75V
- Point-of-Load Architecture
- Power Sequencing - Low voltage supplies turn on after 12V supply has stabilised.
- Further decoupling filtering may be necessary between the converters

Table 1: Adjustment Resistor Values

1.0A _{dc}	R-78A1.8-1.0SMD		R-78A2.5-1.0SMD		R-78A3.3-1.0SMD		R-78A5.0-1.0SMD	
V _{out} (nom.)	1.8V _{dc}		2.5V _{dc}		3.3V _{dc}		5.0V _{dc}	
V _{out} (adj)	R1	R2	R1	R2	R1	R2	R1	R2
1.5 (V)	3K Ω		200 Ω					
1.8 (V)			12K Ω		770 Ω			
2.5 (V)		12K Ω			21K Ω		5.6K Ω	
3.0 (V)		4.7K Ω		50K Ω	88.4K Ω		17K Ω	
3.3 (V)		2.7K Ω		29K Ω			27K Ω	
3.6 (V)				19.4K Ω		69K Ω	42K Ω	
3.9 (V)				14k Ω		30.5K Ω	58K Ω	
4.5 (V)				8k Ω		12.1k Ω	180K Ω	
4.9 (V)						7.k6 Ω	850K Ω	
5.0 (V)						6.8k Ω		
5.1 (V)						6.2k Ω		540k Ω
5.5 (V)						4k Ω		71k Ω

Package Style and Pinning (mm)



SMD 10Pin Package

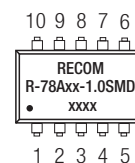
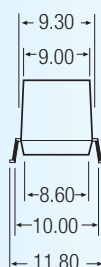
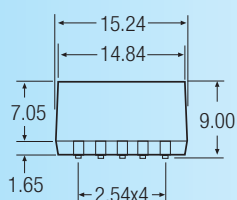

Pin Connections

Pin #	Connection
1,2	+Vin
3,7,8,9	GND
4,5	+Vout
6	V adj
10	Remote On/Off

xx.x \pm 0.5mm
xx.xx \pm 0.25mm

Recommended Footprint Details

