

■ OUTLINE

The R5320G Series are Multi voltage regulator ICs with high output voltage accuracy, extremely low supply current, low noise, low ON-resistance and high ripple rejection by CMOS process. The R5320G Series contain three voltage regulators. Each of these voltage regulators in the R5320G Series consists of a voltage reference unit, an error amplifier, resistors for setting output voltage, a current limit circuit and a chip enable circuit.

The chip enable function contributes to prolong battery life. Further, regulators in the R5320G Series are with low dropout voltage, excellent load transient response and line transient response, thus the R5320G Series are very suitable for the power supply for hand-held communication equipment.

The output voltage of each regulator is fixed with high accuracy by laser trim.

Since the package for these ICs are SSOP8G package, high density mounting of the ICs on boards is possible.

■ FEATURES

- Ultra-Low Supply Current.....TYP. 70 μ A:VR1, TYP. 70 μ A:VR2, TYP. 70 μ A:VR3
- Low Standby CurrentTYP. 0.1 μ A:VR1, TYP. 0.1 μ A:VR2, TYP. 0.1 μ A:VR3
- Low Dropout VoltageTYP. 0.22V (VR1) 0.16V (VR2,VR3)
I_{OUT}=150mA:VR1,80mA:VR2,VR3 (ex. for 3.0V Output Type)
- High Ripple RejectionTYP.70dB (f=1kHz)
- High Output Voltage Accuracy \pm 2.0%
- Excellent Load Transient Response and Line Transient Response
- Small Package8-Pin SSOP (0.65mm pitch)
- Input VoltageMax. 6V

■ APPLICATIONS

- Power source for cellular phones such as GSM,CDMA and Personal Handy-phone System.
- Power source for electrical appliances such as cameras, VCRs, camcorders, etc.
- Power source for battery-powered equipment.

■ BLOCK DIAGRAM

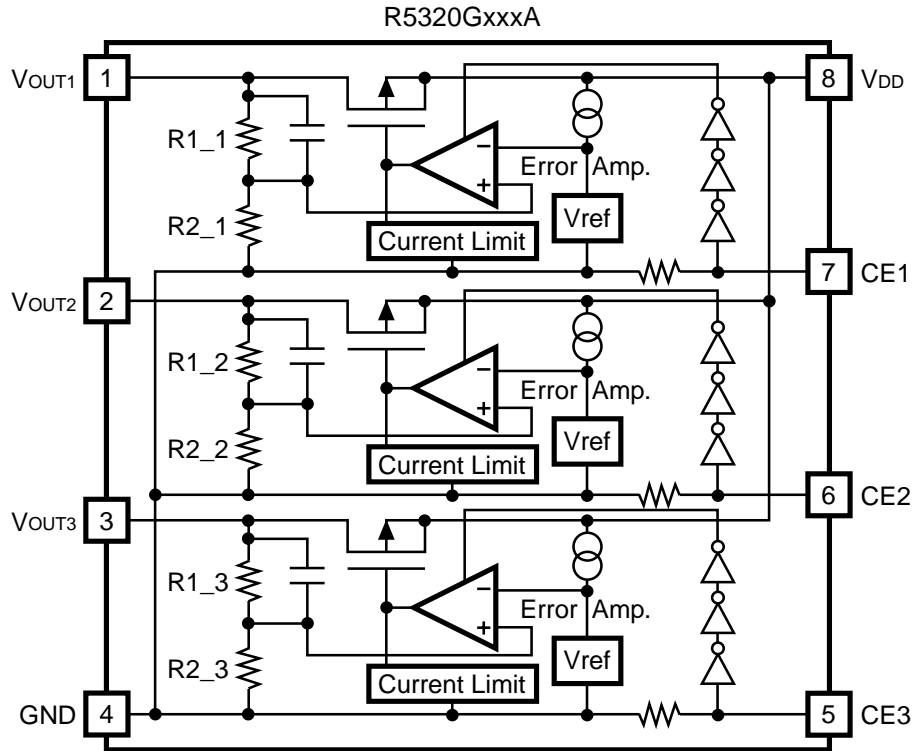

SELECTION GUIDE

The selection can be made by designating the part number as shown below :

R5320G_{xxx}-TR ←Part Number
 ↑↑
 a b

Code	Descriptions
a	Serial Number for Voltage setting from 001
b	Alphabetical Code for Mask Versions A: Standard

PIN CONFIGURATION

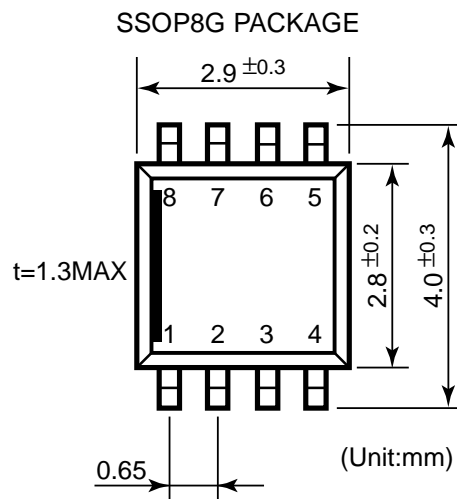

PIN DESCRIPTIONS

Pin NO.	Symbol	Descriptions
1	V _{OUT1}	Output Pin
2	V _{OUT2}	Output Pin
3	V _{OUT3}	Output Pin
4	GND	Ground Pin
5	CE3	Chip Enable Pin
6	CE2	Chip Enable Pin
7	CE1	Chip Enable Pin
8	V _{DD}	Input Pin

■ ABSOLUTE MAXIMUM RATINGS

Symbol	Item	Rating	Unit
V _{IN}	Input Voltage	7	V
CE	Input Voltage (CE Pin)	-0.3 ~ V _{IN} +0.3	V
V _{OUT}	Output Voltage	-0.3 ~ V _{IN} +0.3	V
I _{OUT1}	Output Current (V _{OUT1})	200	mA
I _{OUT2}	Output Current (V _{OUT2})	100	mA
I _{OUT3}	Output Current (V _{OUT3})	100	mA
PD	Power Dissipation	300	mW
T _{opt}	Operating Temperature Range	-40 ~ 85	°C
T _{stg}	Storage Temperature Range	-55 ~ 125	°C

■ ELECTRICAL CHARACTERISTICS

● R5320GxxxA

VR1

T_{opt}=25°C

Symbol	Item	Conditions	MIN.	TYP.	MAX.	Unit
V _{OUT}	Output Voltage	V _{IN} -V _{OUT} =1.0V 1mA≤I _{OUT} ≤30mA	×0.98		×1.02	V
I _{OUT}	Output Current	V _{IN} -V _{OUT} =1.0V	150			mA
ΔV _{OUT} /ΔI _{OUT}	Load Regulation	V _{IN} -V _{OUT} =1.0V 1mA≤I _{OUT} ≤80mA		12	40	mV
V _{DIF}	Dropout Voltage	Refer to Electrical Characteristic by Output Voltage (VR1)				
I _{SS}	Supply Current	V _{IN} -V _{OUT} =1.0V		70	120	μA
I _{standby}	Supply Current (Standby)	V _{IN} -V _{OUT} =1.0V V _{CE} =GND		0.1	1.0	μA
ΔV _{OUT} /ΔV _{IN}	Line Regulation	V _{OUT} +0.5V≤V _{IN} ≤6V I _{OUT} =30mA		0.05	0.20	%/V
RR	Ripple Rejection	f=1kHz, sinusoidal 1Vp-p V _{IN} -V _{OUT} =1.0V		70		dB
V _{IN}	Input Voltage				6	V
ΔV _{OUT} /ΔT	Output Voltage Temperature Coefficient	I _{OUT} =50mA -40°C≤T _{opt} ≤85°C		±100		ppm/°C
I _{LIM}	Short Current Limit	V _{OUT} =0V		50		mA
R _{DN}	CE Pull-down Resistance		2.5	5	10	MΩ
V _{CEH}	CE Input Voltage "H"		1.5		V _{IN}	V
V _{CEL}	CE Input Voltage "L"		0		0.25	V
en	Output Noise	BW=10Hz-100kHz		60		μV _{rms}

● ELECTRICAL CHARACTERISTICS by OUTPUT VOLTAGE(VR1)

T_{opt}=25°C

Output Voltage V _{OUT} (V)	Dropout Voltage		
	V _{DIF} (V)		
	Conditions	TYP.	MAX.
2.0≤V _{OUT} ≤2.4	I _{OUT} =150mA	0.35	0.55
2.5≤V _{OUT} ≤2.7		0.3	0.45
2.8≤V _{OUT} ≤3.3		0.22	0.35
3.4≤V _{OUT} ≤5.0		0.2	0.3

VR2

T_{opt}=25°C

Symbol	Item	Conditions	MIN.	TYP.	MAX.	Unit
V _{OUT}	Output Voltage	V _{IN} -V _{OUT} =1.0V 1mA≤I _{OUT} ≤30mA	×0.98		×1.02	V
I _{OUT}	Output Current	V _{IN} -V _{OUT} =1.0V	80			mA
ΔV _{OUT} /ΔI _{OUT}	Load Regulation	V _{IN} -V _{OUT} =1.0V 1mA≤I _{OUT} ≤50mA		12	40	mV
V _{DIF}	Dropout Voltage	Refer to Electrical Characteristics by Output Voltage (VR2)				
I _{SS}	Supply Current	V _{IN} -V _{OUT} =1.0V		70	120	μA
I _{standby}	Supply Current (Standby)	V _{IN} -V _{OUT} =1.0V V _{CE} =GND		0.1	1.0	μA
ΔV _{OUT} /ΔV _{IN}	Line Regulation	V _{OUT} +0.5V≤V _{IN} ≤6V I _S ≤30mA		0.05	0.20	V
RR	Ripple Rejection	f=1kHz, sinusoidal 1Vp-p V _{IN} -V _{OUT} =1.0V		70		DB
V _{IN}	Input Voltage				6	V
ΔV _{OUT} /ΔT	Output Voltage Temperature Coefficient	I _{OUT} =30mA -40°C≤T _{opt} ≤85°C		±100		ppm/ °C
I _{LIM}	Short Current Limit	V _{OUT} =0V		50		mA
R _{DN}	CE Pull-down Resistance		2.5	5	10	MΩ
V _{CEH}	CE Input Voltage "H"		1.5		V _{IN}	V
V _{CEL}	CE Input Voltage "L"		0		0.25	V
en	Output Noise	BW=10Hz-100KHz		60		μVrms

● ELECTRICAL CHARACTERISTICS by OUTPUT VOLTAGE (VR2)

T_{opt}=25°C

Output Voltage V _{OUT} (V)	Dropout Voltage V _{DIF} (V)		
	Conditions	TYP.	MAX.
2.0≤V _{OUT} ≤2.4	I _{OUT} =80mA	0.22	0.38
2.5≤V _{OUT} ≤2.7		0.2	0.38
2.8≤V _{OUT} ≤3.3		0.16	0.24
3.4≤V _{OUT} ≤5.0		0.12	0.24

VR3

Topt=25°C

Symbol	Item	Conditions	MIN.	TYP.	MAX.	Unit
V _{OUT}	Output Voltage	V _{IN} -V _{OUT} =1.0V 1mA ≤ I _{OUT} ≤ 30mA	×0.98		×1.02	V
I _{OUT}	Output Current	V _{IN} -V _{OUT} =1.0V	80			mA
ΔV _{OUT} /ΔI _{OUT}	Load Regulation	V _{IN} -V _{OUT} =1.0V 1mA ≤ I _{OUT} ≤ 50mA		12	40	mV
V _{DIF}	Dropout Voltage	Refer to Electrical Characteristics by Dropout Voltage (VR3)				
I _{SS}	Supply Current	V _{OUT} +0.5V ≤ V _{IN} ≤ 6V I _{OUT} =30mA		70	120	μA
I _{standby}	Supply Current (Standby)	f=1kHz, sinusoidal 1Vp-p V _{IN} -V _{OUT} =1.0V		0.1	1.0	μA
ΔV _{OUT} /ΔV _{IN}	Line Regulation			0.05	0.20	%/V
RR	Ripple Rejection	I _{OUT} =30mA -40°C ≤ Topt ≤ 85°C		70		dB
V _{IN}	Input Voltage	V _{OUT} =0V			6	V
ΔV _{OUT} /ΔT	Output Voltage Temperature Coefficient			±100		ppm/°C
I _{LIM}	Short Current Limit	BW=10Hz-100KHz		50		mA
R _{DN}	CE Pull-down Resistance		2.5	5	10	MΩ
V _{CEH}	CE Input Voltage "H"		1.5		V _{IN}	V
V _{CEL}	CE Input Voltage "L"		0		0.25	V
en	Output Noise			60		μVrms

● ELECTRICAL CHARACTERISTICS by OUTPUT VOLTAGE (VR3)

Topt=25°C

Output Voltage V _{OUT} (V)	Dropout Voltage V _{DIF} (V)		
	Conditions	TYP.	MAX.
2.0 ≤ V _{OUT} ≤ 2.4	I _{OUT} =80mA	0.24	0.38
2.5 ≤ V _{OUT} ≤ 2.7		0.22	0.28
2.8 ≤ V _{OUT} ≤ 3.3		0.16	0.24
3.4 ≤ V _{OUT} ≤ 5.0		0.15	0.24

■ OPERATION

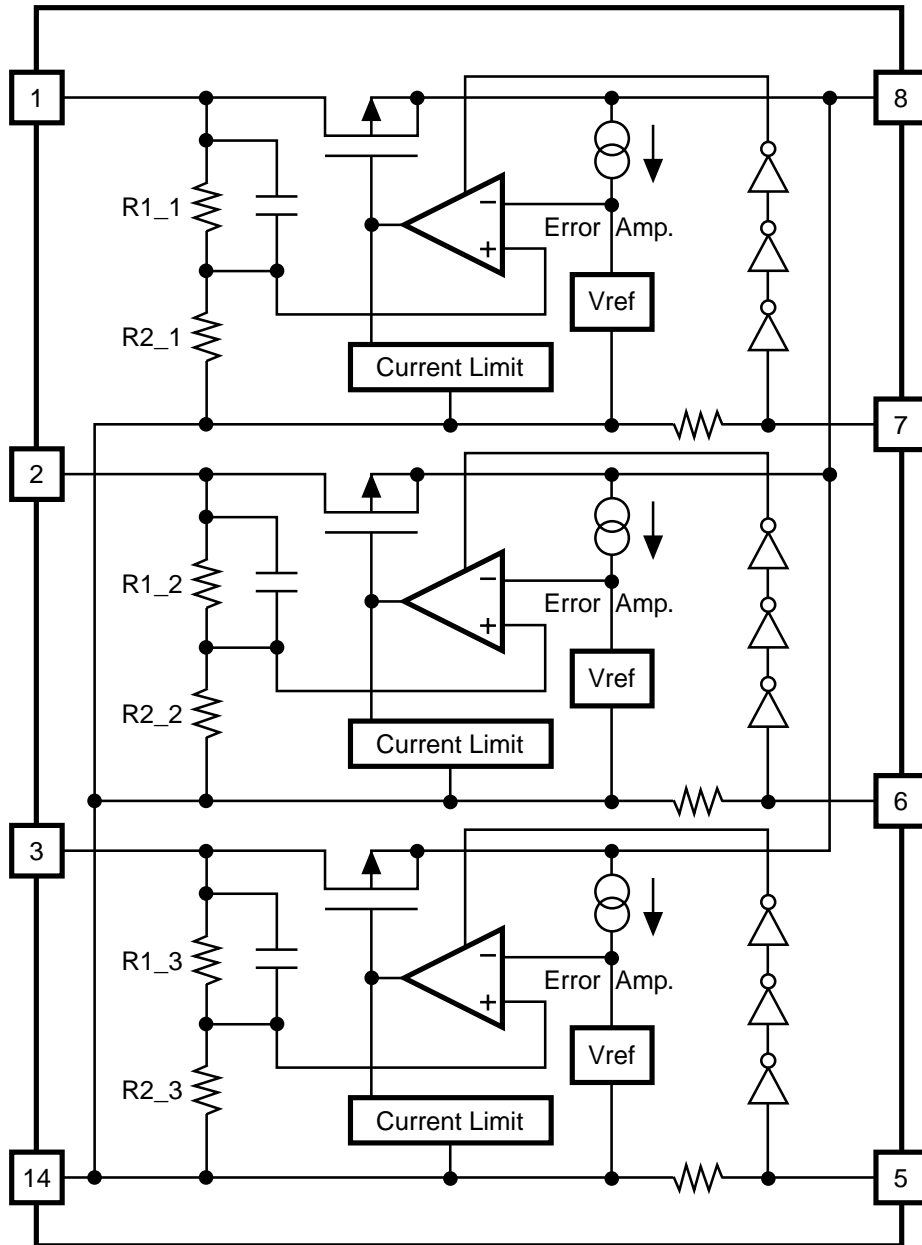

Fluctuation of each regulator's output voltage, or $V_{OUT1, 2, 3}$ is detected individually and put back to an error amplifier through feedback resistors, or $R1_1, R2_1, R1_2, R2_2, R1_3, R2_3$ and compared with a reference voltage and compensated for the result and make a constant voltage.

In each regulator, short protection is made by a current limit circuit and stand-by mode is available by a chip enable circuit.

TEST CIRCUITS

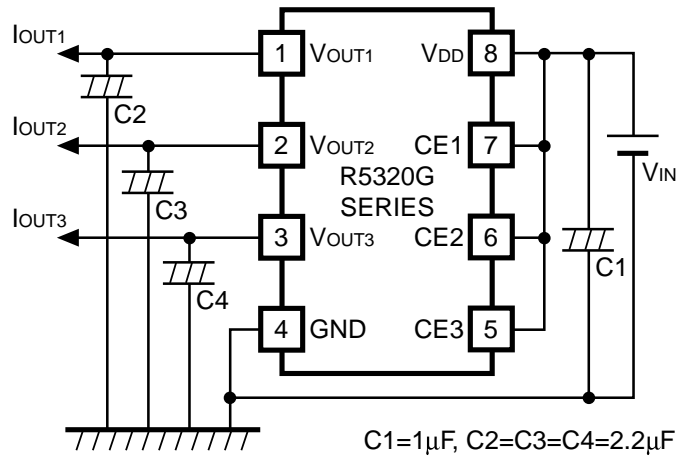

Basic Test Circuit

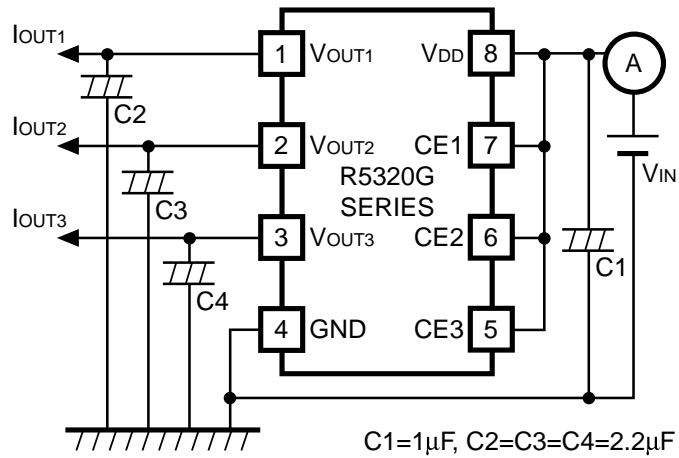

Test Circuit for Supply Current

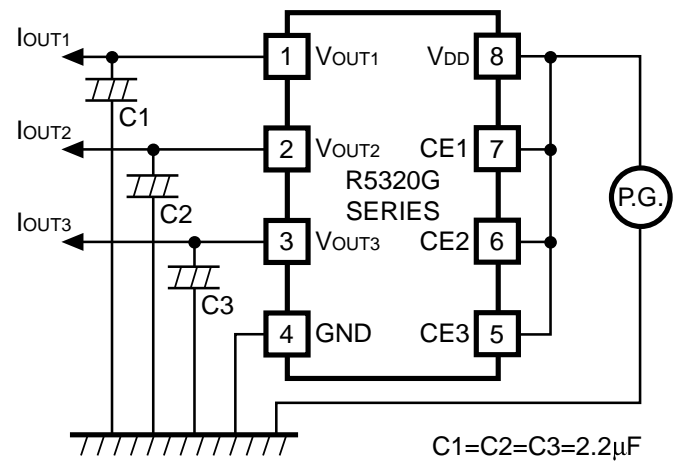

Test Circuit for Line Transient Response

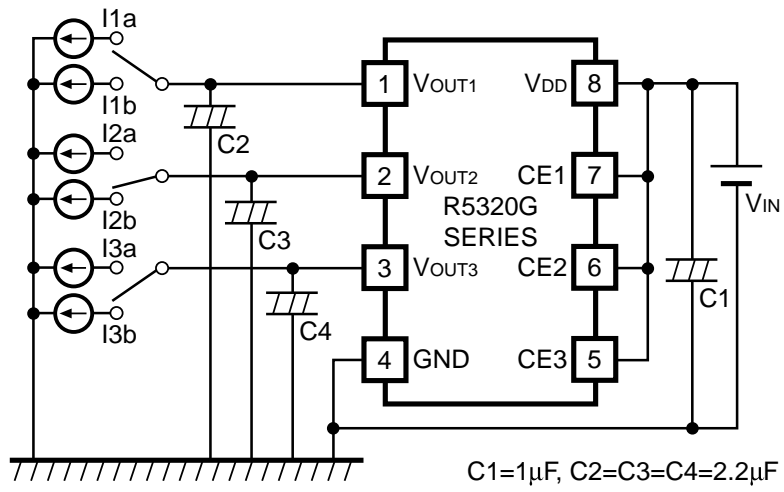

Test Circuit for Load Transient Response

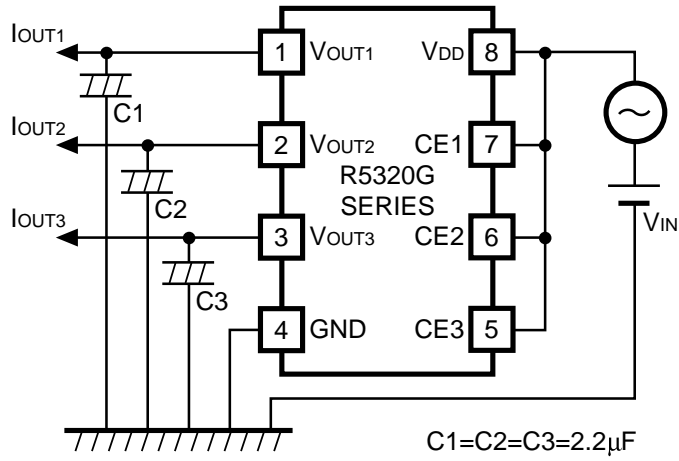

Test Circuit for Ripple Rejection

■ TYPICAL CHARACTERISTICS

1) Output Voltage vs. Output Current

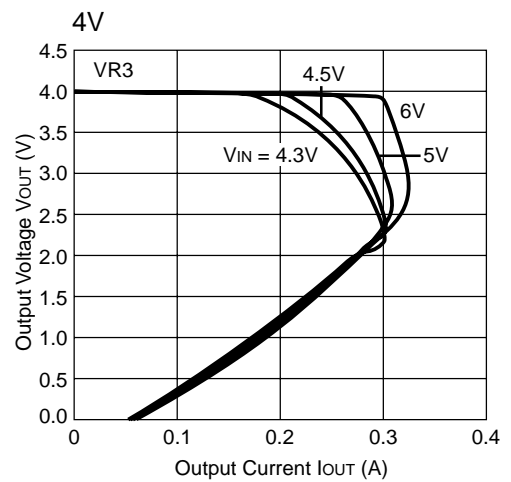
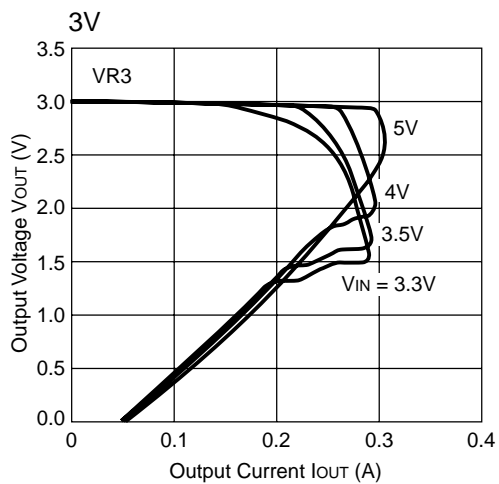
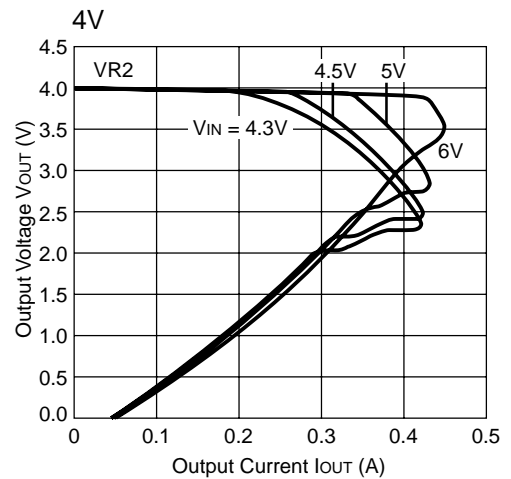
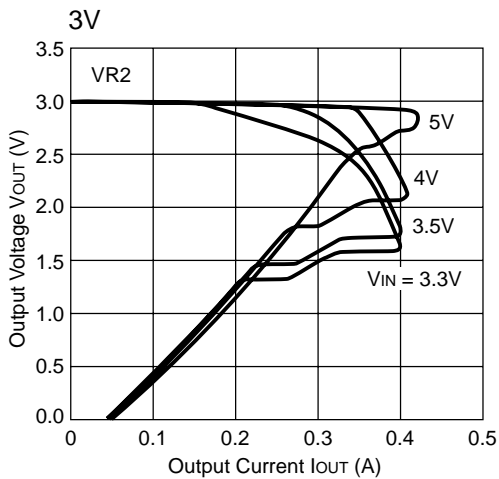
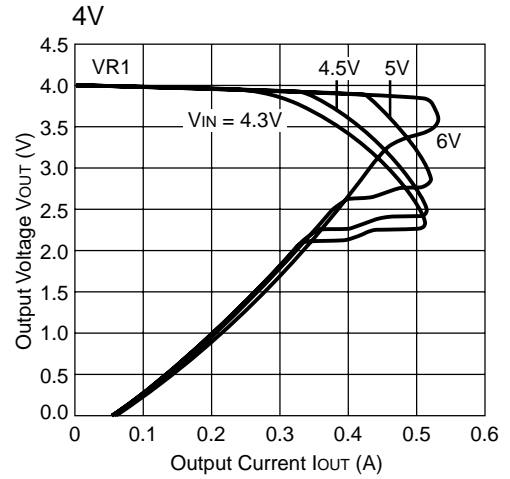
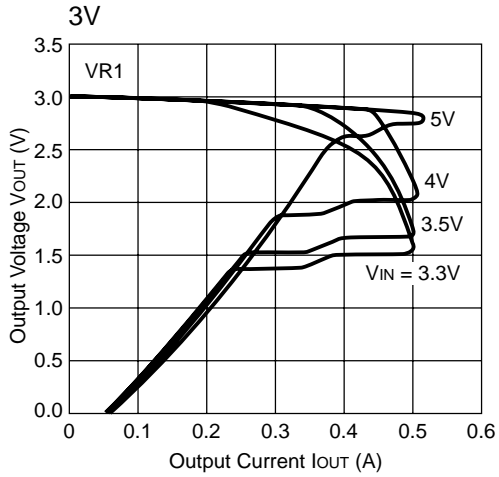

2) Output Voltage vs. Input Voltage

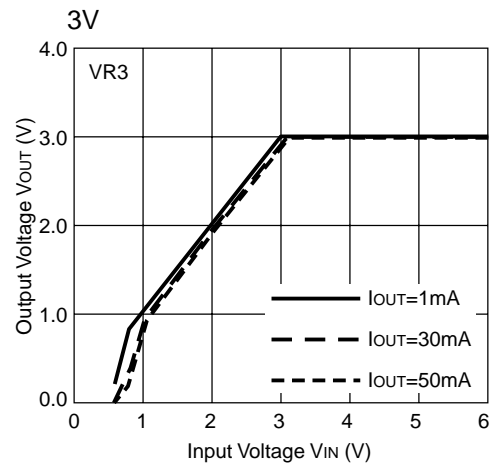
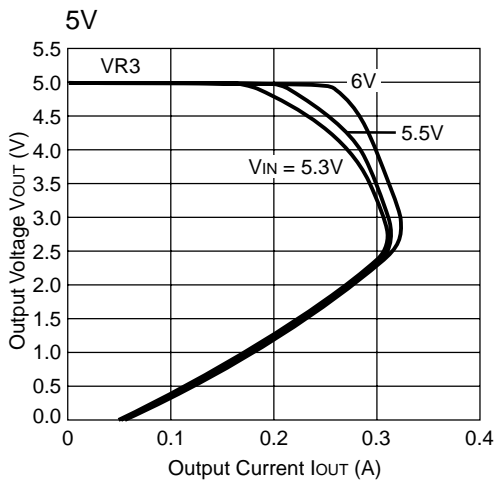
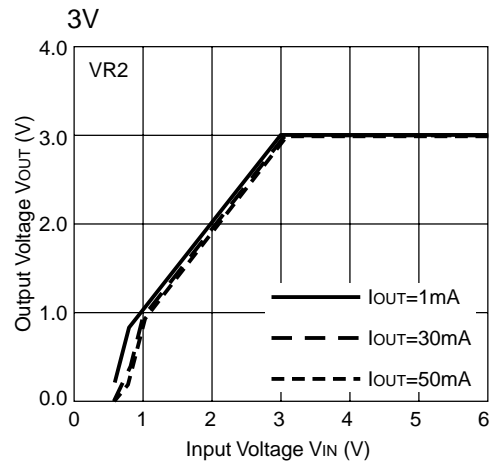
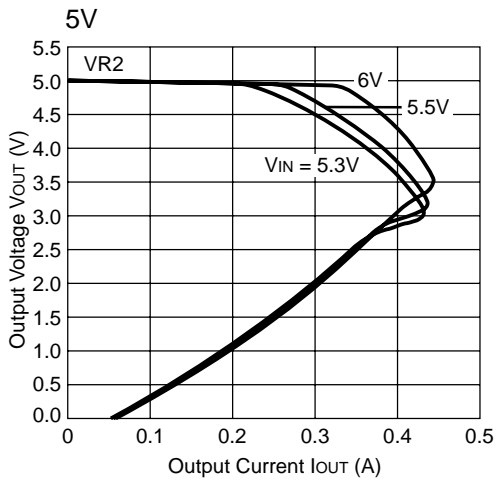
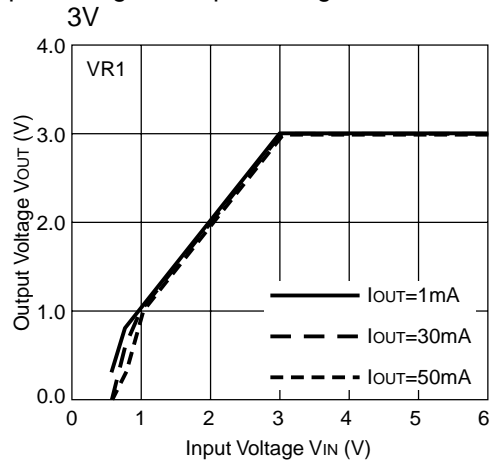
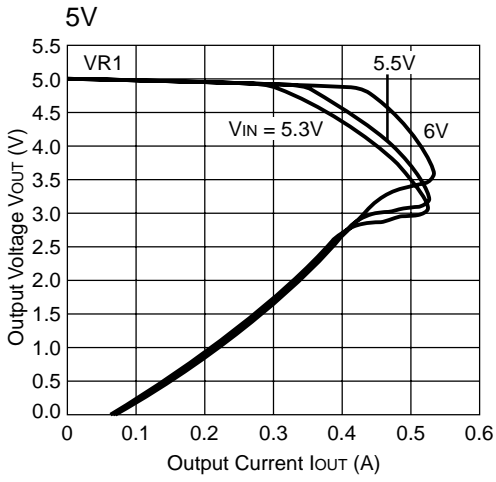

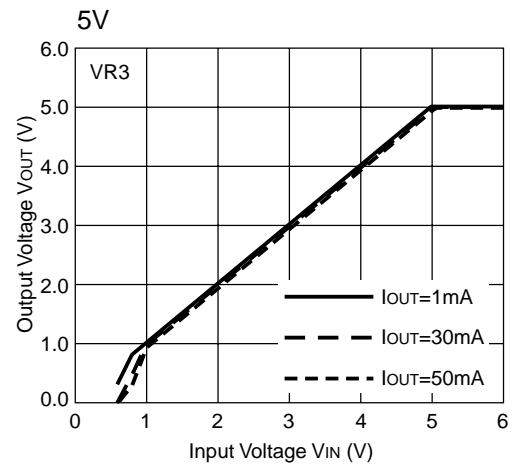
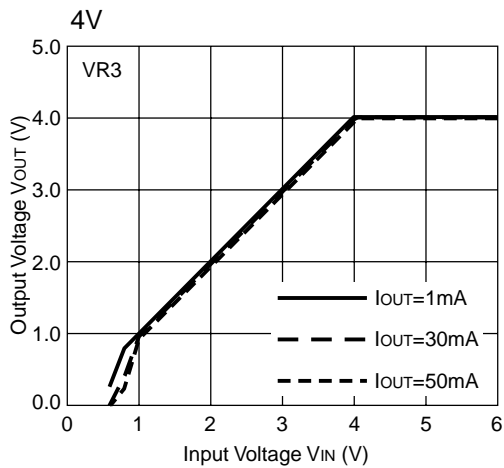
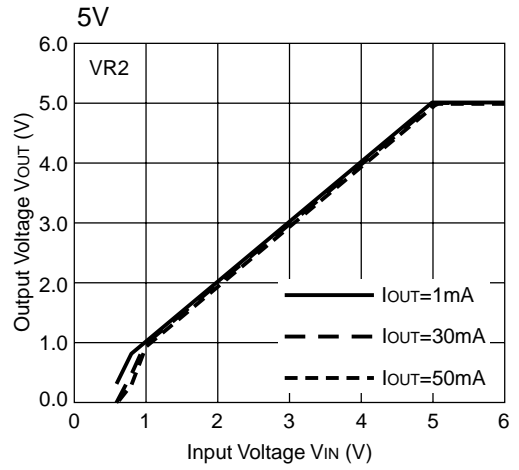
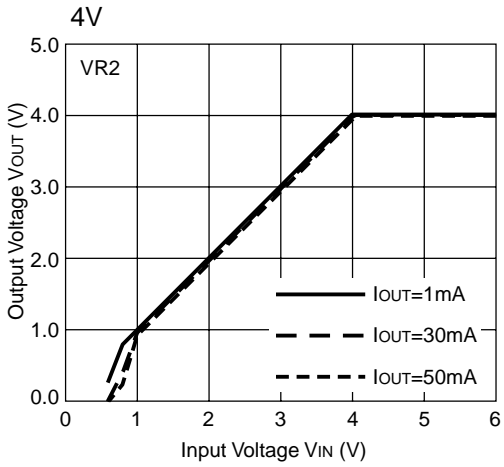
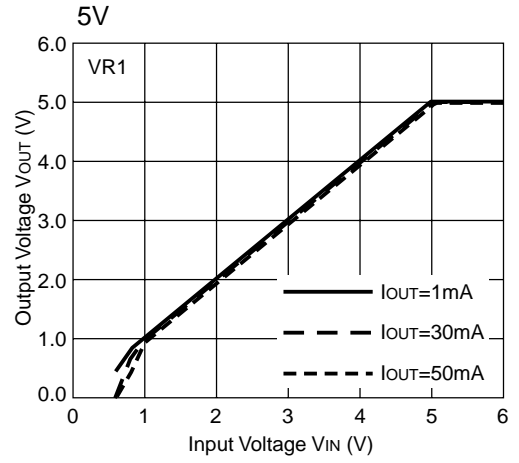
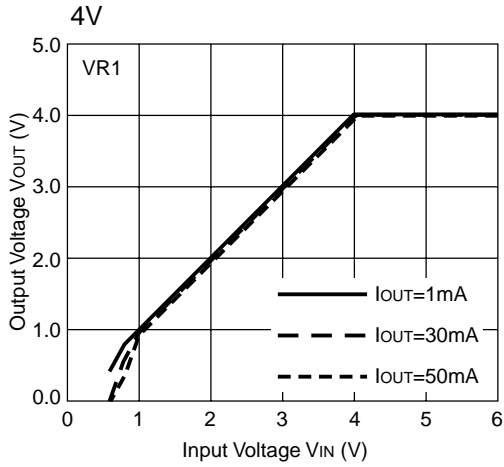

3) Ripple Rejection vs. Input Voltage (DC Bias)
3V

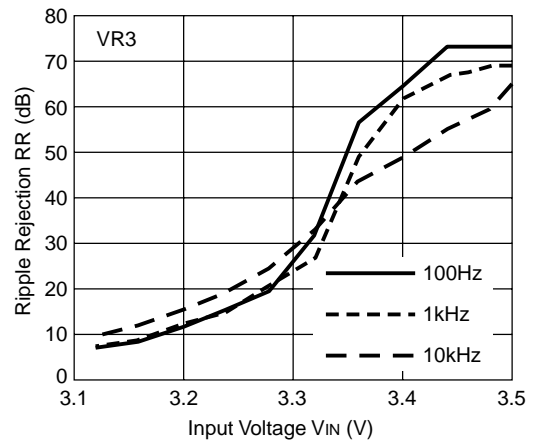
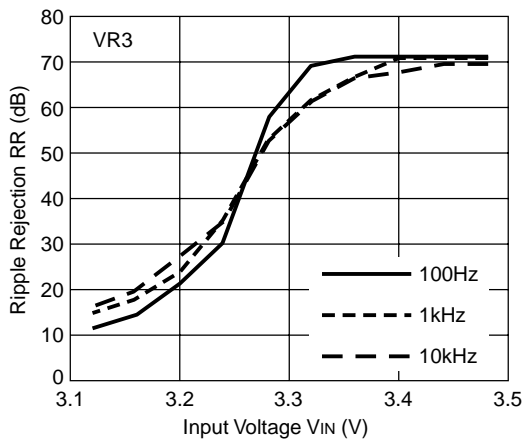
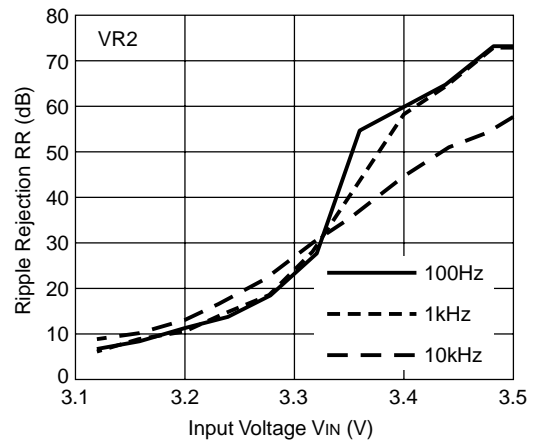
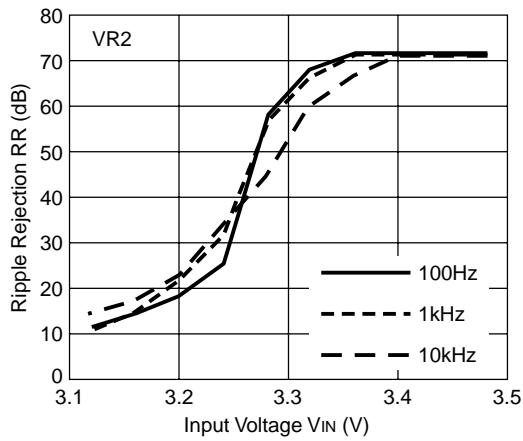
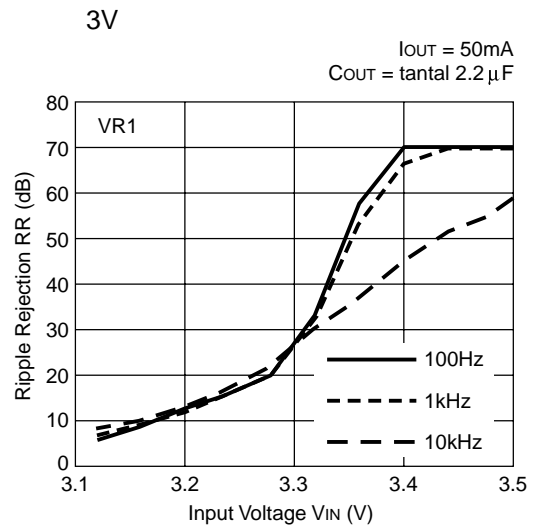
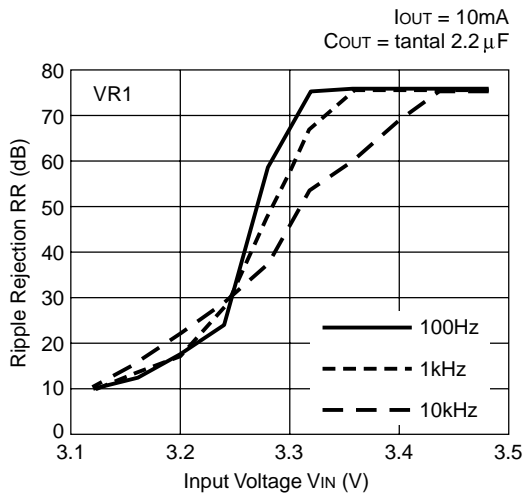

4) Output Voltage vs. Temperature

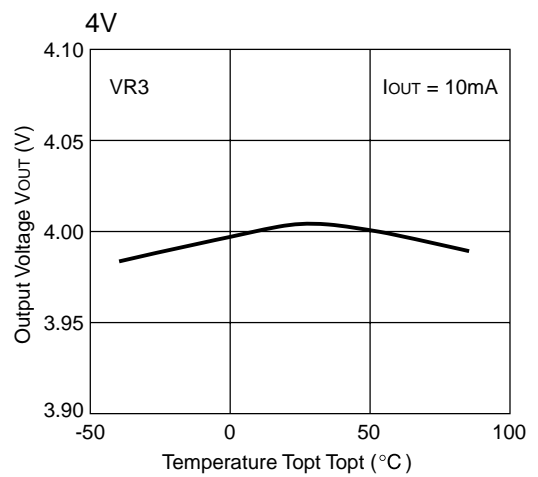
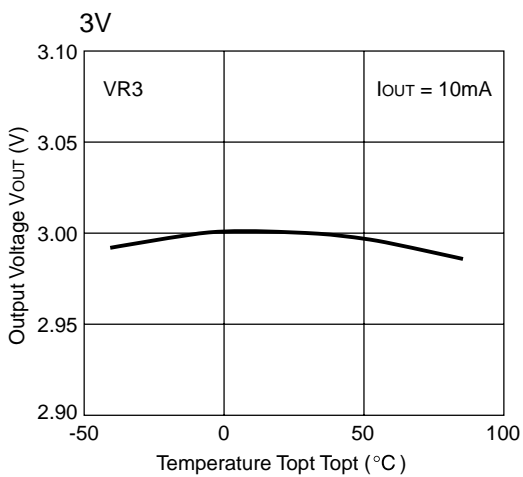
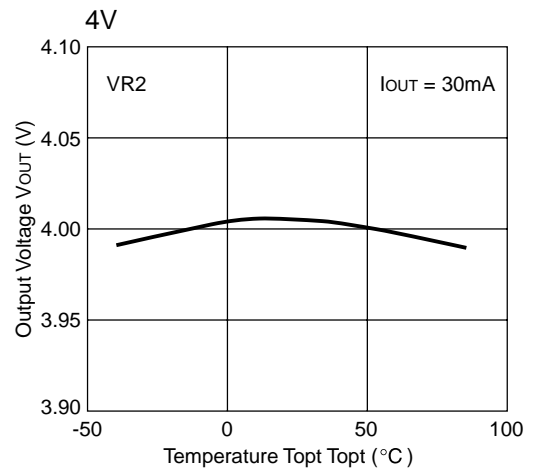
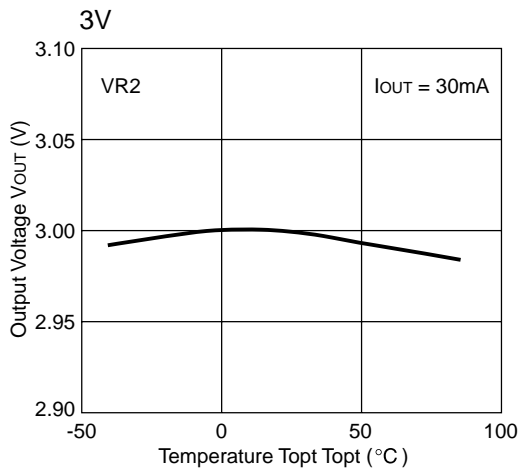
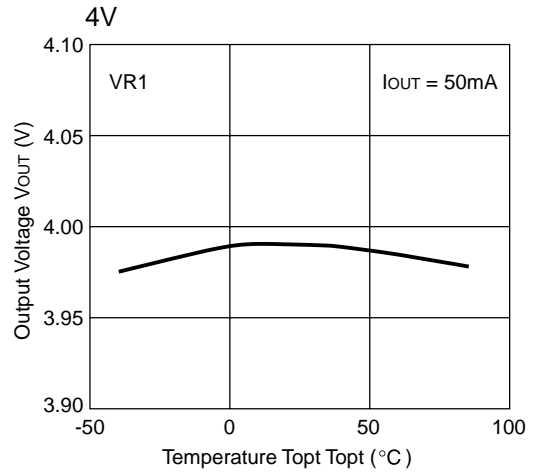
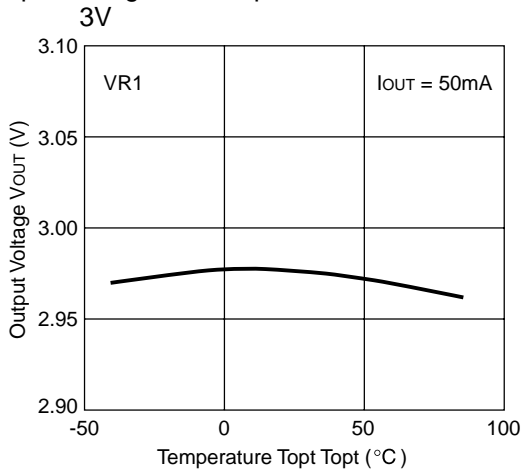

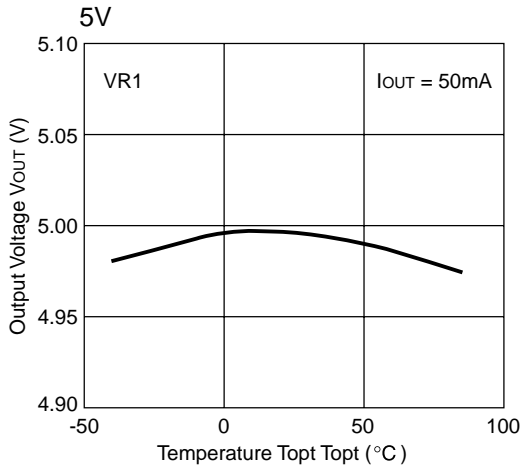

5) Supply Current vs. Input Voltage

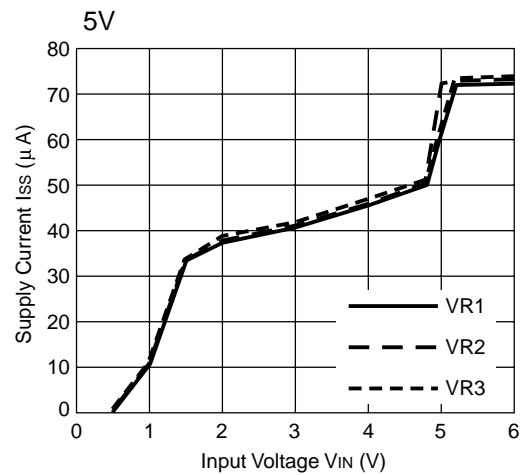
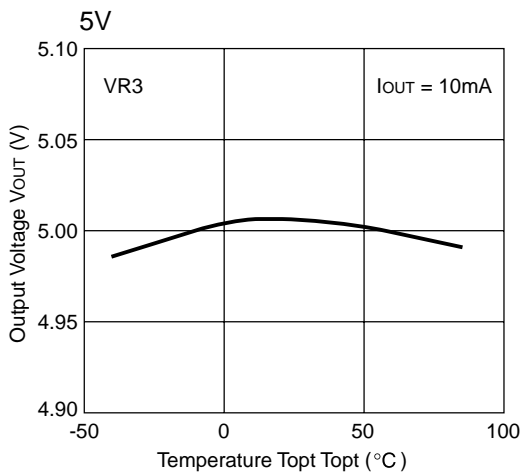
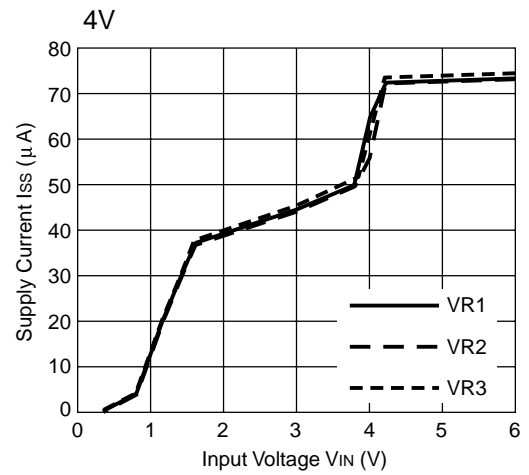
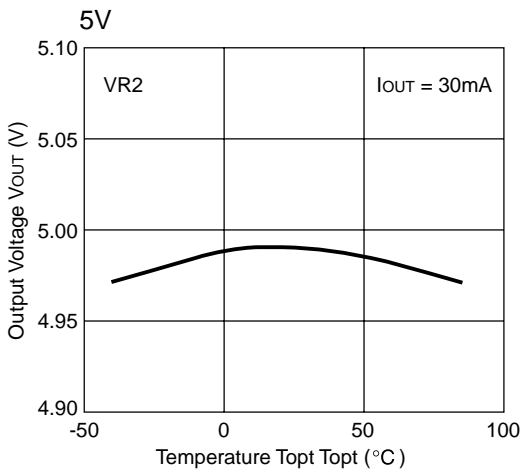
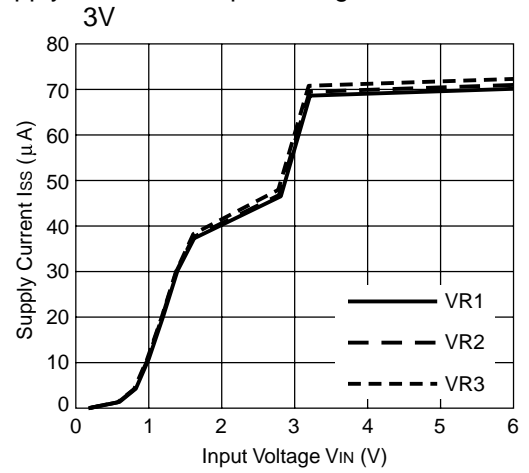

6) Supply Current vs. Temperature

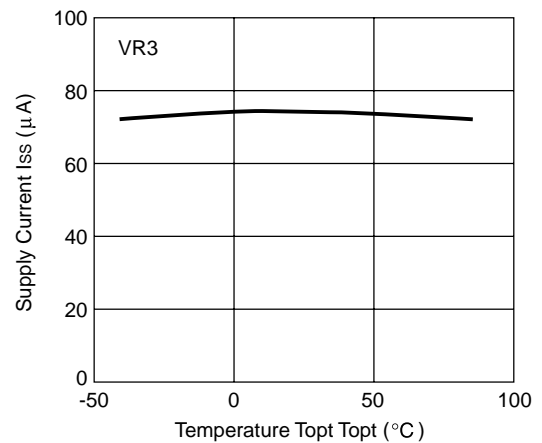
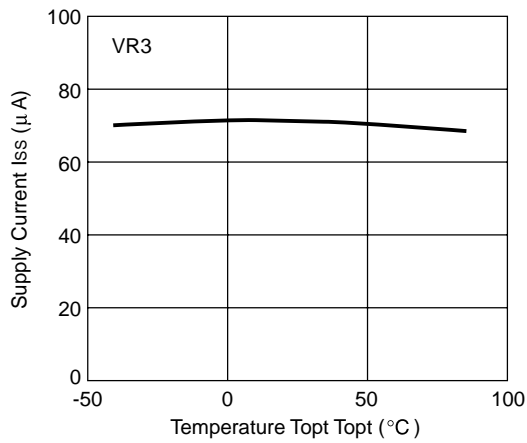
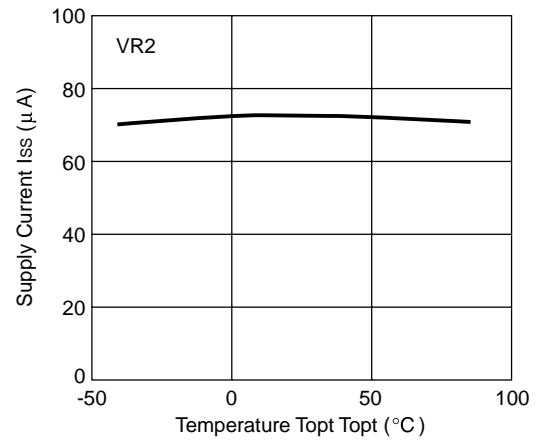
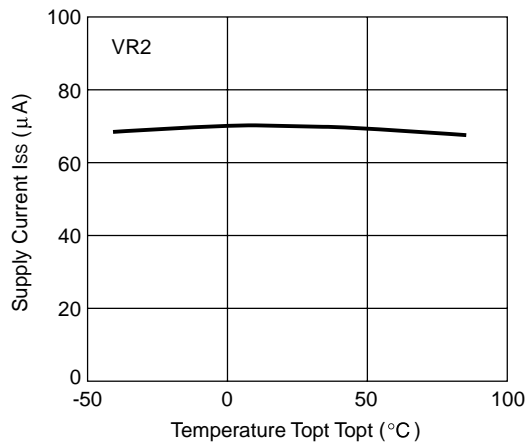
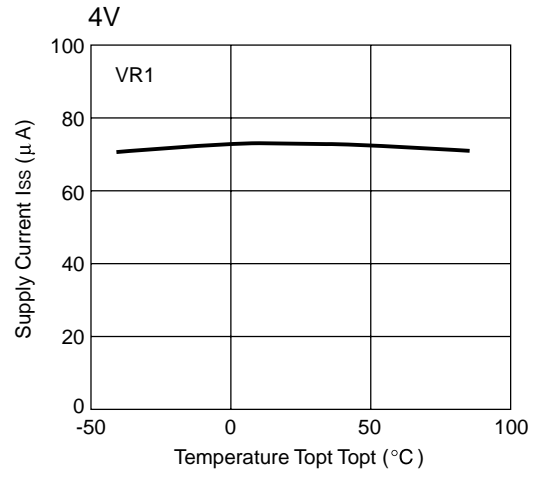
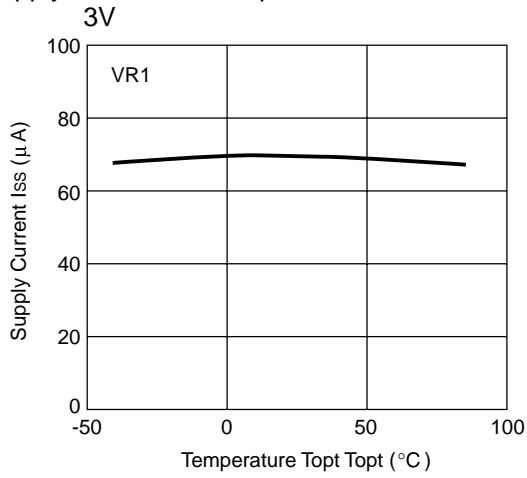

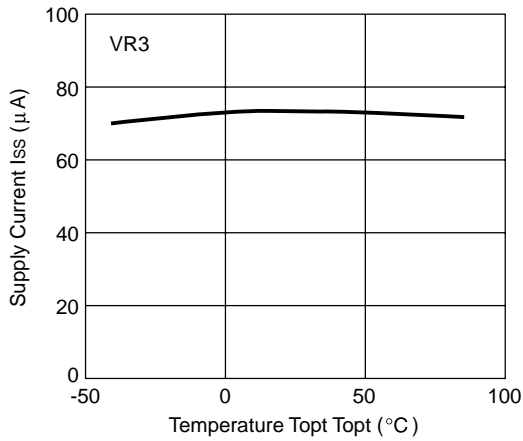
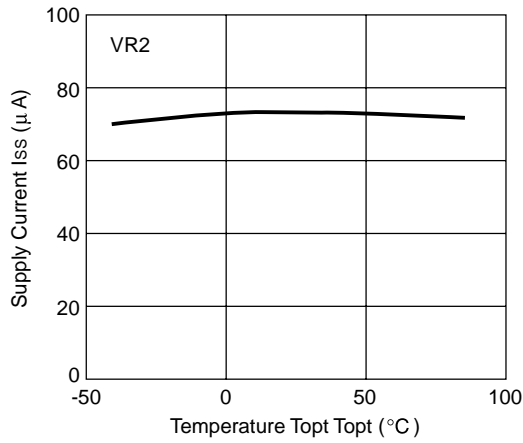
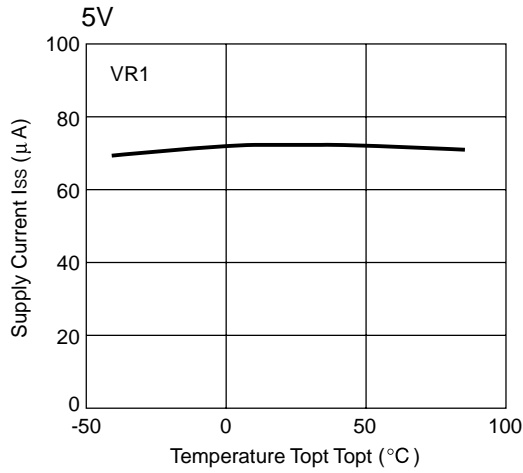

7) Dropout Voltage vs. Set Output Voltage

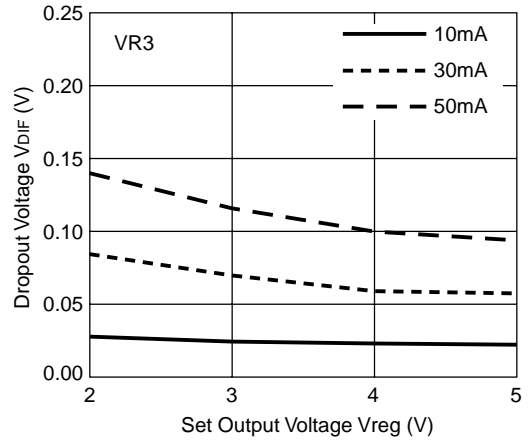
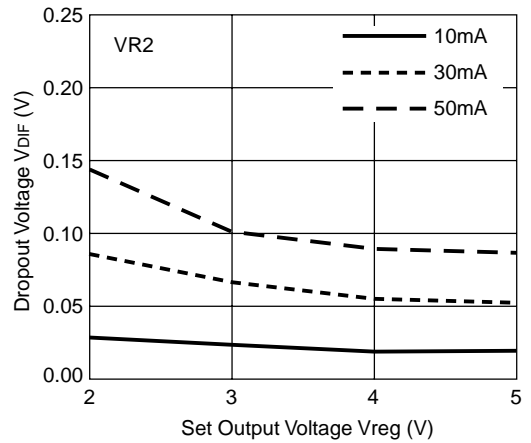
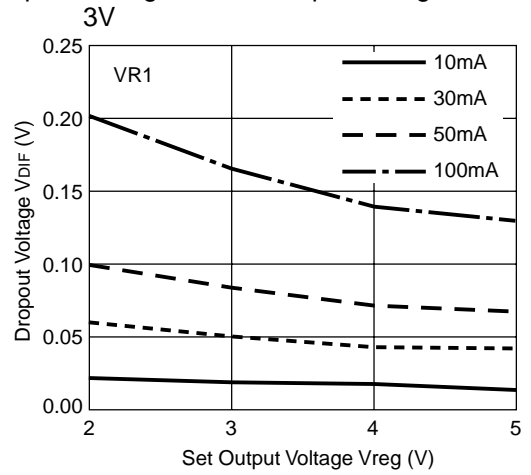

8) Ripple Rejection vs. Frequency

3V

$C_{OUT} = 0.47\mu F$

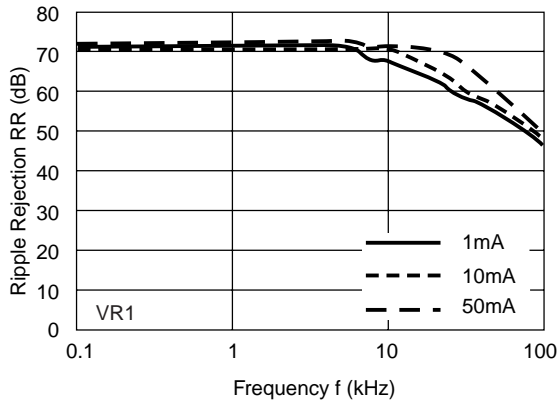

3V

$C_{OUT} = 2.2\mu F$

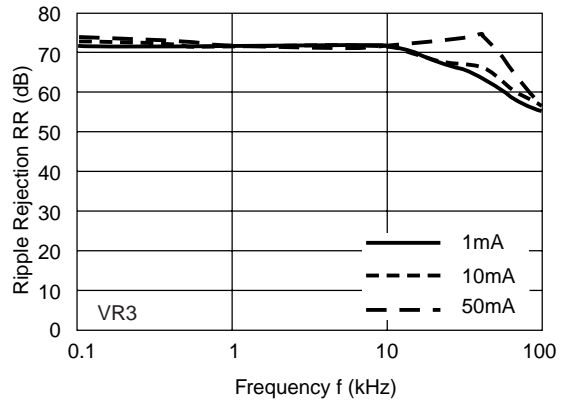
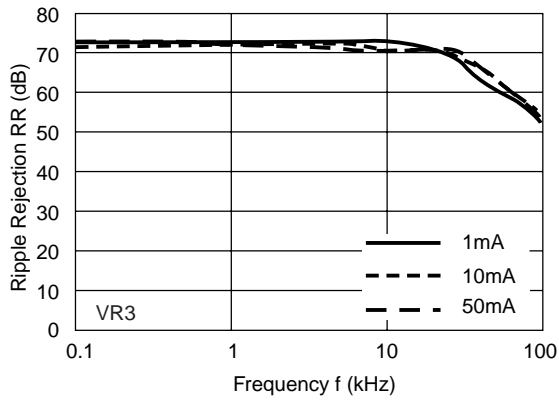
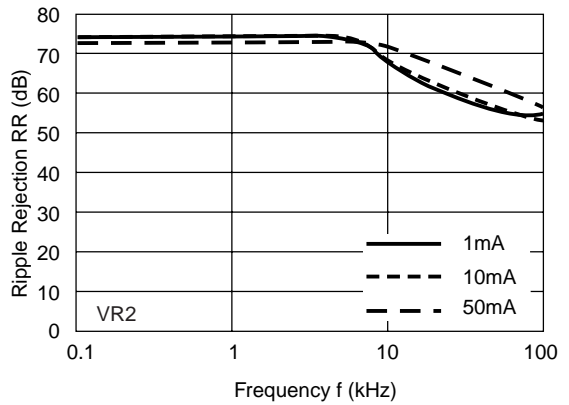
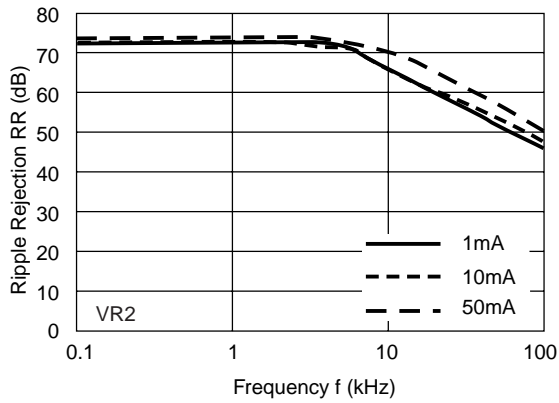
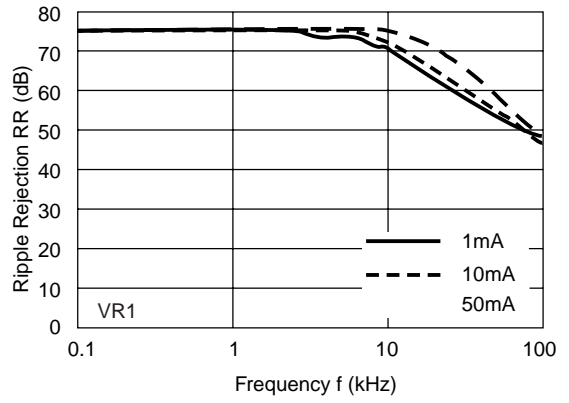

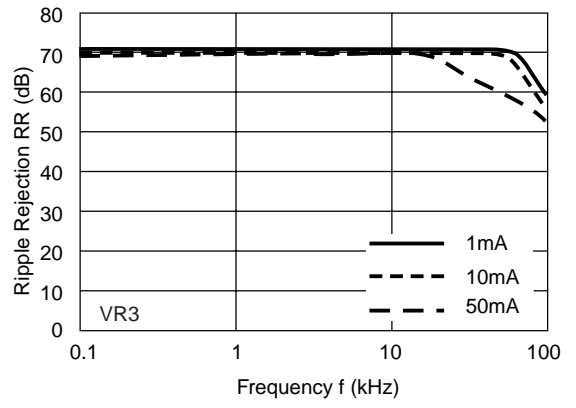
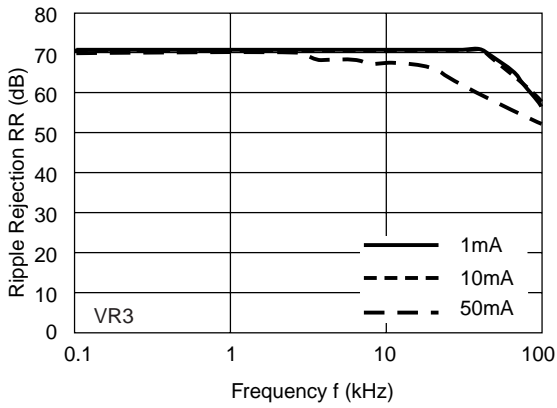
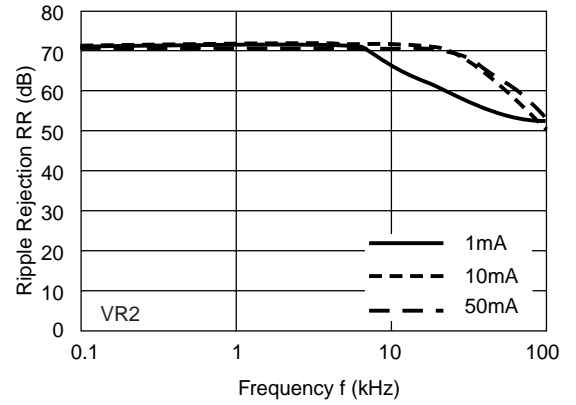
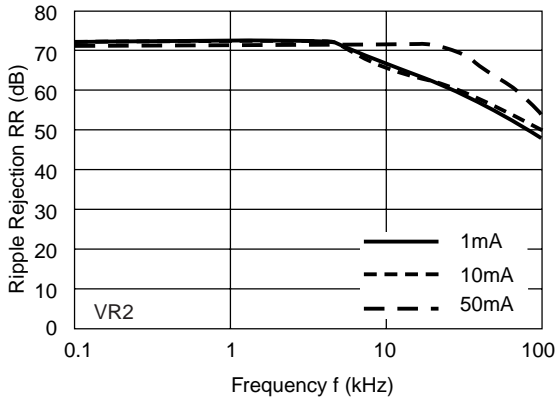
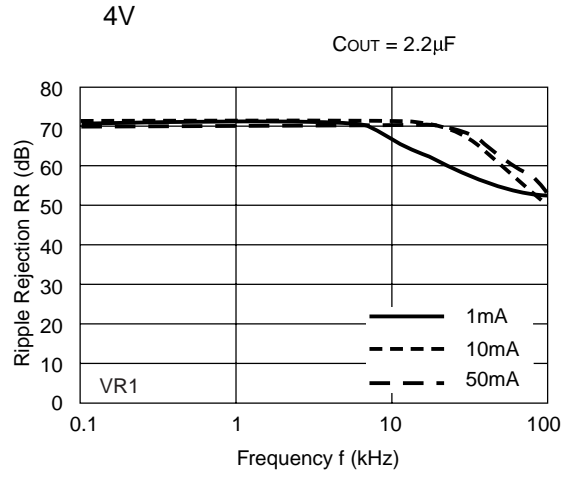
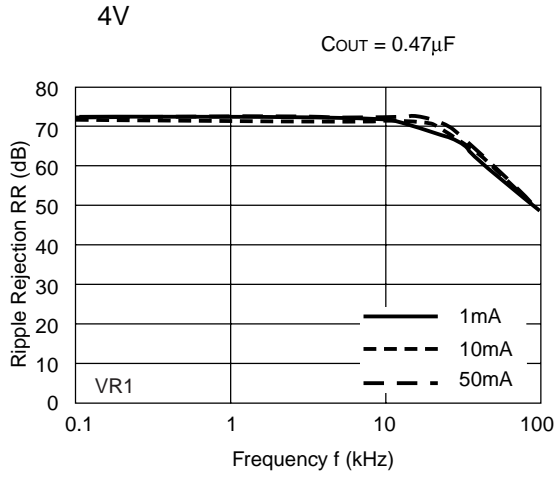

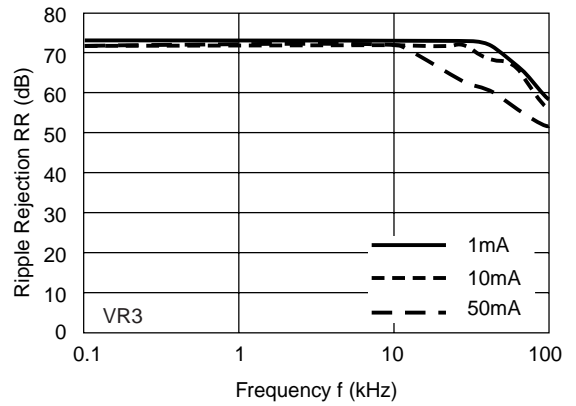
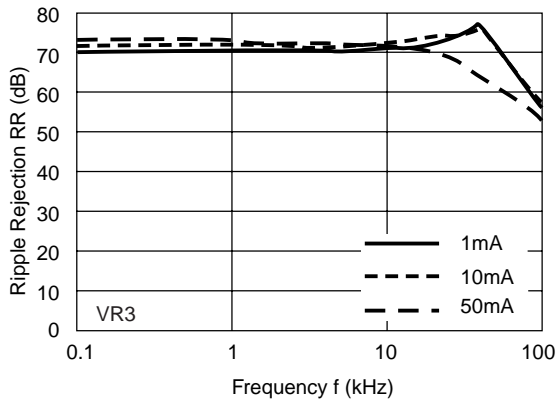
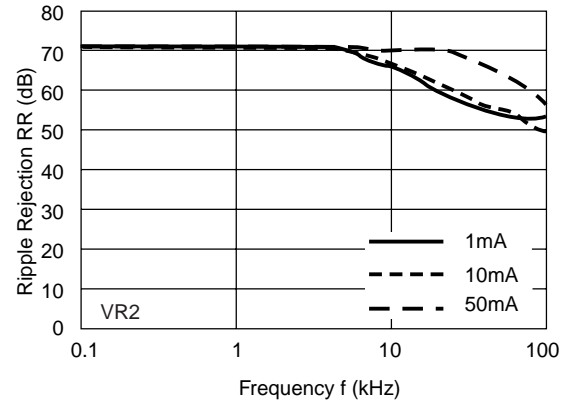
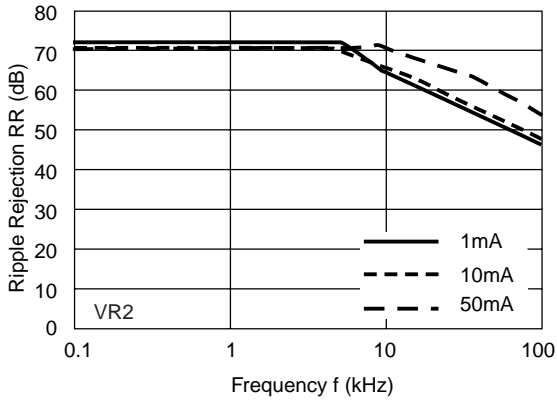
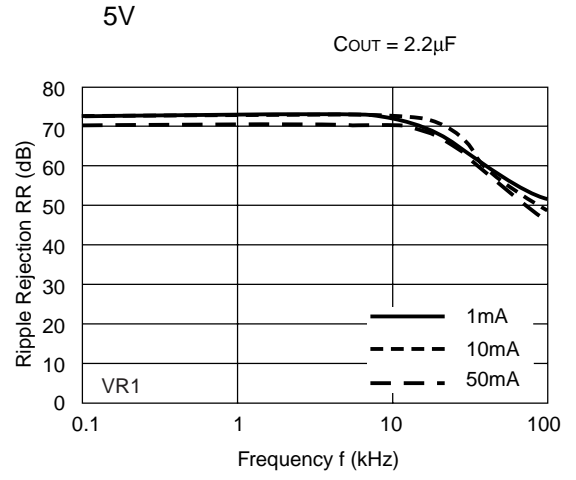
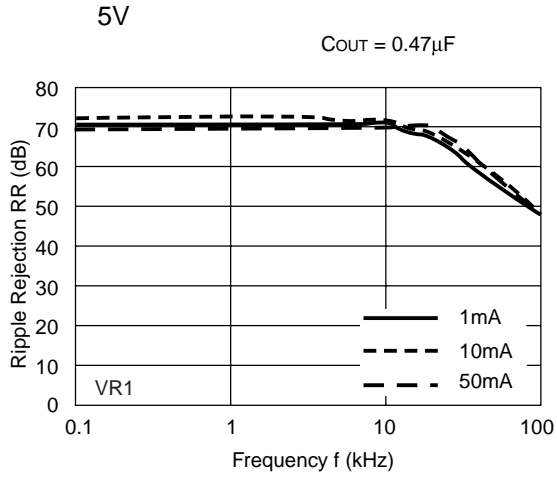

9) Dropout Voltage vs. Output Current

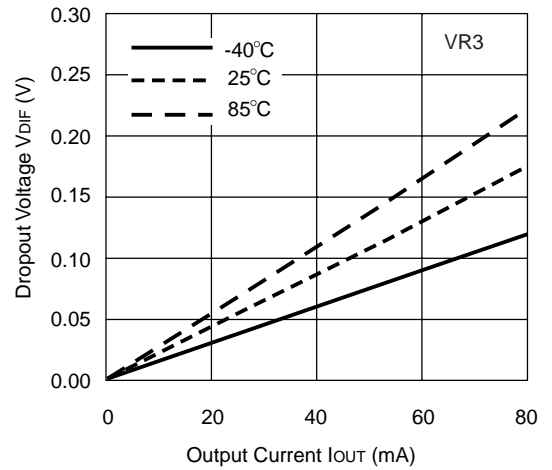
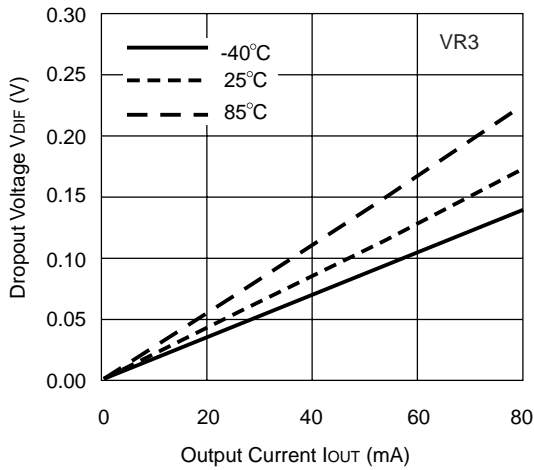
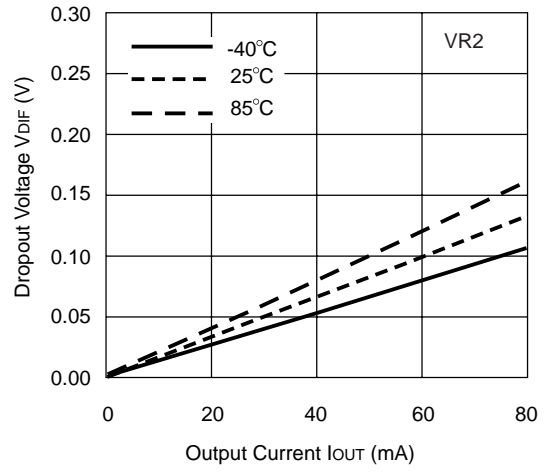
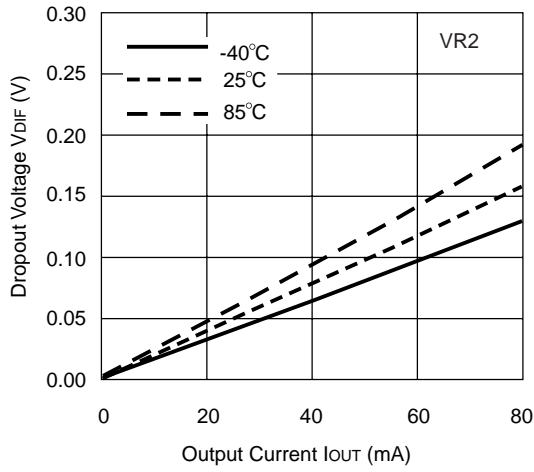
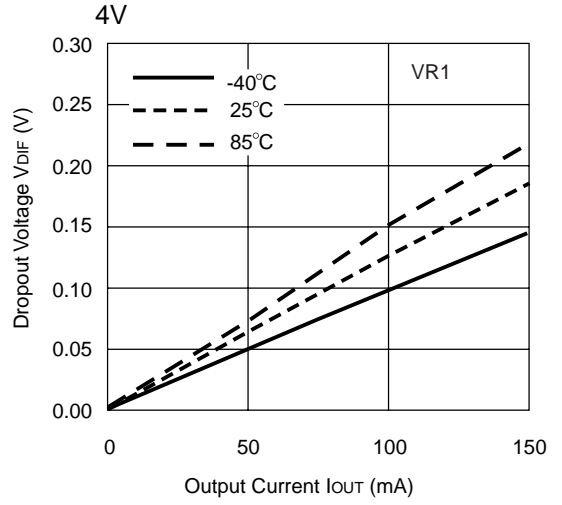
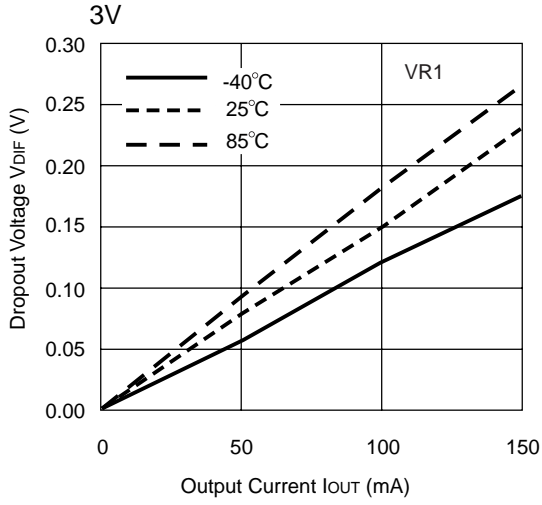

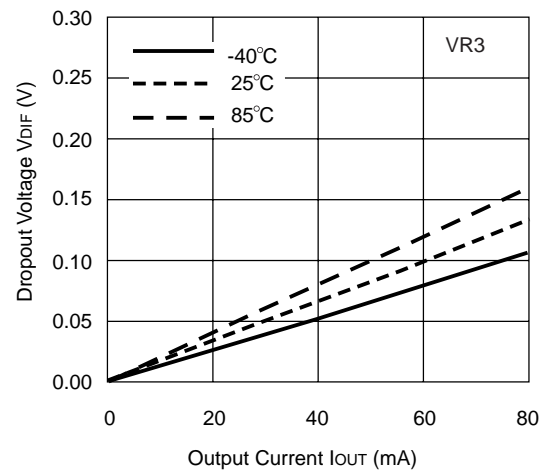
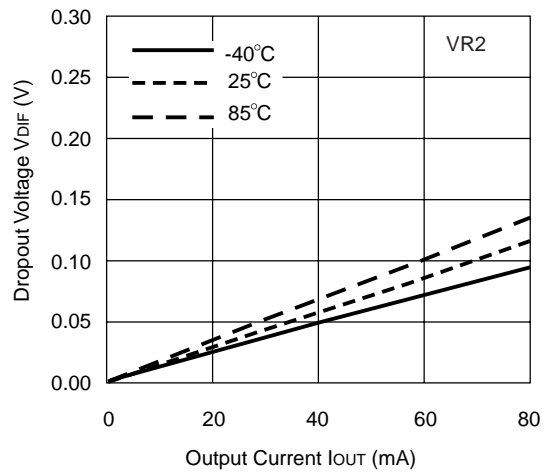
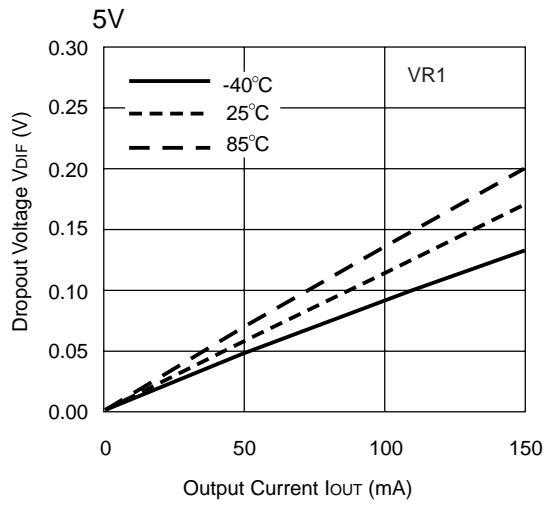

10) Line Transient Response

$T_r=T_f=5\mu s$
 $C_{OUT}=\text{Tantal } 2.2\mu F$

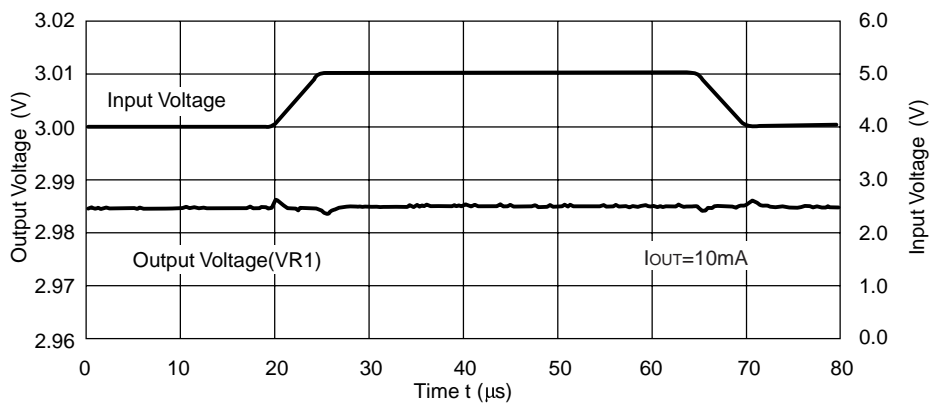
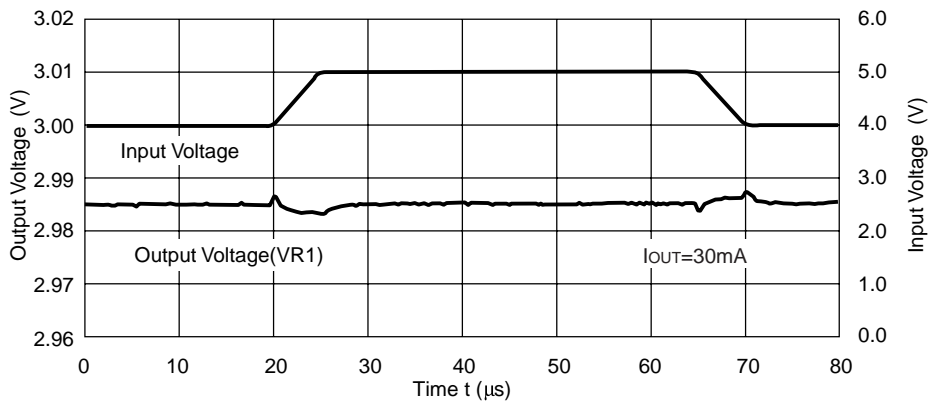
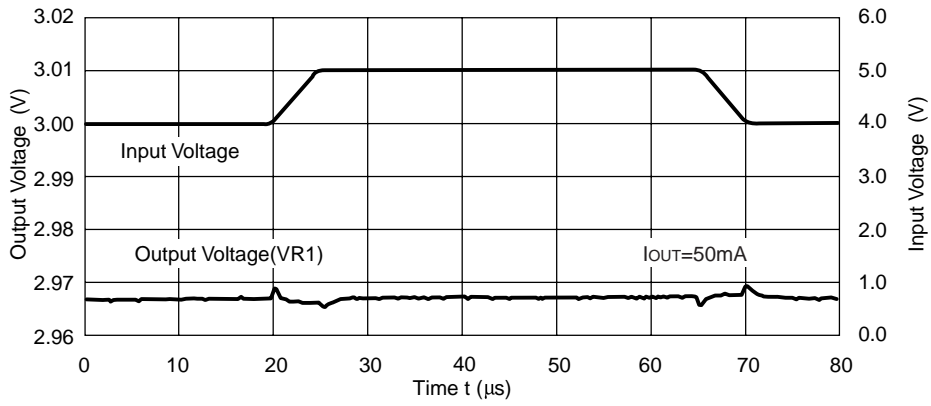

$T_r = T_f = 5\mu s$
 $C_{OUT} = \text{Tantal } 0.47\mu F$

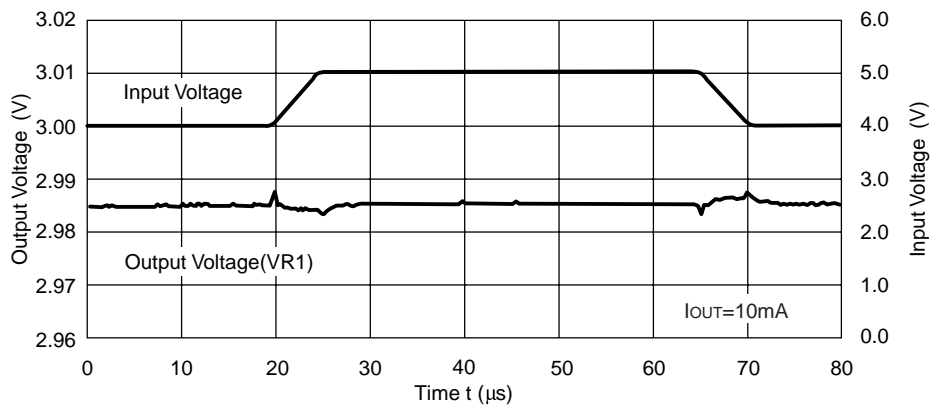
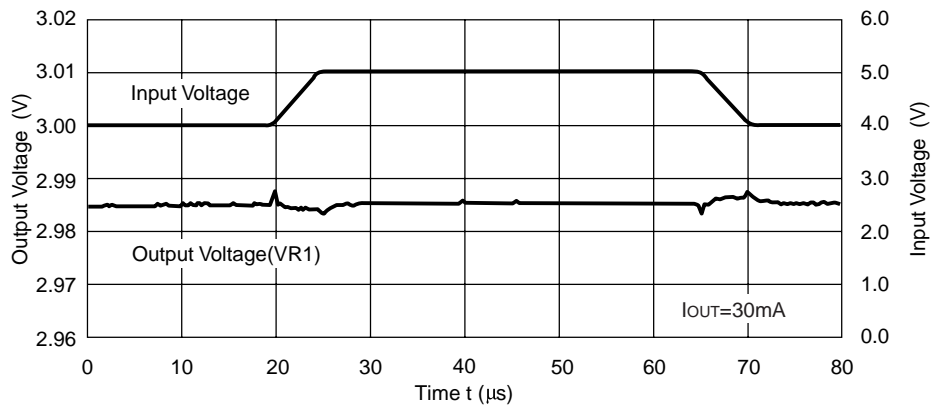
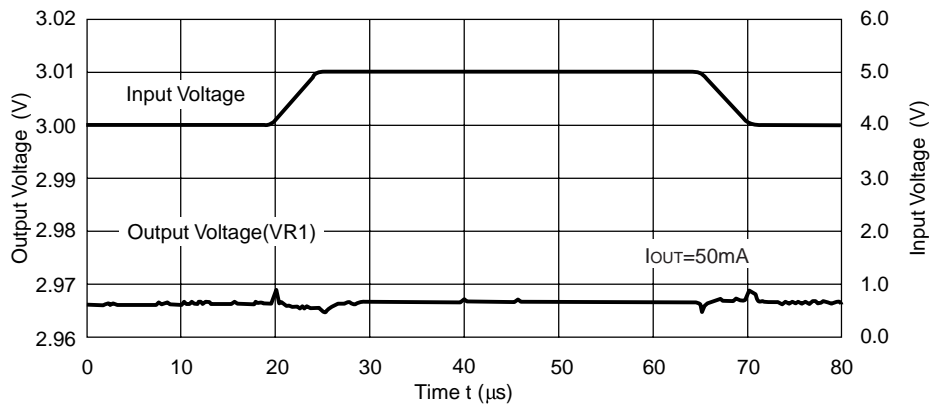

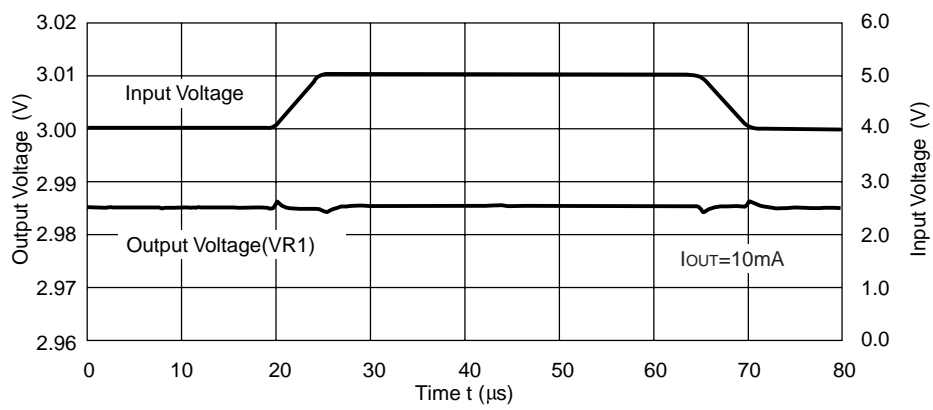
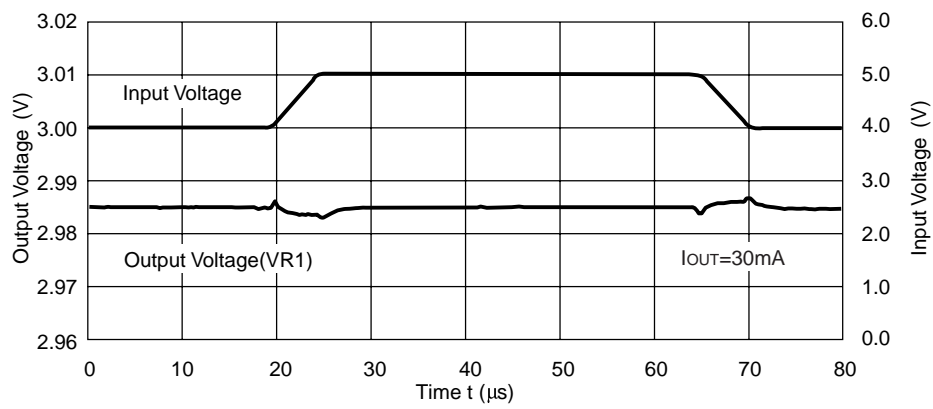
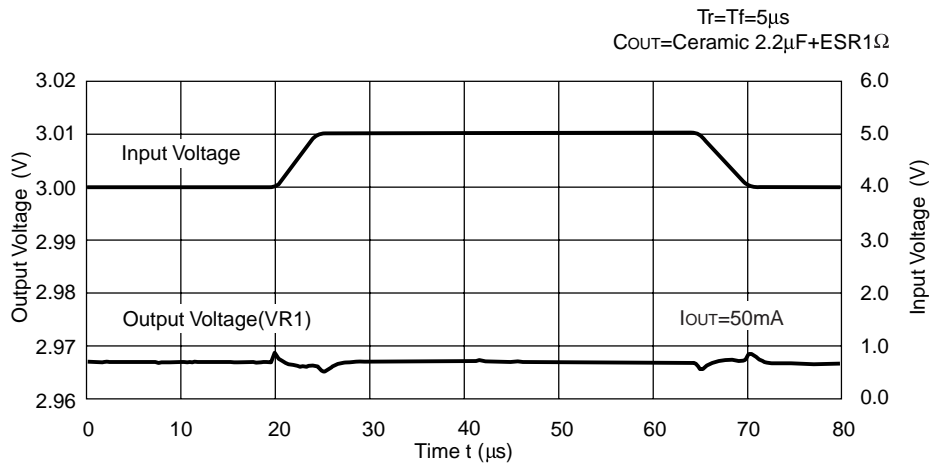

11) Load Transient Response

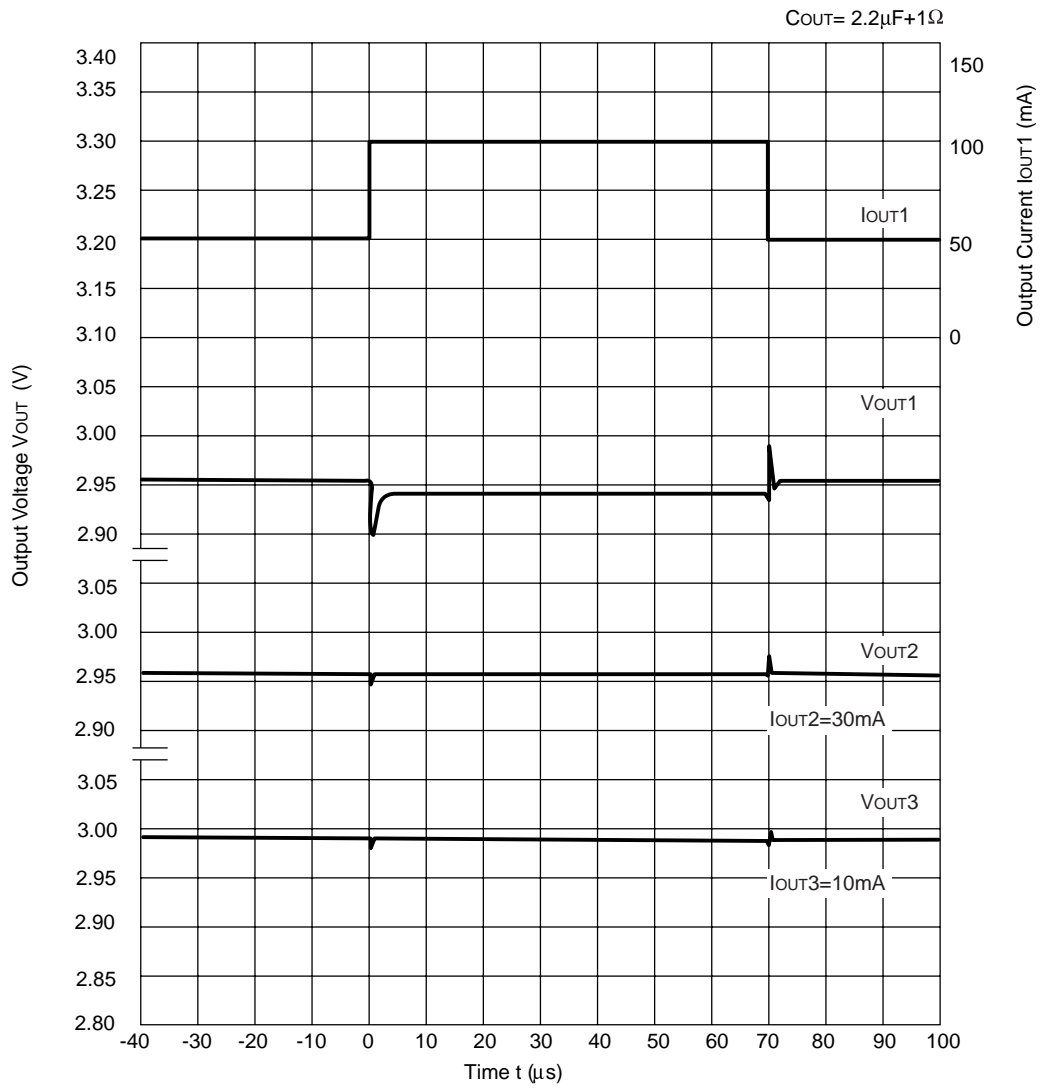

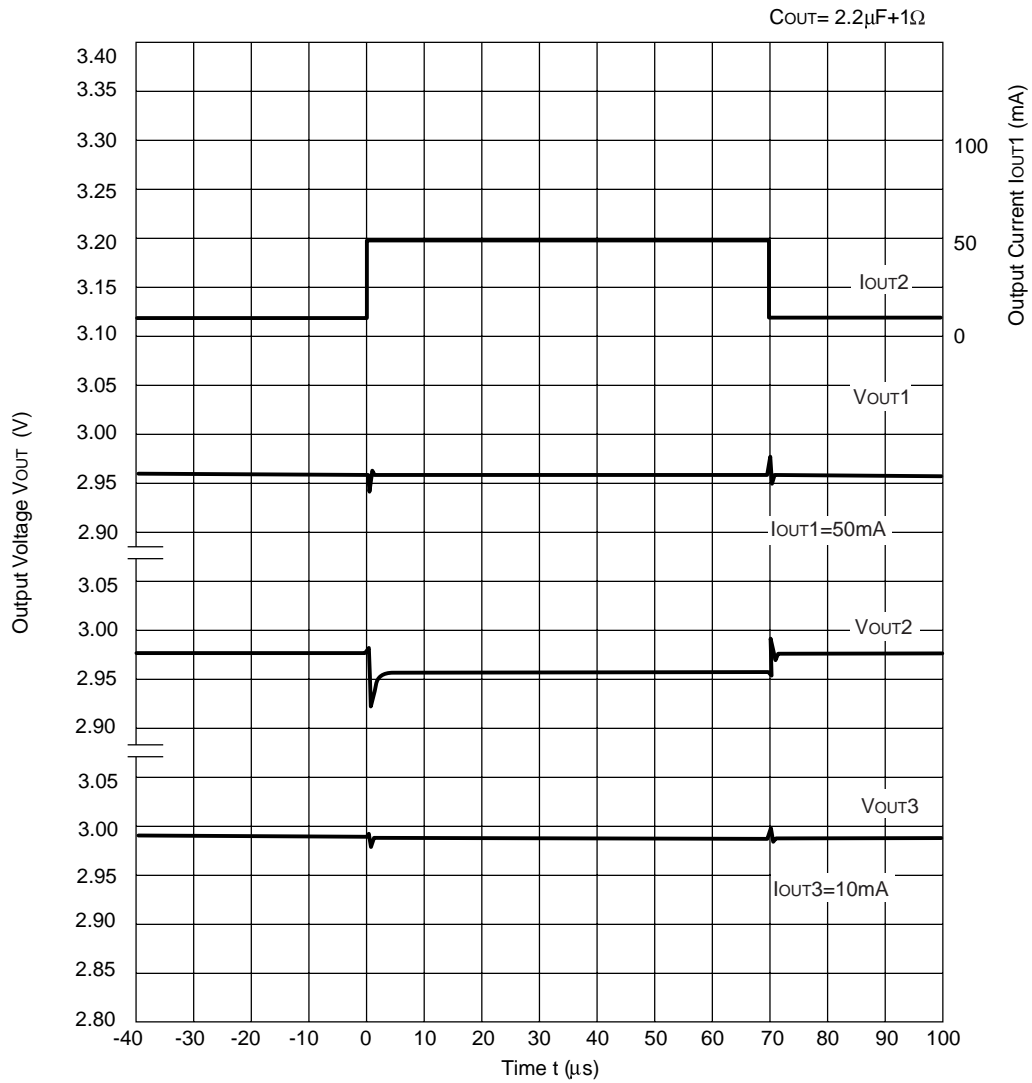

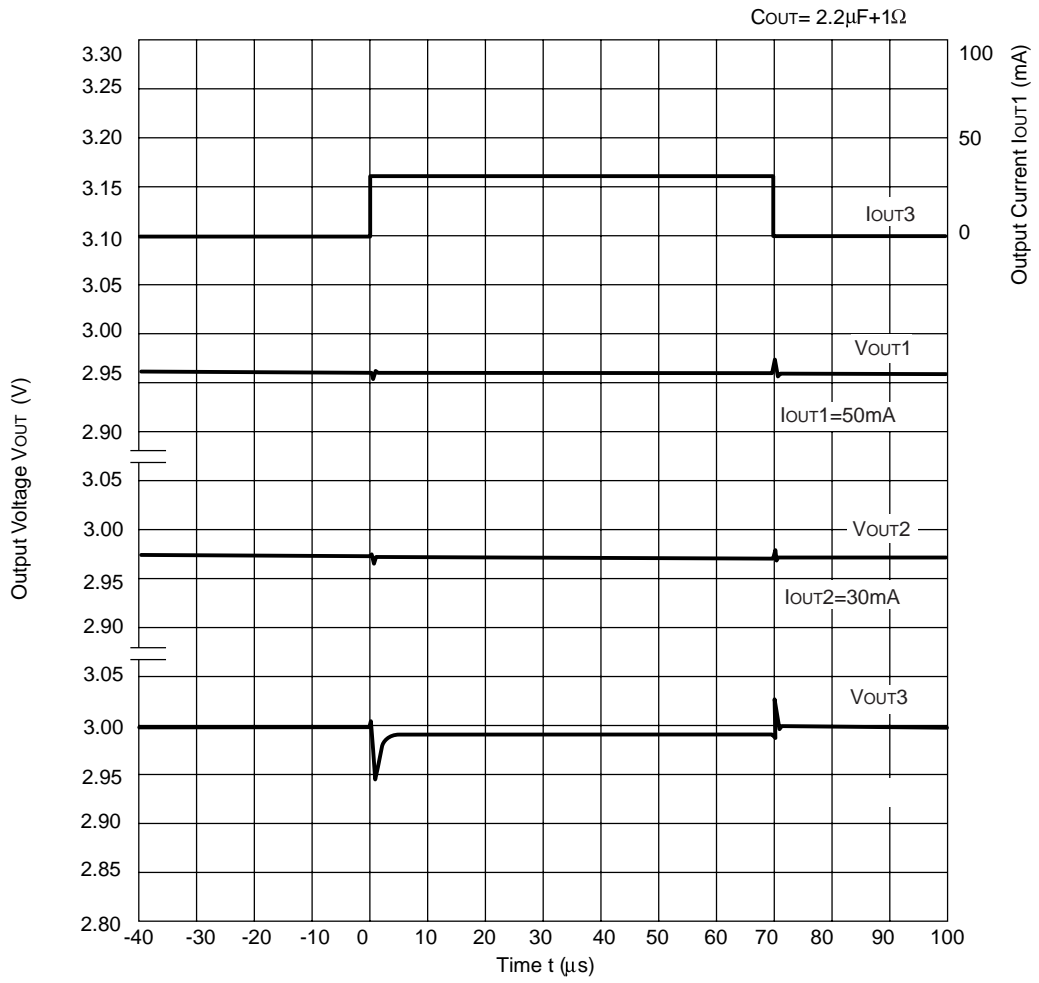

TECHNICAL NOTES

To use this IC with ceramic capacitors, ESR should be set in the range of the following graphs. Test circuit for Noise level measurement is shown below;

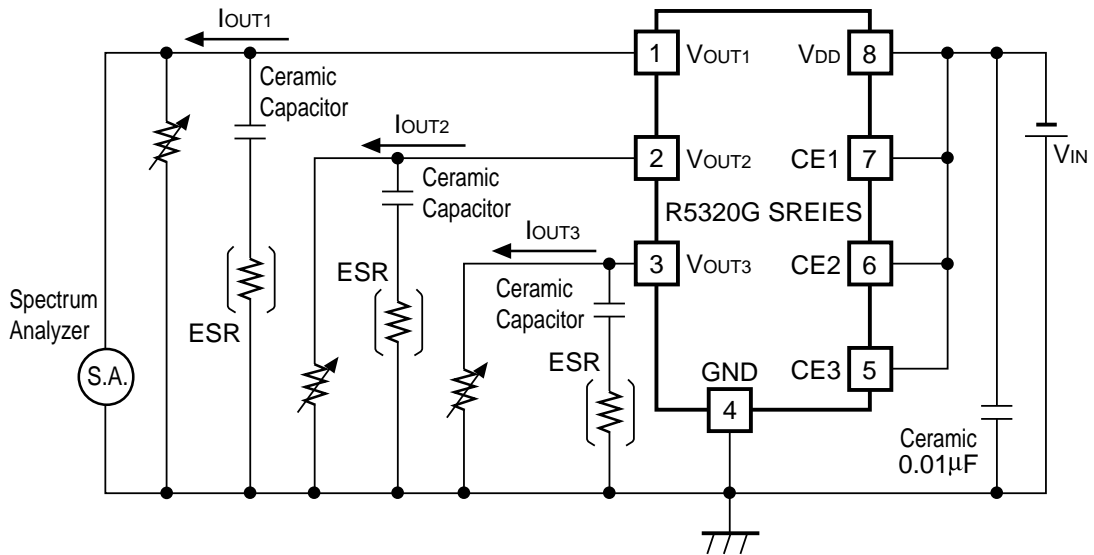

Noise level is measured with a spectrum analyzer and hatched area shows stable areas of which noise level is approximately equal or less than $40\mu\text{V}$ (Avg.). The relation between Load Current (I_{OUT}) and Equivalent Series Resistors (ESR) value of external output capacitor with the stable area is shown below;

Ceramic Capacitor $1\ \mu\text{F}$

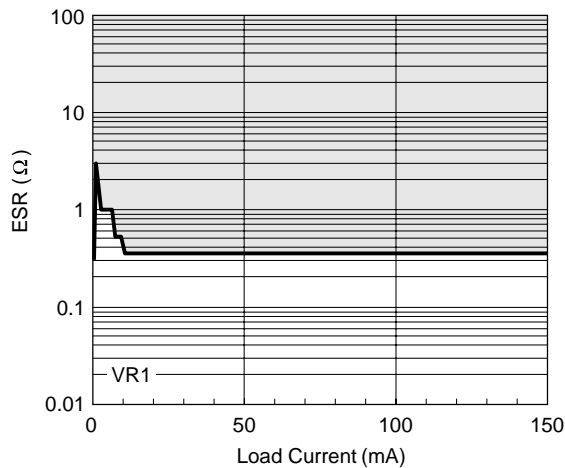

Ceramic Capacitor $2.2\ \mu\text{F}$

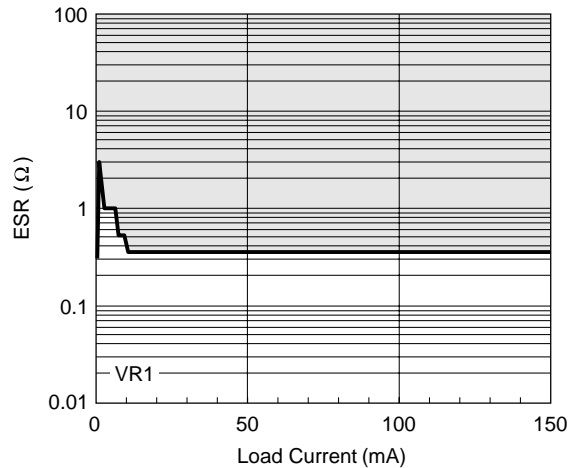

Ceramic Capacitor 1 μF

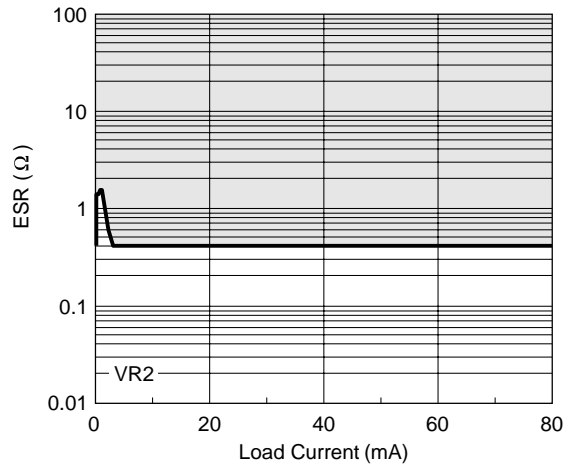

Ceramic Capacitor 2.2 μF

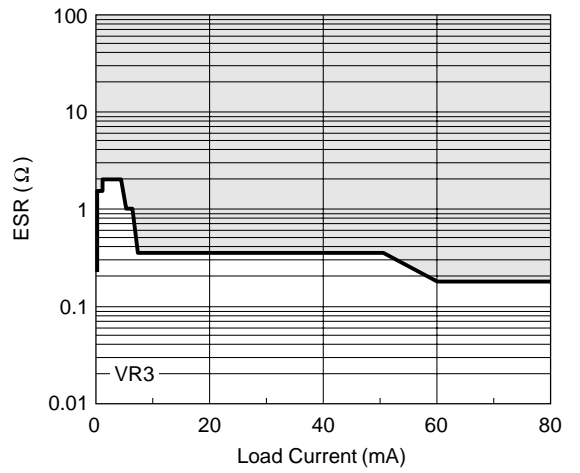
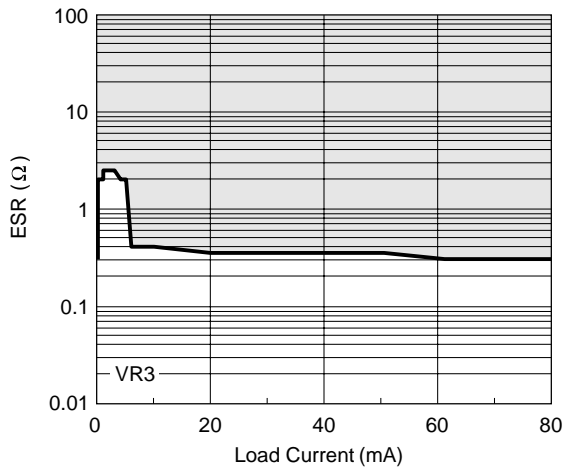
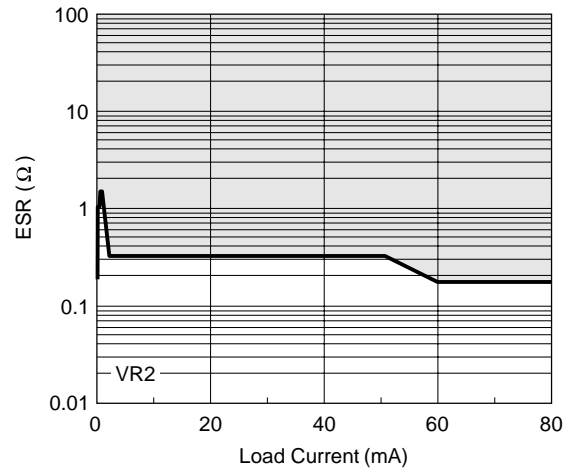

Measuring Conditions

Frequency Band : 10Hz to 1MHz

Temperature : 25°C