

■ OUTLINE

The R5323N Series are voltage regulator ICs with high output voltage accuracy, low supply current, low dropout, and high ripple rejection by CMOS process. Each of these voltage regulator ICs consists of a voltage reference unit, an error amplifier, resistors for setting Output Voltage, a current limit circuit, and a chip enable circuit.

These ICs perform with low dropout voltage due to built-in transistor with low ON resistance, and a chip enable function prolongs the battery life of each system. The line transient response and load transient response of the R5323N Series are excellent, thus these ICs are very suitable for the power supply for hand-held communication equipment.

The output voltage of these ICs is internally fixed with high accuracy. Since the package for these ICs is SOT-23-6 package, 2ch LDO regulators are included in each package, high density mounting of the ICs on boards is possible.

■ FEATURES

- Low Supply Current TYP. 90 μ A(VR1,VR2)
- Standby Mode TYP. 0.1 μ A(VR1,VR2)
- Low Dropout Voltage TYP. 0.22V(I_{OUT}=150mA Output Voltage=3.0V Type)
- High Ripple Rejection TYP. 75dB(V_{OUT}≤2.4V), TYP. 70dB(V_{OUT}≥2.5V) (f=1kHz)
..... TYP. 65dB(V_{OUT}≤2.4V), TYP. 60dB(V_{OUT}≥2.5V) (f=10kHz)
- Low Temperature-Drift Coefficient of Output Voltage TYP. \pm 100ppm/ $^{\circ}$ C
- Excellent Line Regulation TYP. 0.02%/V
- High Output Voltage Accuracy \pm 2.0%
- Small Package SOT-23-6
- Output Voltage Stepwise setting with a step of 0.1V in the range of 1.5V to 4.0V is possible
- Built-in chip enable circuit (A/B: active high)
- Built-in fold-back protection circuit TYP. 40mA (Current at short mode)
- Ceramic Capacitor is recommended. (1 μ F or more)

■ APPLICATIONS

- Power source for handheld communication equipment.
- Power source for electrical appliances such as cameras, VCRs and camcorders.
- Power source for battery-powered equipment.

■ BLOCK DIAGRAM

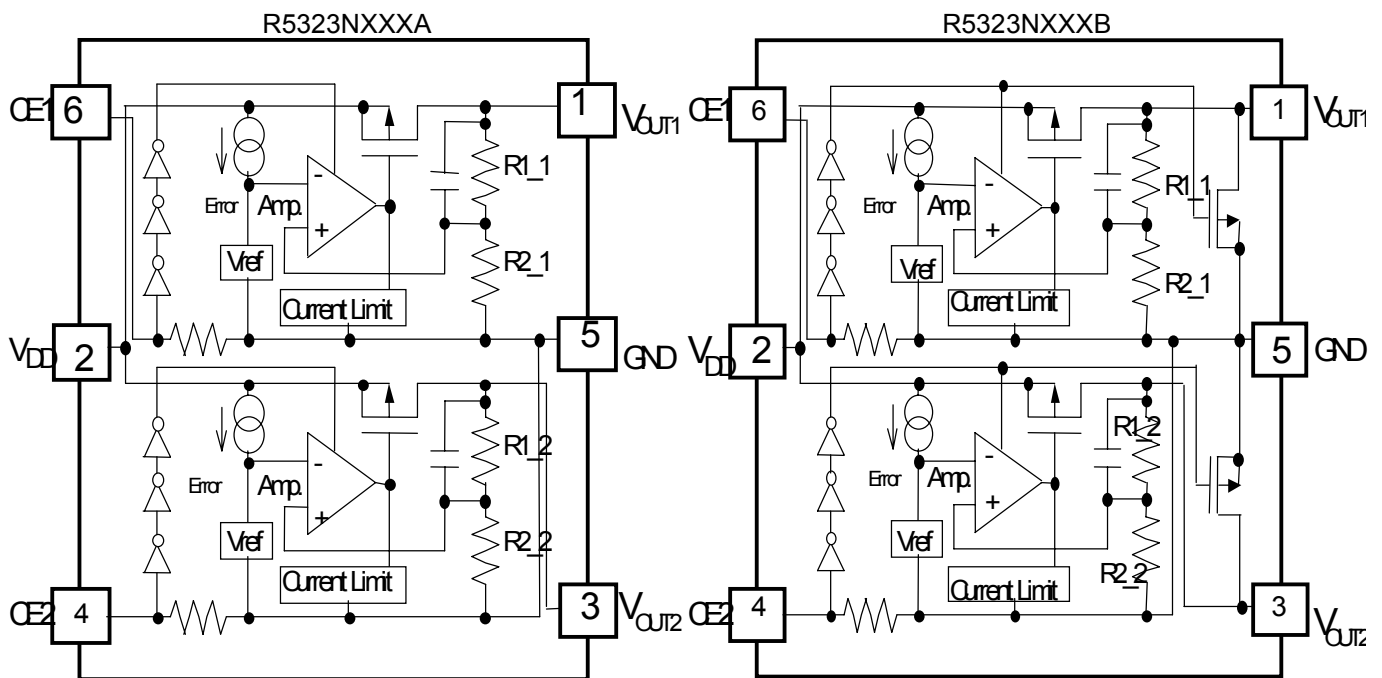

■ SELECTION GUIDE

The output voltage, mask option, and the taping type for the ICs can be selected at the user's request. The selection can be made with designating the part number as shown below;

R5323NXXXX-XX ←Part Number
 ↑ ↑ ↑
 a b c

Code	Contents
a	Setting combination of 2ch Output Voltage (V_{OUT}) : Serial Number for Voltage Setting, Stepwise setting with a step of 0.1V in the range of 1.5V to 4.0V is possible for each channel.
b	Designation of Mask Option : A version: without auto discharge function at OFF state. B version: with auto discharge function at OFF state.
c	Designation of Taping Type : Ex. TR (refer to Taping Specifications; TR type is the standard direction.)

■ PIN CONFIGURATION

SOT-23-6

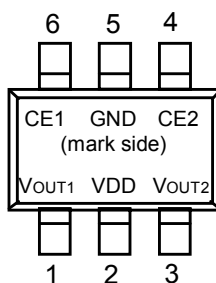

■ PIN DESCRIPTION

Pin No.	Symbol	Description
1	V _{OUT1}	Output Pin 1
2	V _{DD}	Input Pin
3	V _{OUT2}	Output Pin 2
4	CE2	Chip Enable Pin 2
5	GND	Ground Pin
6	CE1	Chip Enable Pin 1

■ ABSOLUTE MAXIMUM RATINGS

Item	Symbol	Rating	Unit
Input Voltage	V _{IN}	6.5	V
Input Voltage(CE Pin)	V _{CE}	-0.3 ~ V _{IN} +0.3	V
Output Voltage	V _{OUT}	-0.3 ~ V _{IN} +0.3	V
Output Current 1	I _{OUT1}	200	mA
Output Current 2	I _{OUT2}	200	mA
Power Dissipation	P _D	250	mW
Operating Temperature Range	T _{opt}	-40 ~ 85	°C
Storage Temperature Range	T _{stg}	-55 ~ 125	°C

ELECTRICAL CHARACTERISTICS

R5323NXXXA/B

Topt=25°C

Symbol	Item	Conditions	MIN.	TYP.	MAX.	Unit
V _{OUT}	Output Voltage	V _{IN} = Set V _{OUT} +1V 1mA ≤ I _{OUT} ≤ 30mA	V _{OUT} ×0.98		V _{OUT} ×1.02	V
I _{OUT}	Output Current	V _{IN} - V _{OUT} = 1.0V	150			mA
ΔV _{OUT} /ΔI _{OUT}	Load Regulation	V _{IN} = Set V _{OUT} +1V 1mA ≤ I _{OUT} ≤ 150mA		15	40	mV
V _{DIF}	Dropout Voltage	Refer to the ELECTRICAL CHARACTERISTICS by OUTPUT VOLTAGE				
I _{SS}	Supply Current	V _{IN} = Set V _{OUT} +1V		90	120	μA
I _{standby}	Supply Current (Standby)	V _{IN} = Set V _{OUT} +1V V _{CE} = GND		0.1	1.0	μA
ΔV _{OUT} /ΔV _{IN}	Line Regulation	Set V _{OUT} +0.5V ≤ V _{IN} ≤ 6V I _{OUT} = 30mA		0.02	0.10	%/V
RR	Ripple Rejection	Ripple 0.5Vp-p V _{IN} = Set V _{OUT} +1V I _{OUT} = 30mA (In case that V _{OUT} ≤1.7V, V _{IN} = Set V _{OUT} +1.2V)		75 *Note1 65 *Note2		dB
V _{IN}	Input Voltage		2.0		6.0	V
ΔV _{OUT} /ΔT	Output Voltage Temperature Coefficient	I _{OUT} = 30mA -40°C ≤ Topt ≤ 85°C		±100		ppm /°C
I _{lim}	Short Current Limit	V _{OUT} = 0V		40		mA
R _{PD}	CE Pull-down Resistance		0.7	2.0	8.0	MΩ
V _{CEH}	CE Input Voltage "H"		1.5		V _{IN}	V
V _{CEL}	CE Input Voltage "L"		0.0		0.3	V
e _n	Output Noise	BW=10Hz to 100kHz		30		μVrms
R _{LOW}	Low Output Nch Tr. ON Resistance (of B version)	V _{CE} =0V		60		Ω

Note1: f=1kHz, 70dB as to V_{OUT}≥2.5V Output type.

Note2: f=10kHz, 60dB as to V_{OUT}≥2.5V Output type.

ELECTRICAL CHARACTERISTICS by OUTPUT VOLTAGE

Topt = 25°C

Output Voltage V _{OUT} (V)	Dropout Voltage		
	V _{DIF} (V)		
	Condition	TYP.	MAX.
V _{OUT} = 1.5	I _{OUT} = 150mA	0.38	0.70
V _{OUT} = 1.6		0.35	0.65
V _{OUT} = 1.7		0.33	0.60
1.8 ≤ V _{OUT} ≤ 2.0		0.32	0.55
2.1 ≤ V _{OUT} ≤ 2.7		0.28	0.50
2.8 ≤ V _{OUT} ≤ 4.0		0.22	0.35

*Recommended Ceramic capacitor for Output: GRM219R61A105K(Murata)

General Example of External Components

Ceramic Capacitors: C1608X5R0J105K (TDK)

GRM188R60J105K (Murata)

TEST CIRCUITS

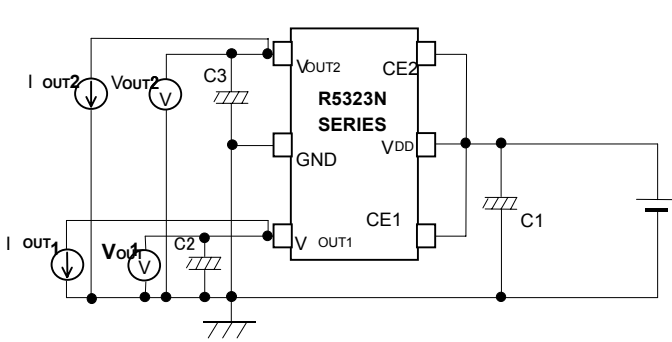

Fig.1 Standard test Circuit

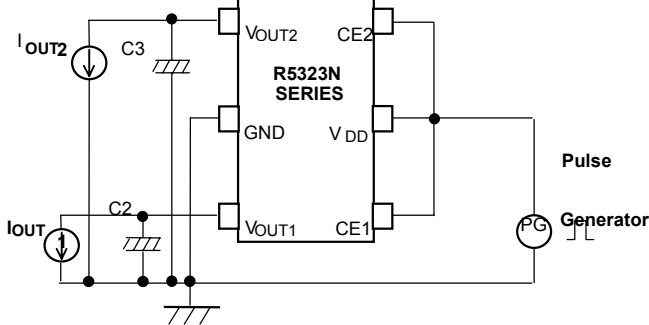

Fig.3 Ripple Rejection, Line Transient Response Test Circuit

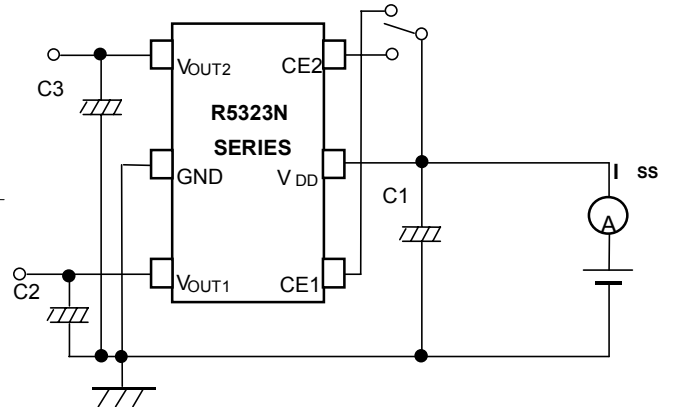

Fig.2 Supply Current Test Circuit

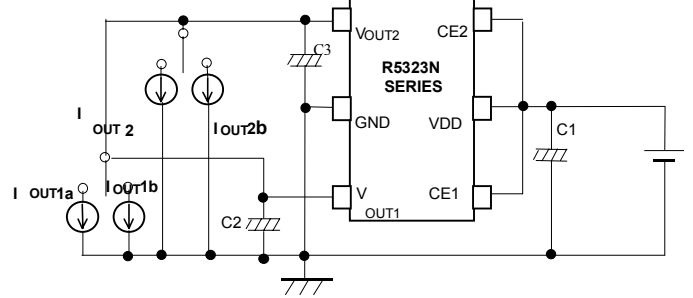
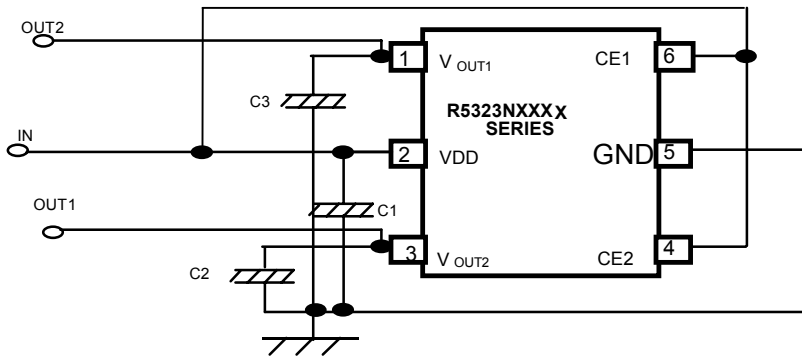

Fig.4 Load Transient Response Test Circuit

TYPICAL APPLICATION



(External Components) Output Capacitor; Ceramic Type

TYPICAL CHARACTERISTICS

1) Output Voltage vs. Output Current (Topt=25°C)

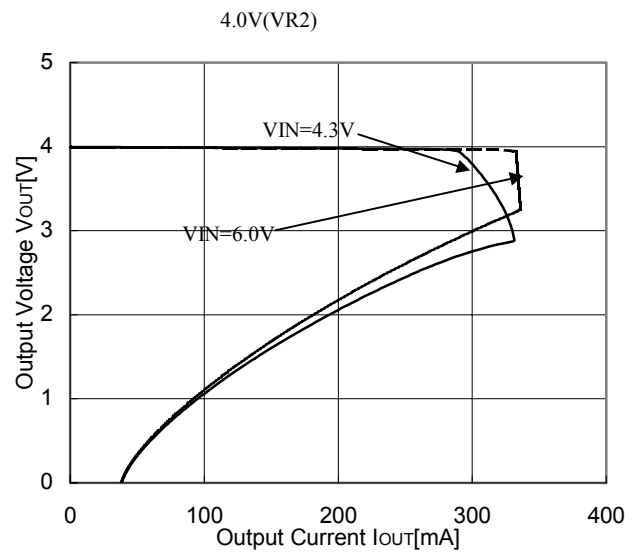
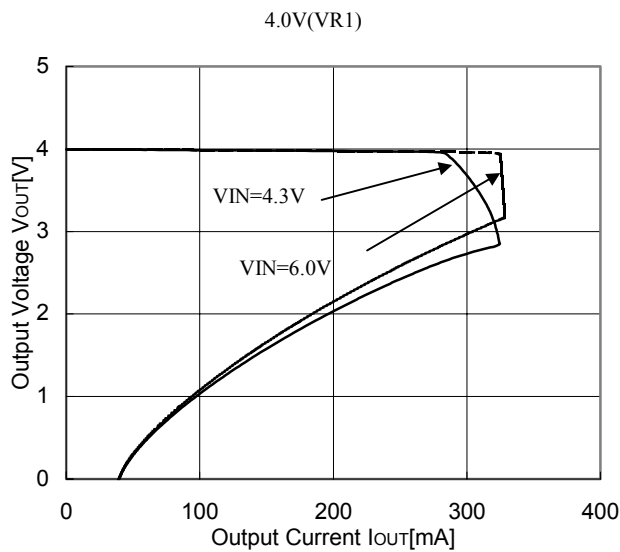
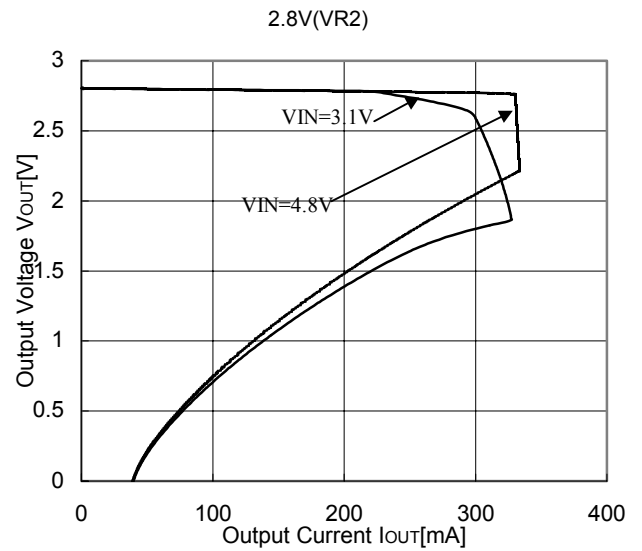
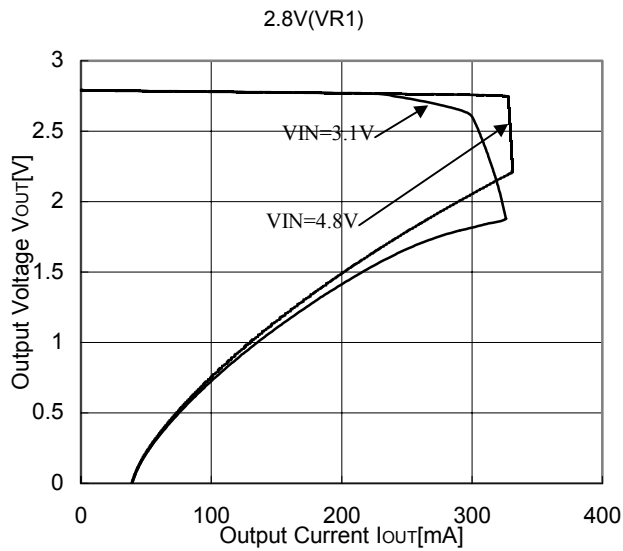
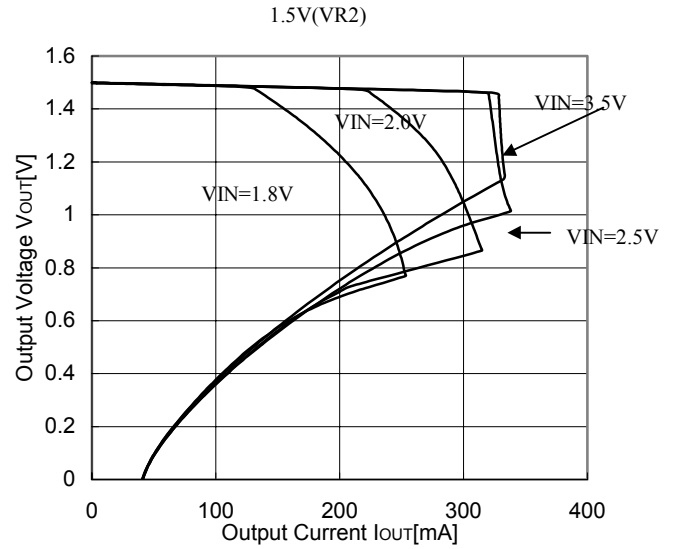
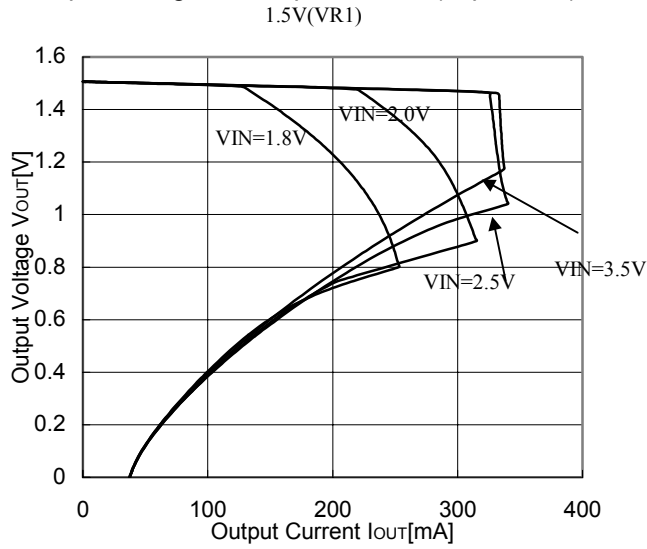

2) Output Voltage vs. Input Voltage (T_{opt}=25°C)
1.5V(VR1)

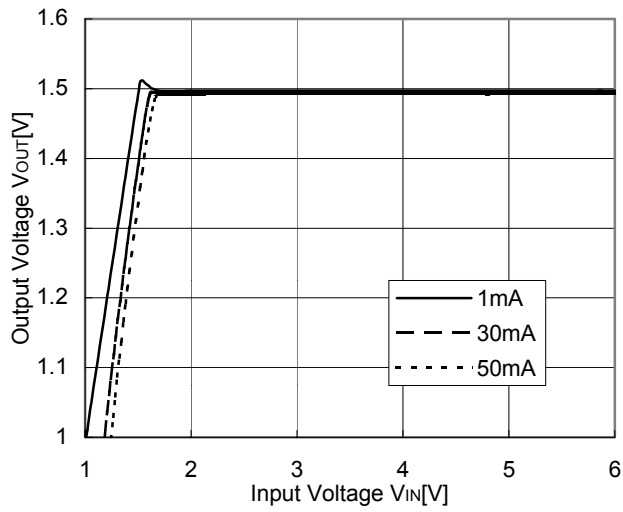

1.5V(VR2)

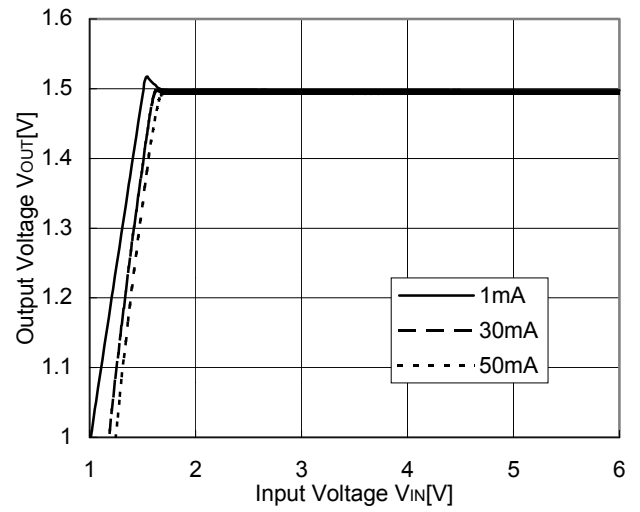

2.8V(VR1)

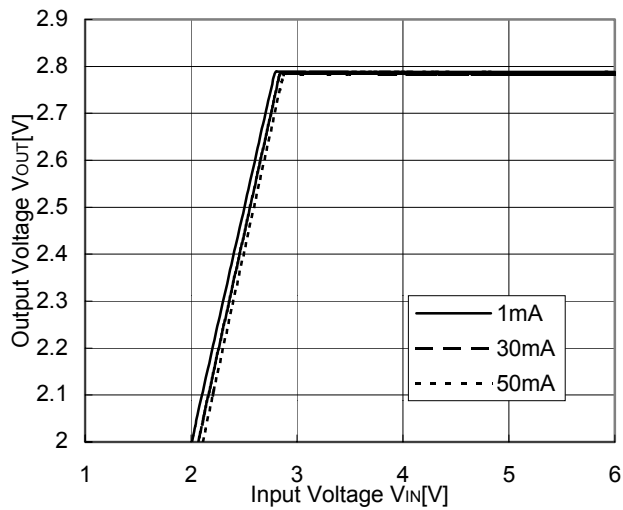

2.8V(VR2)

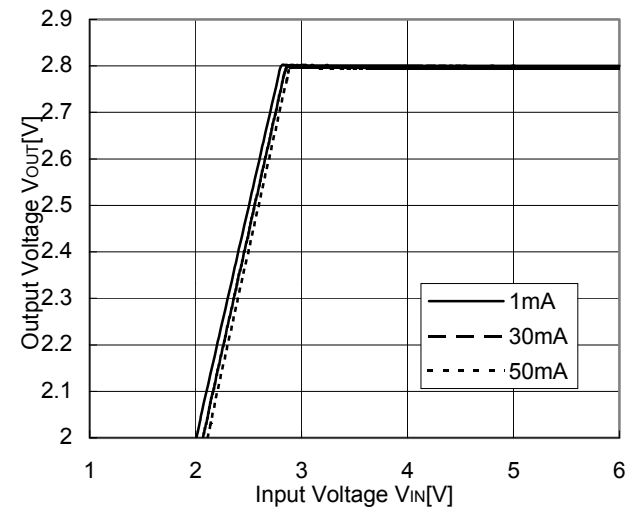

4.0V(VR1)

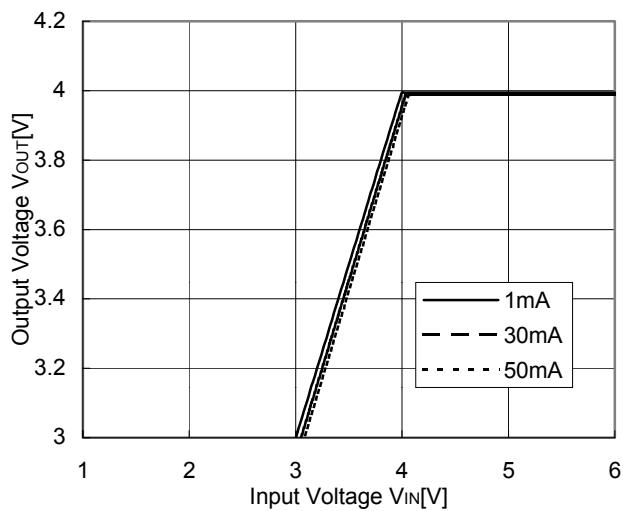

4.0V(VR2)

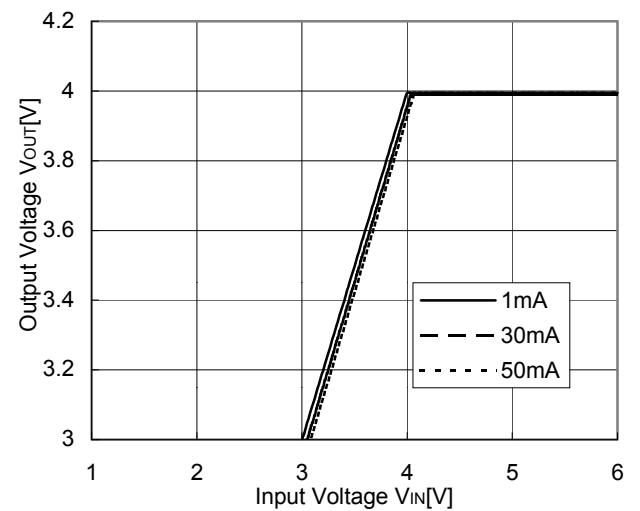

3) Dropout Voltage vs. Temperature

1.5V(VR1)

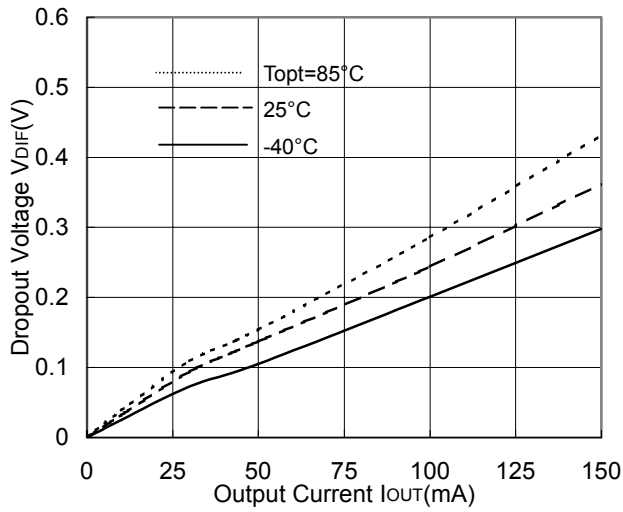

1.5V(VR2)

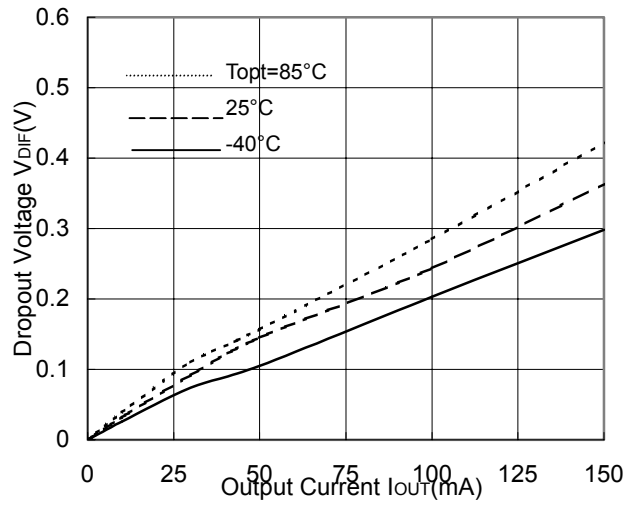

2.8V(VR1)

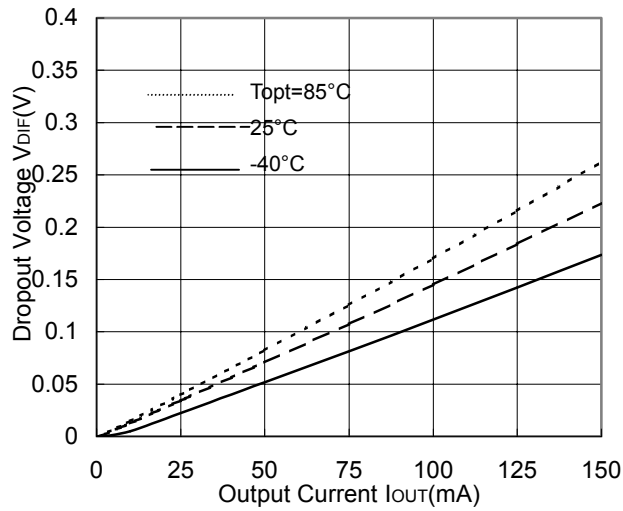

2.8V(VR2)

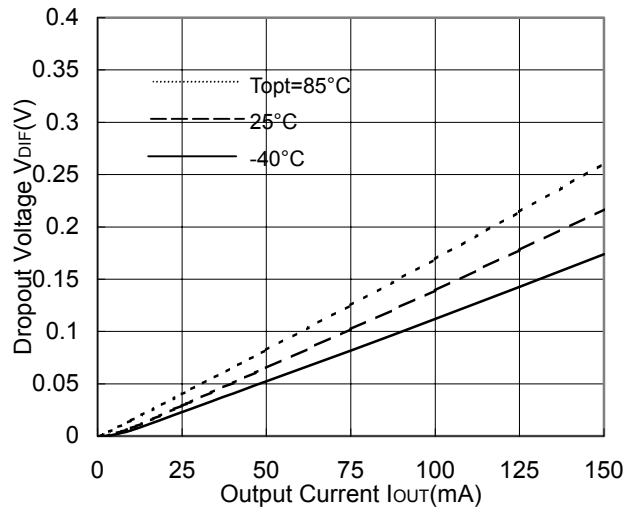

4.0V(VR1)

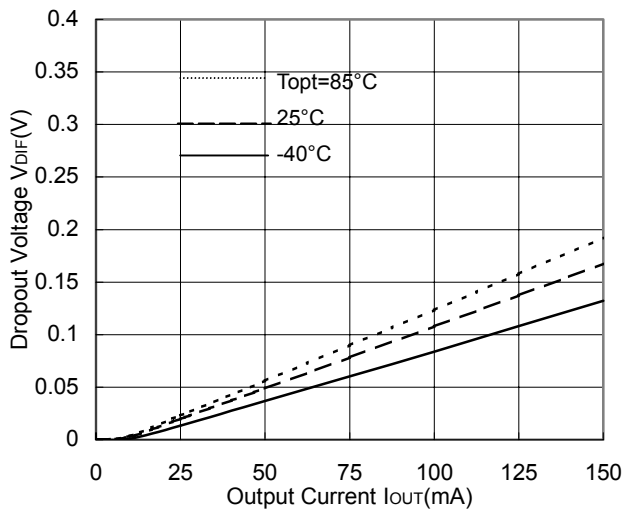

4.0V(VR2)

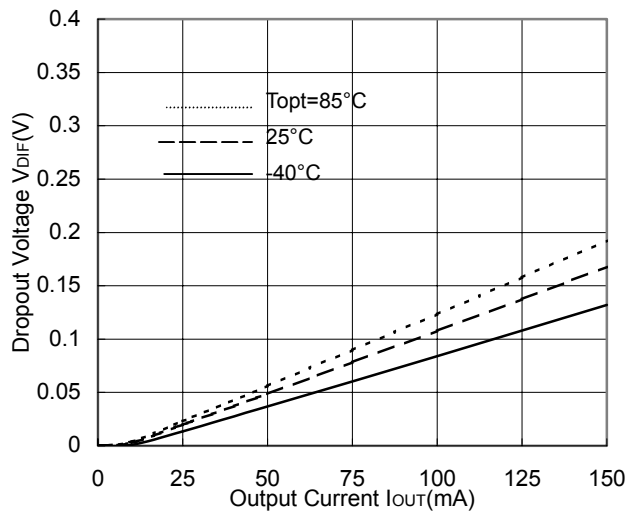

4) Output Voltage vs. Temperature

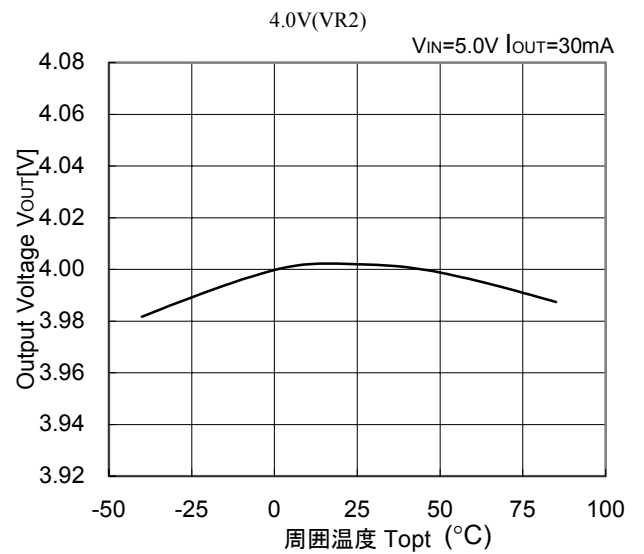
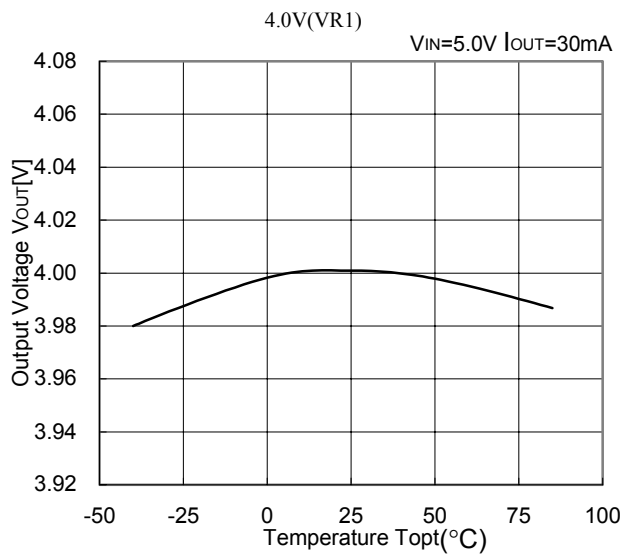
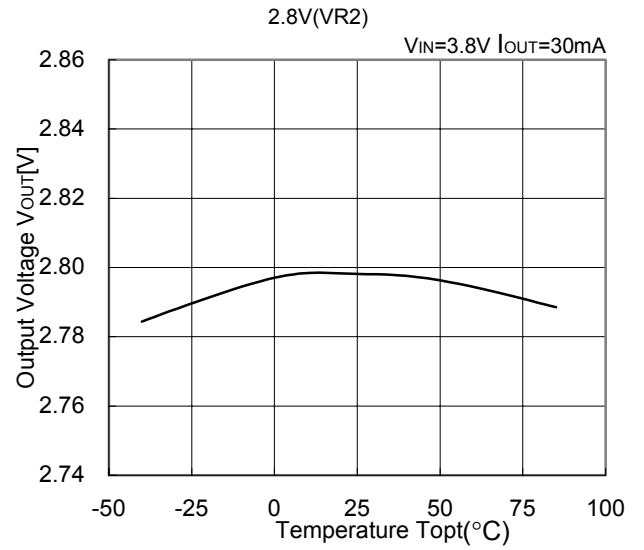
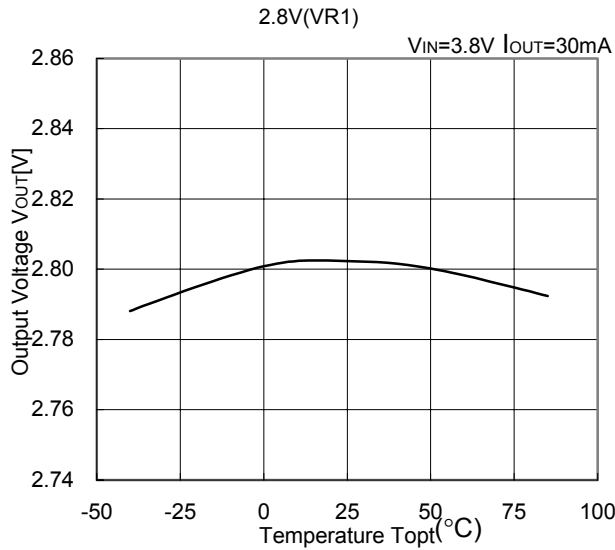
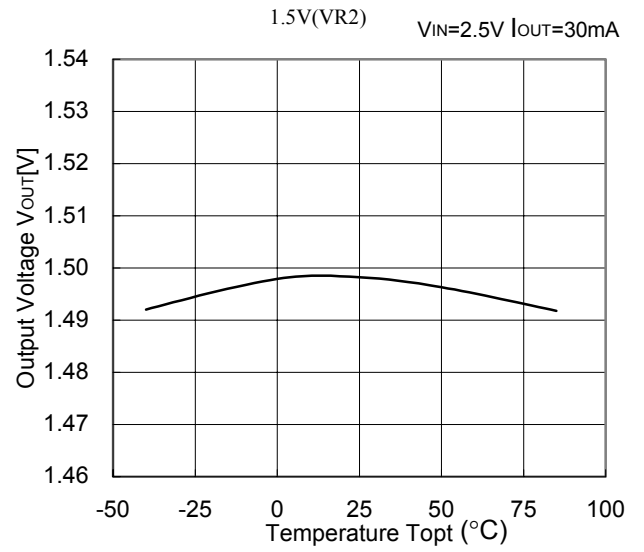
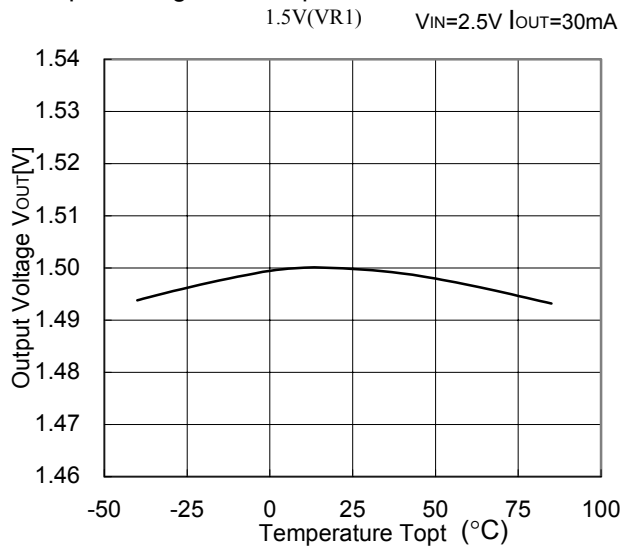

5) Supply Current vs. Input Voltage (T_{opt}=25°C)

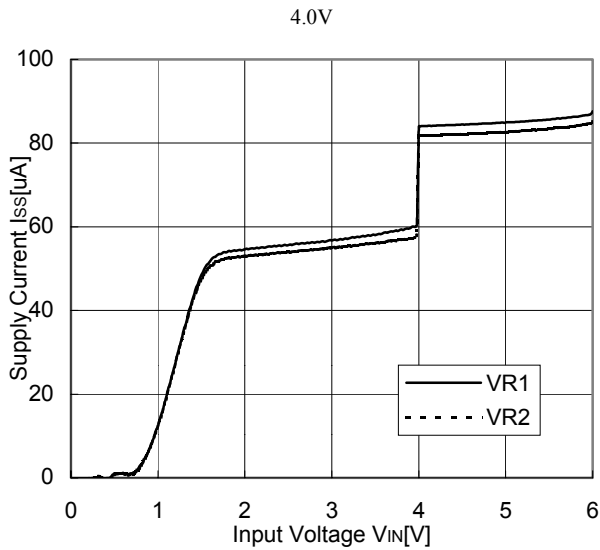
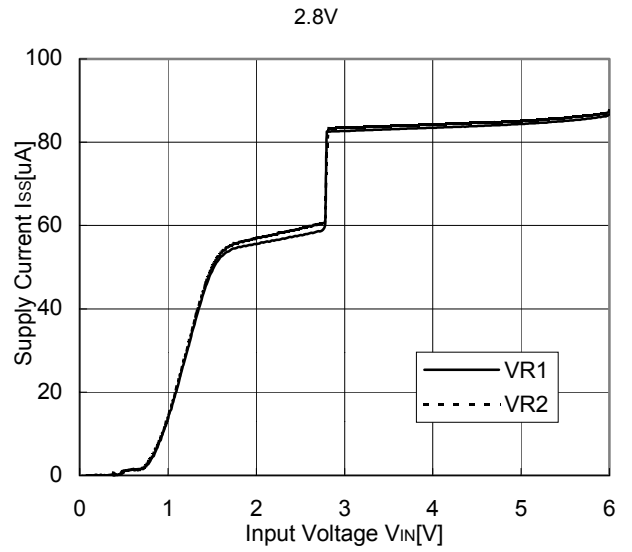
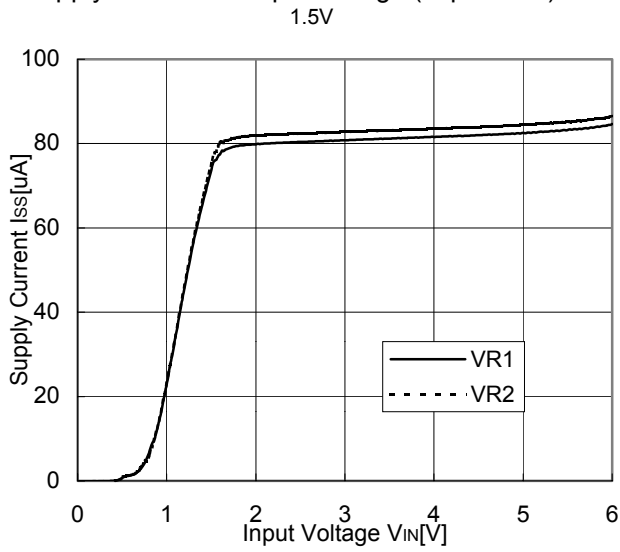

6) Supply Current vs. Temperature

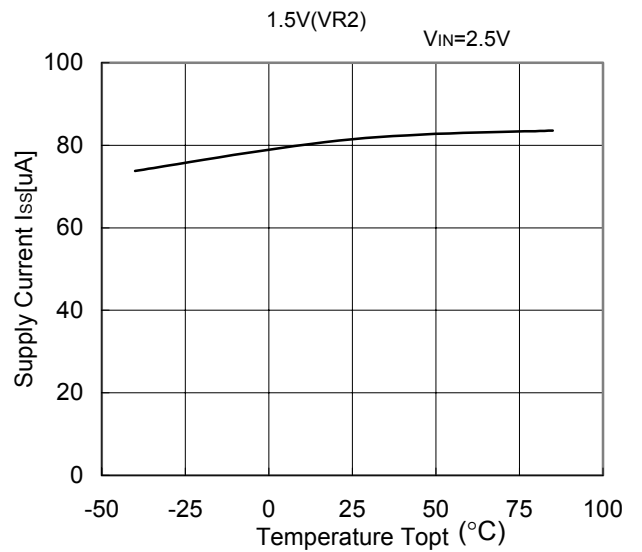
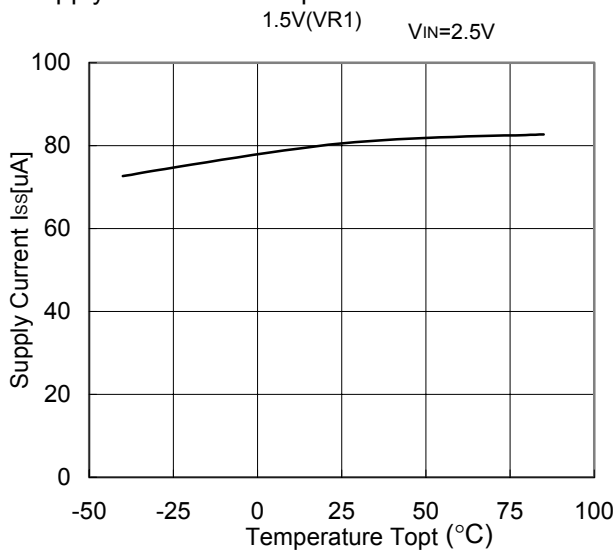

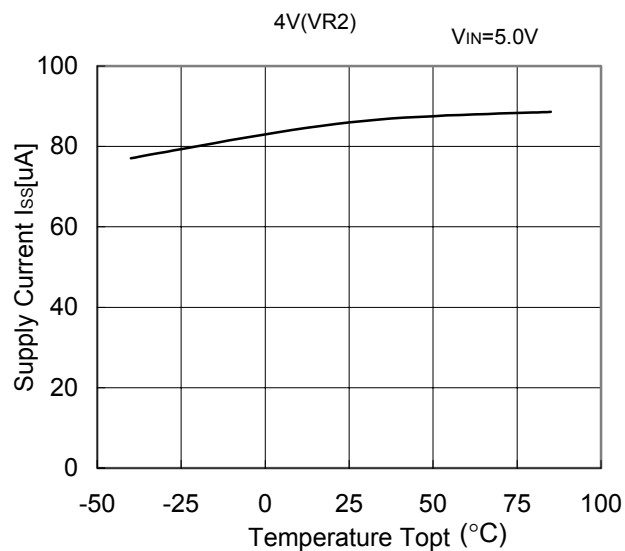
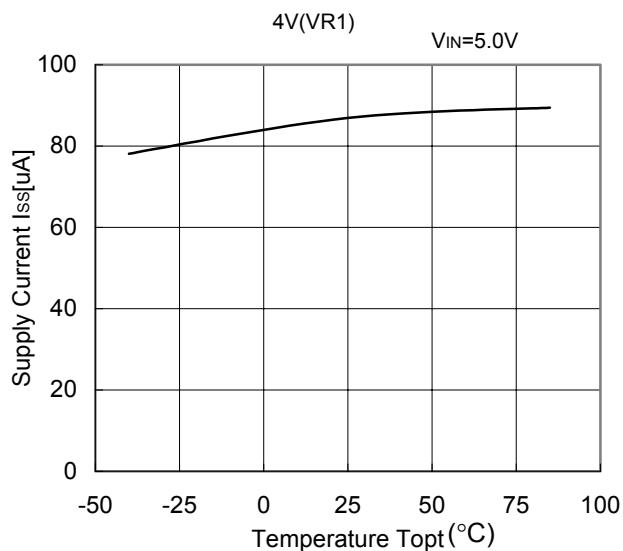
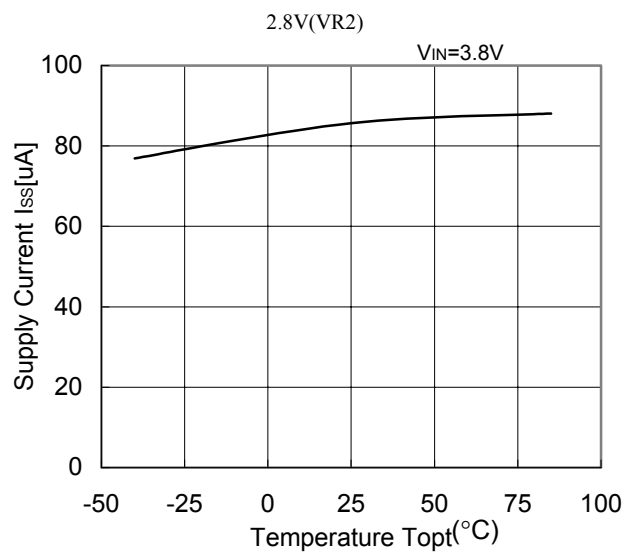
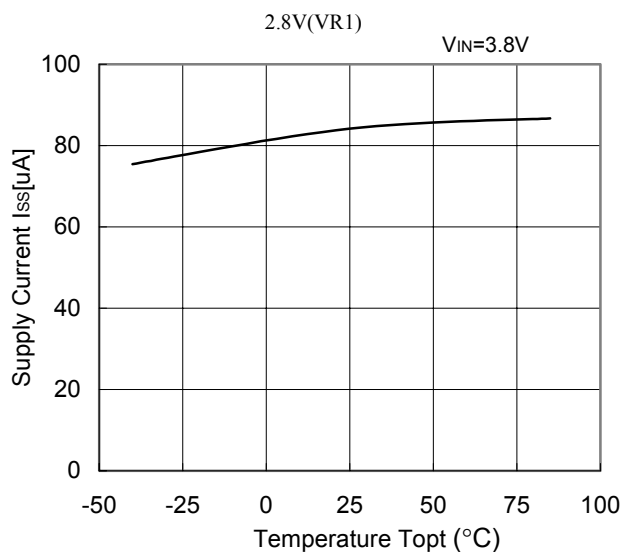

7) Dropout Voltage vs. Set Output Voltage
VR1

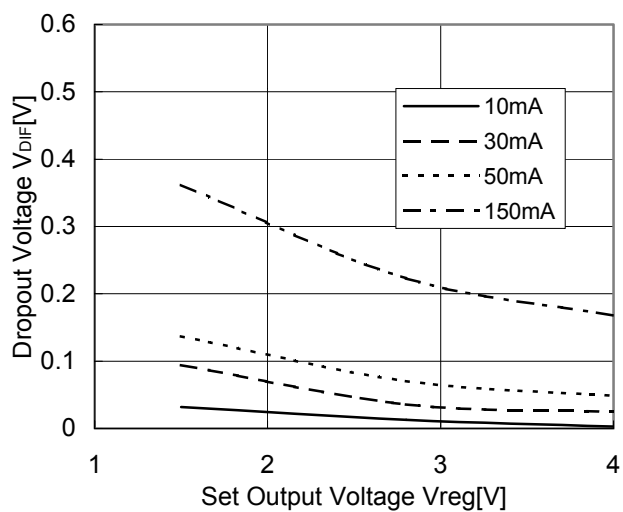

$T_{opt}=25^\circ C$

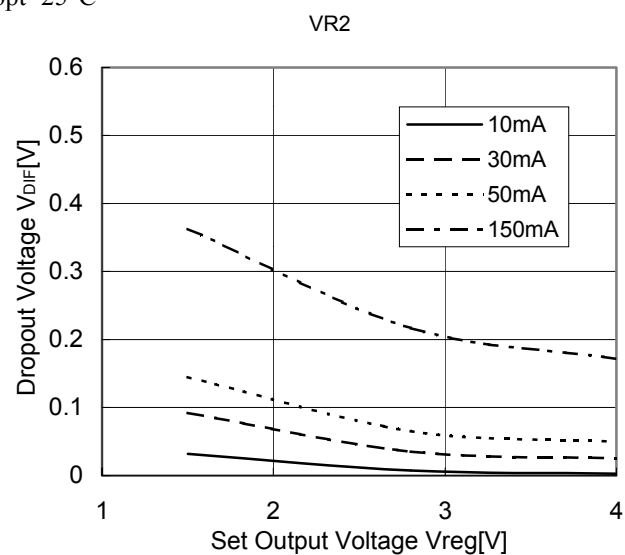

8) Ripple Rejection vs. Frequency ($T_{opt}=25^{\circ}C$)

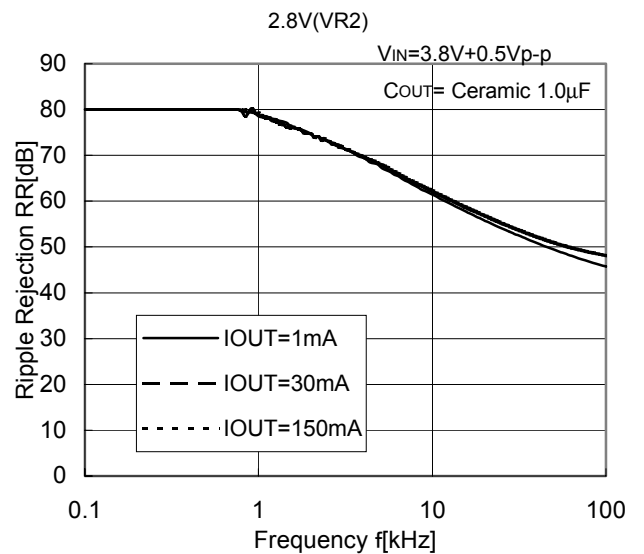
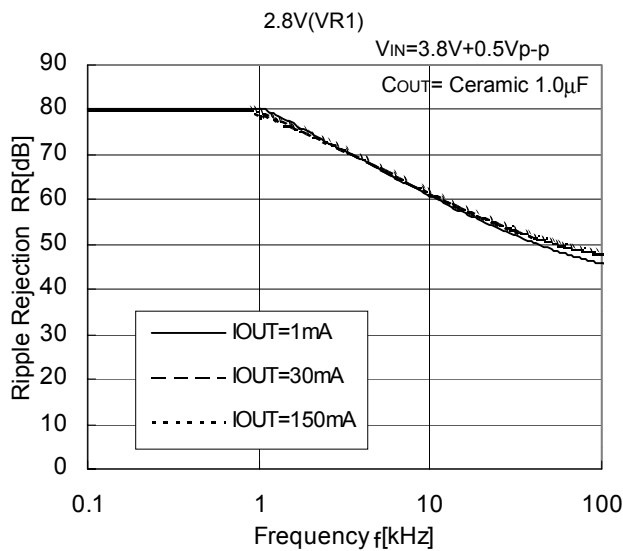
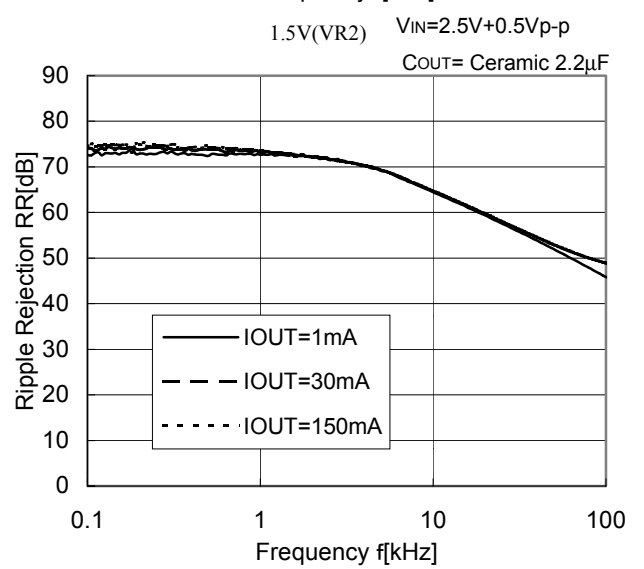
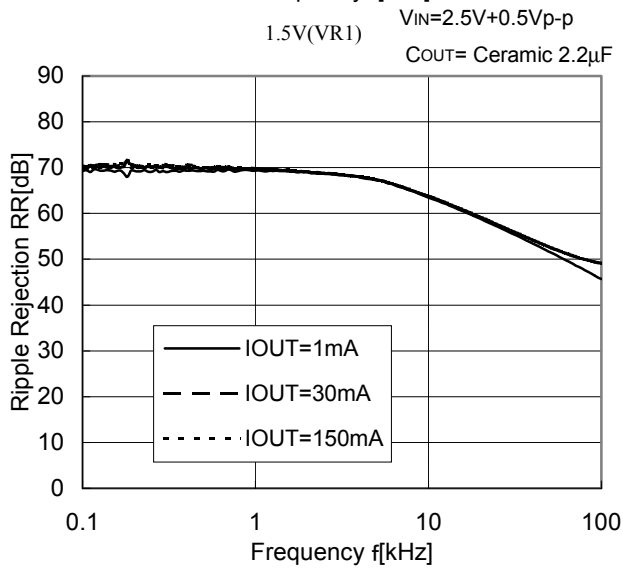
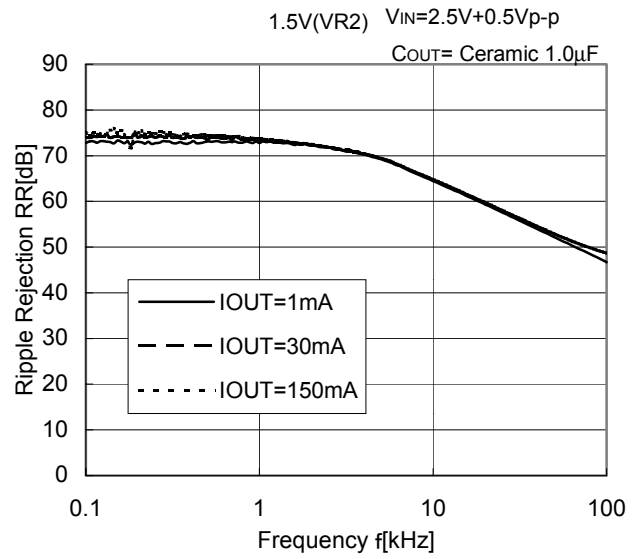
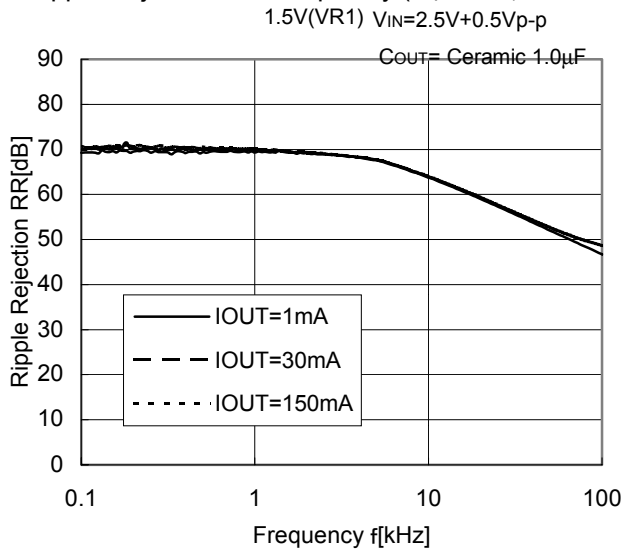

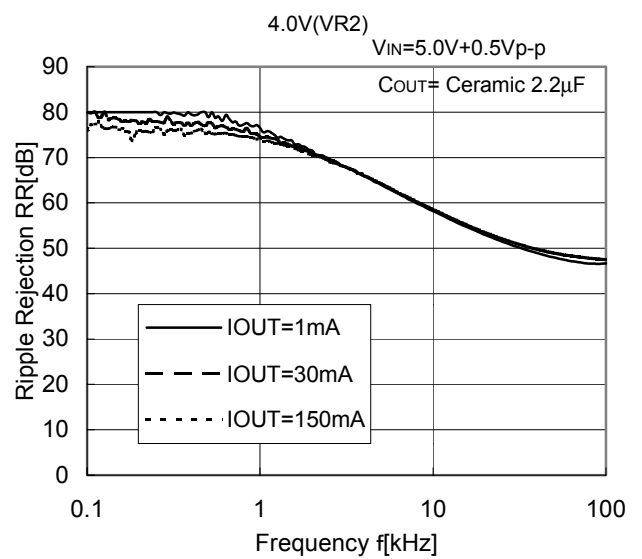
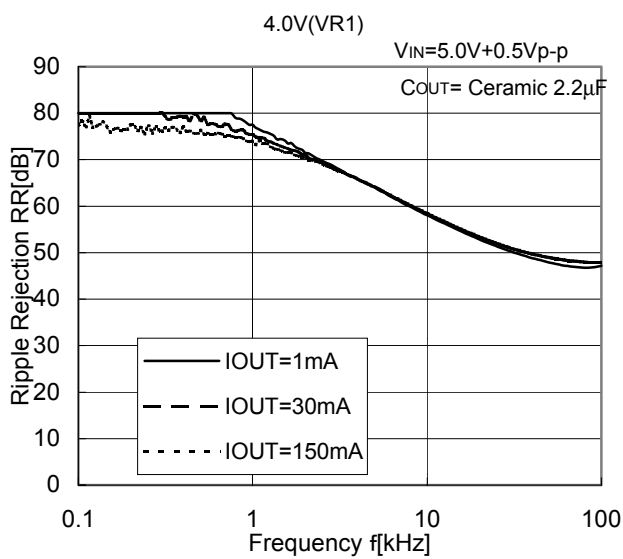
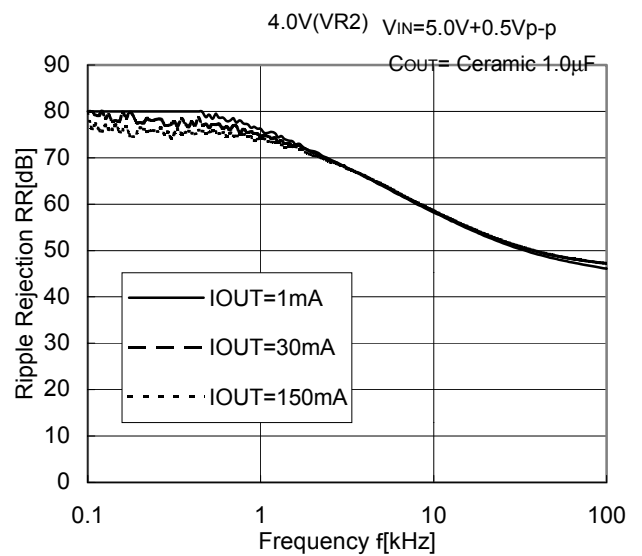
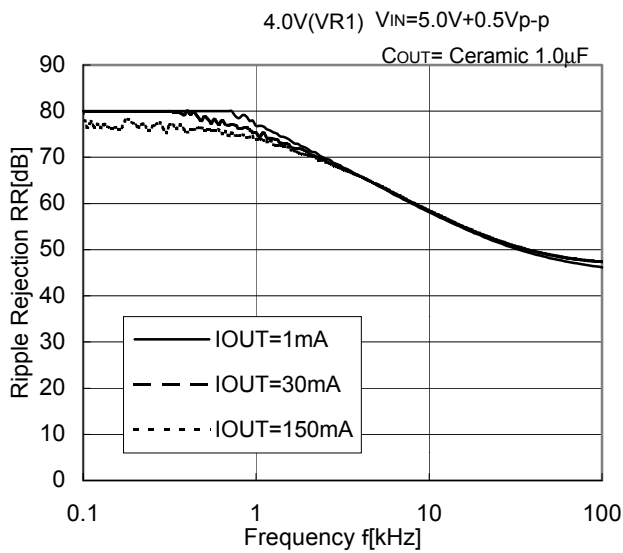
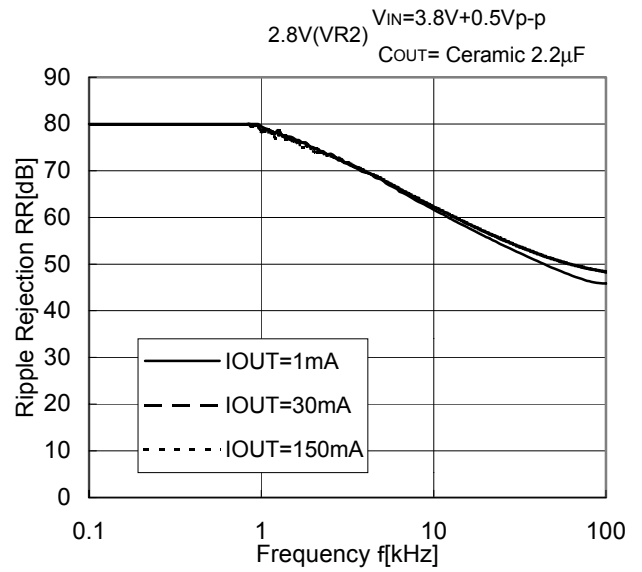
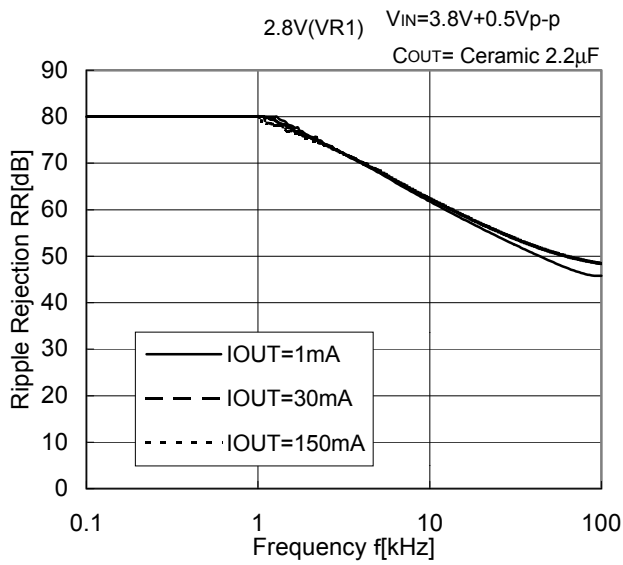

9) Ripple Rejection vs. Input Voltage (DC bias) $C_{OUT} = \text{Ceramic } 1.0\mu\text{F}$, $T_{opt}=25^{\circ}\text{C}$

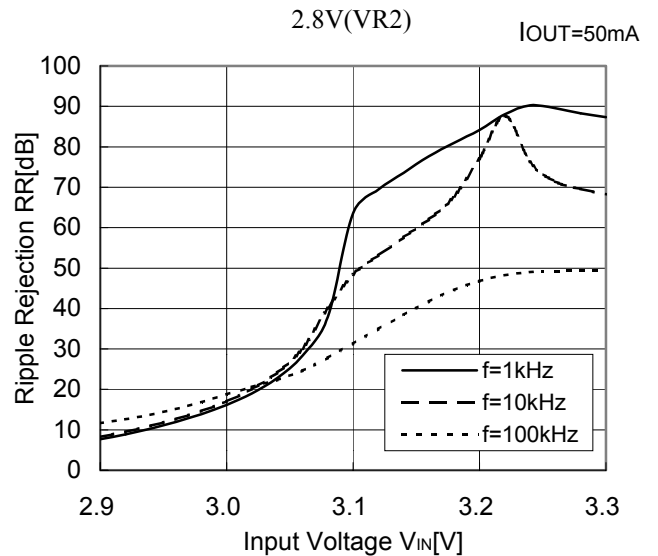
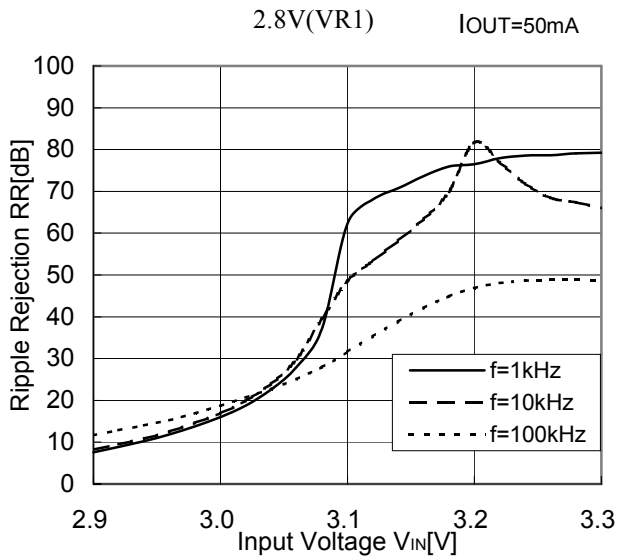
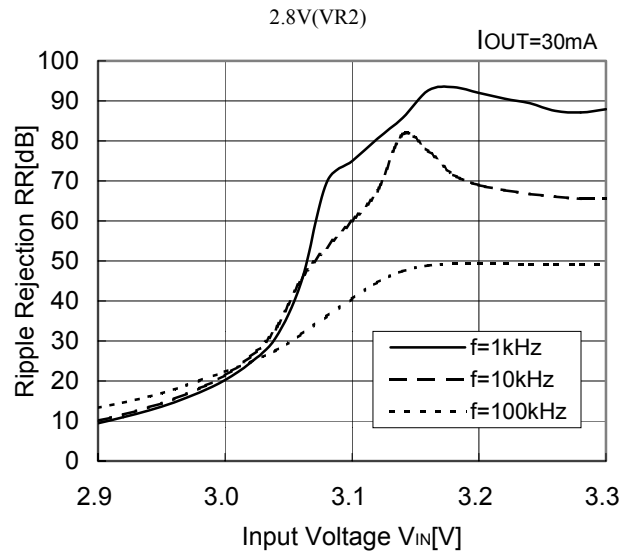
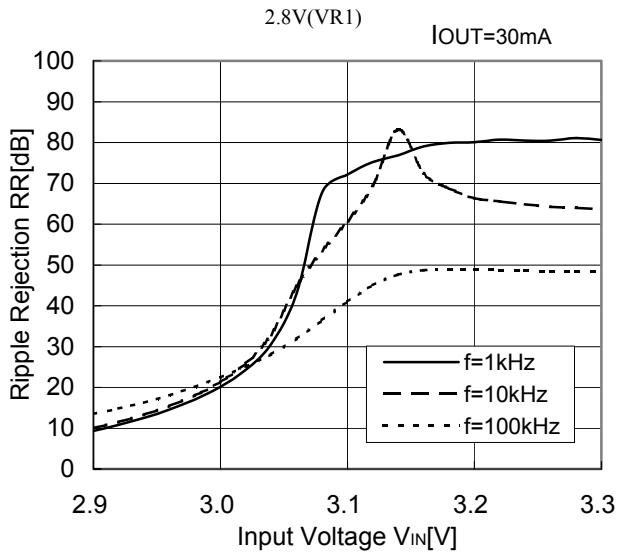
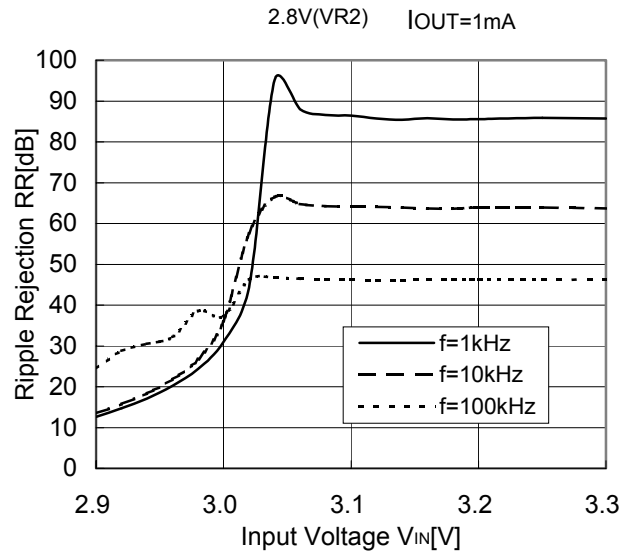
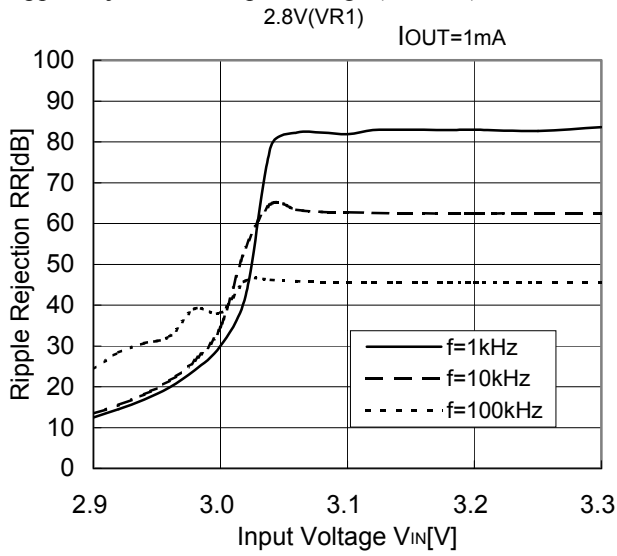

10) Input Transient Response

R5323N001X(2.8V,VR1)

$I_{OUT}=30mA$, $t_r=t_f=5\mu s$
 C_{OUT} = Ceramic $1.0\mu F$

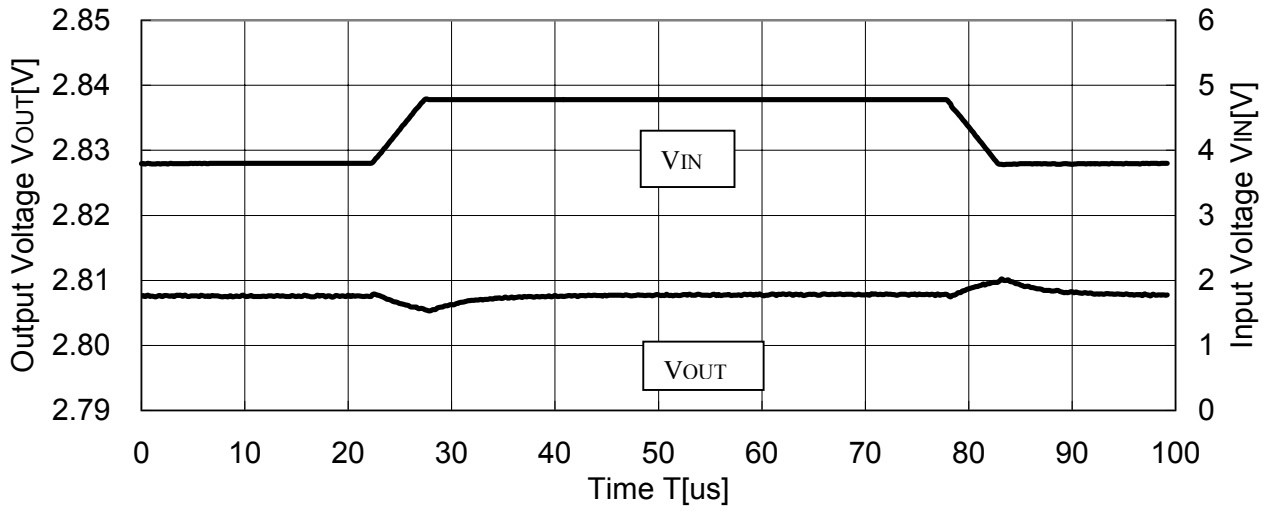

R5323N001X(2.8V,VR1)

$T_{opt}=25^{\circ}C$

C_{OUT} = Ceramic $2.2\mu F$

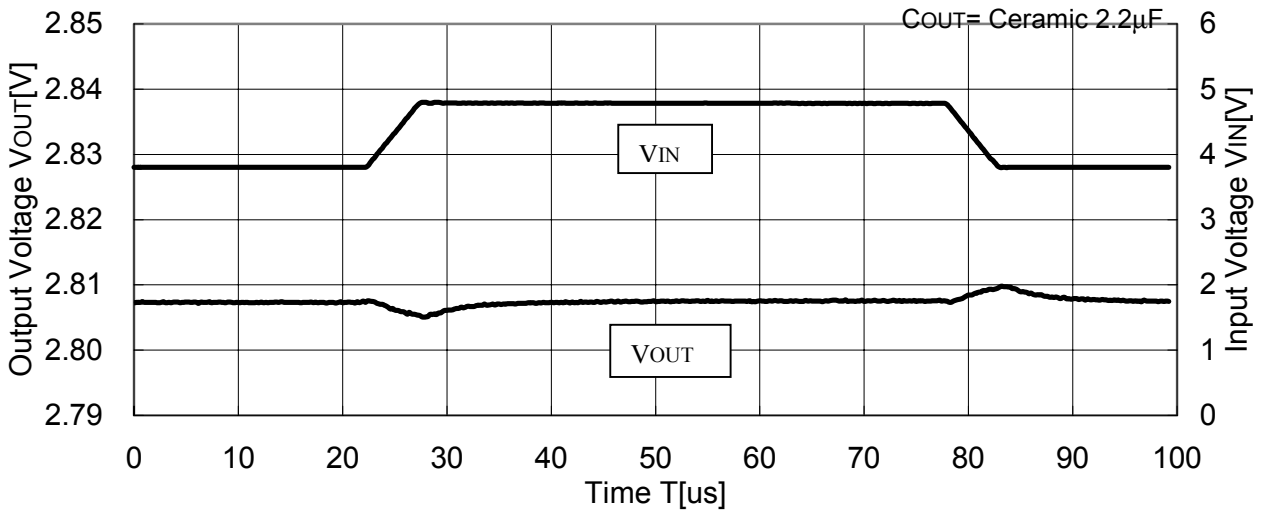

R5323N001X(2.8V,VR1)

$T_{opt}=25^{\circ}C$

C_{OUT} = Ceramic $4.4\mu F$

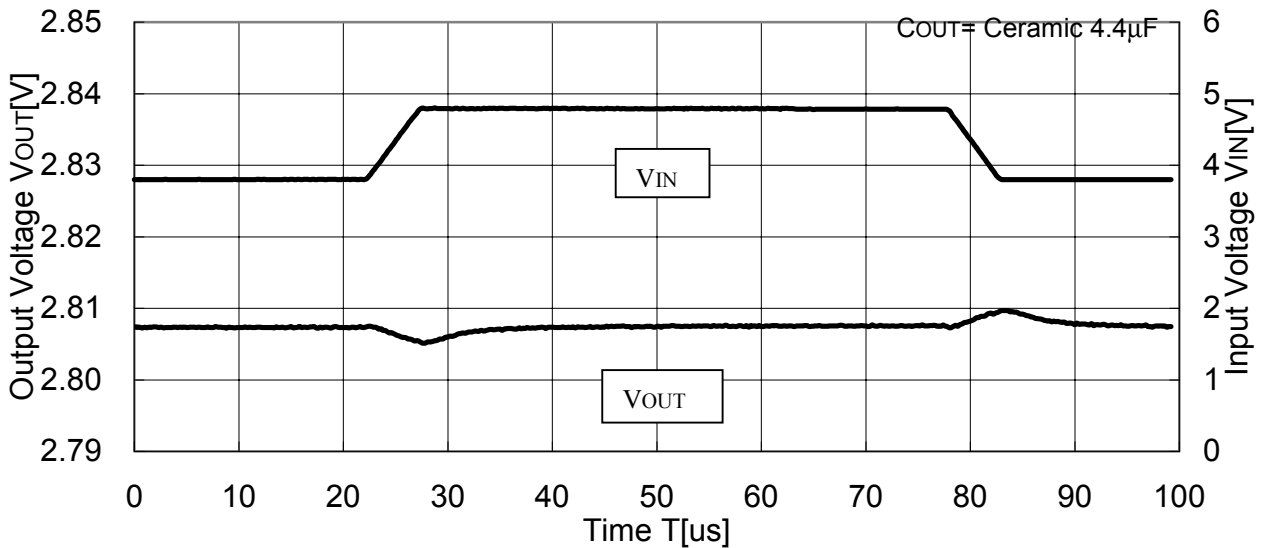

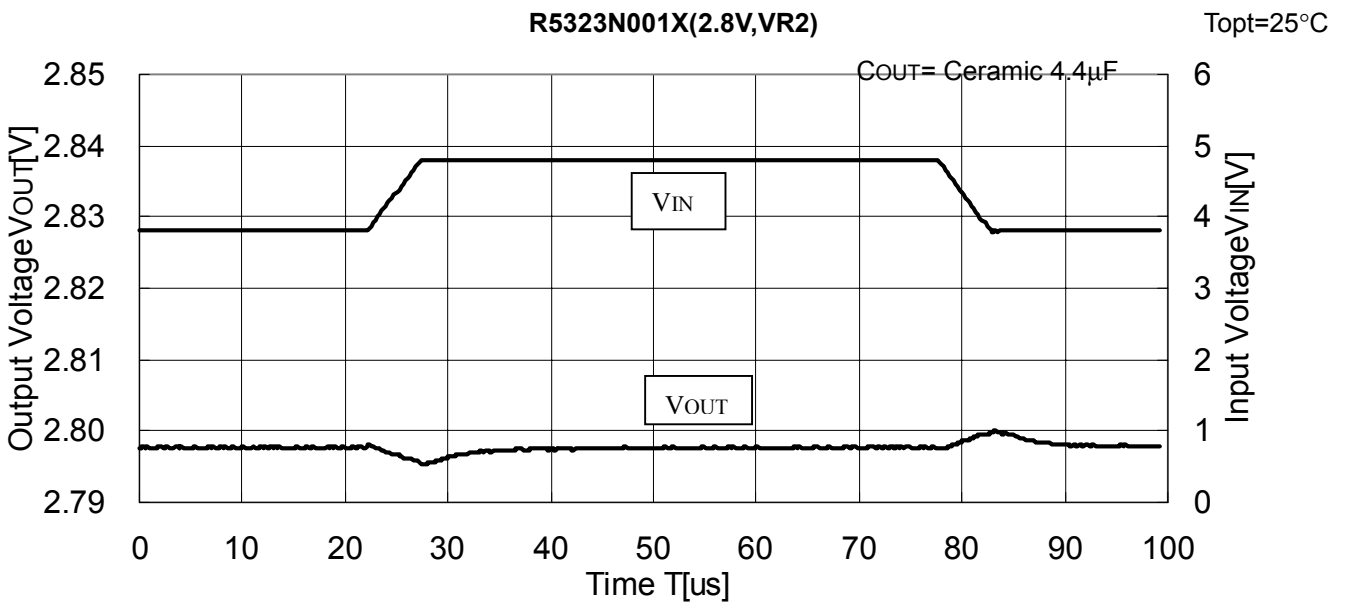
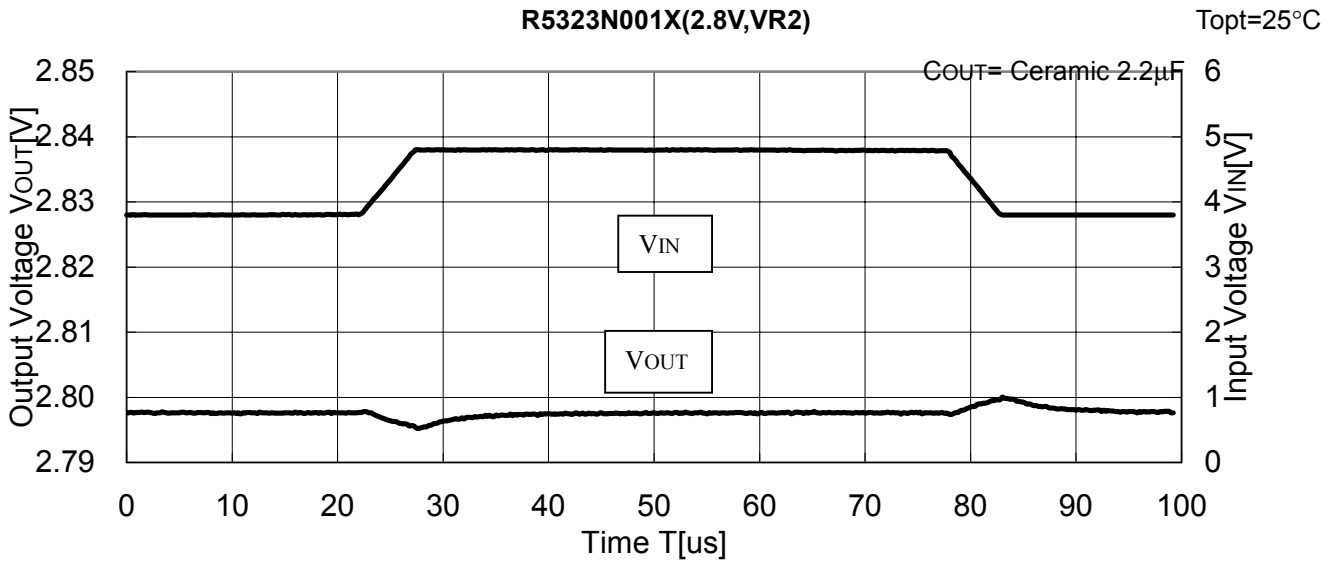
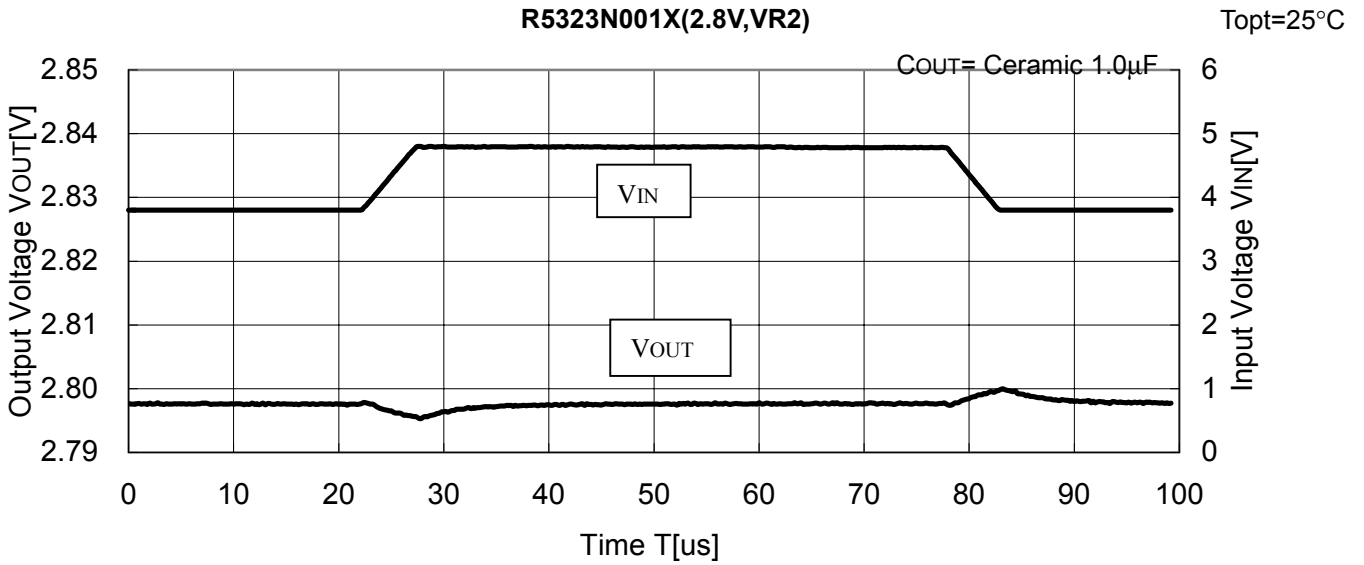

11) Load Transient Response

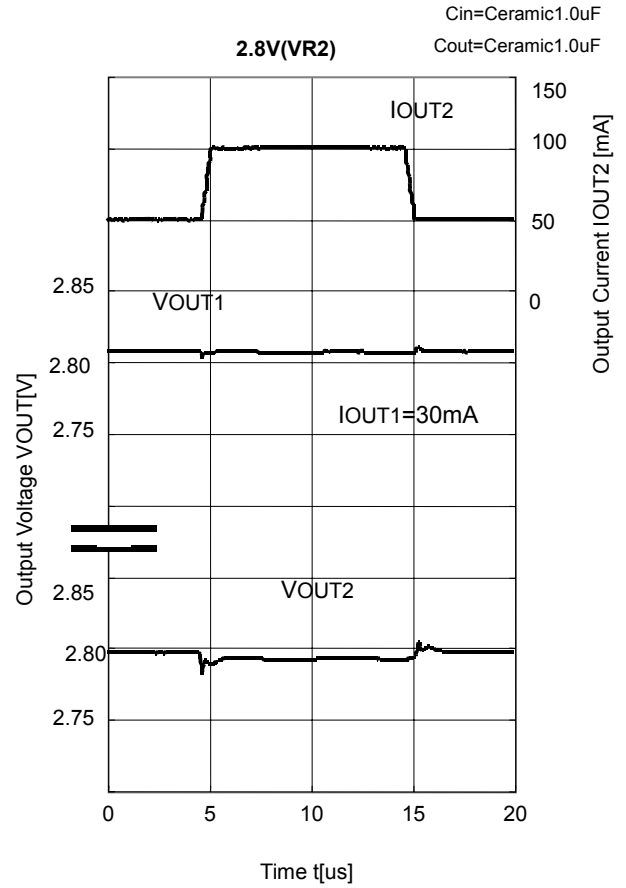
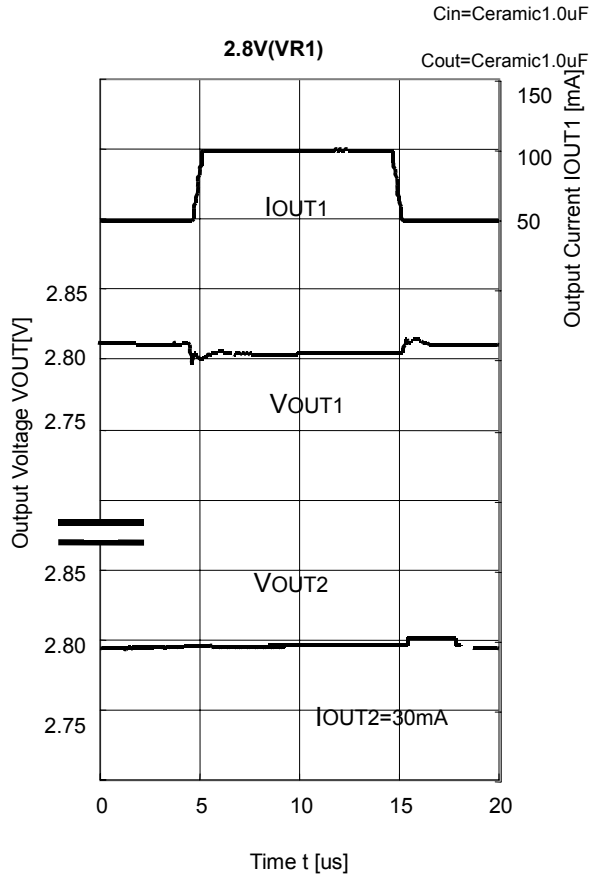

12) ESR vs. Output Current

Topt=25°C
CIN = COUT =Ceramic 1.0μF, VIN=2.5V, f=10Hz to 2MHz
(BW=30Hz)

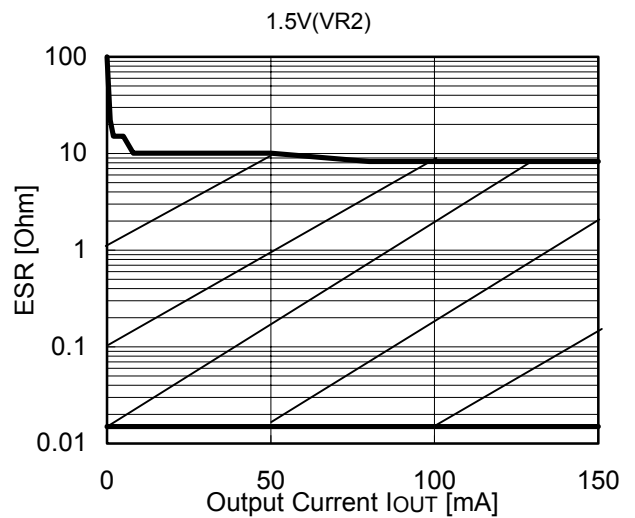
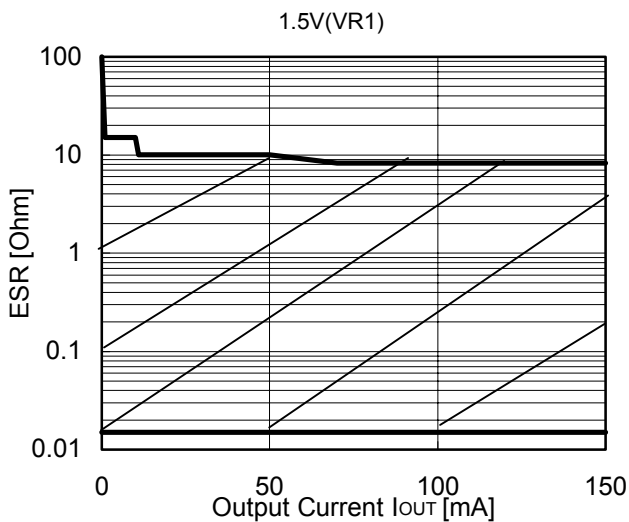

$C_{IN} = C_{OUT} = \text{Ceramic } 1.0\mu\text{F}$, $V_{IN} = 2.5\text{V}$, $f = 10\text{Hz to } 2\text{MHz}$
($BW = 30\text{Hz}$)

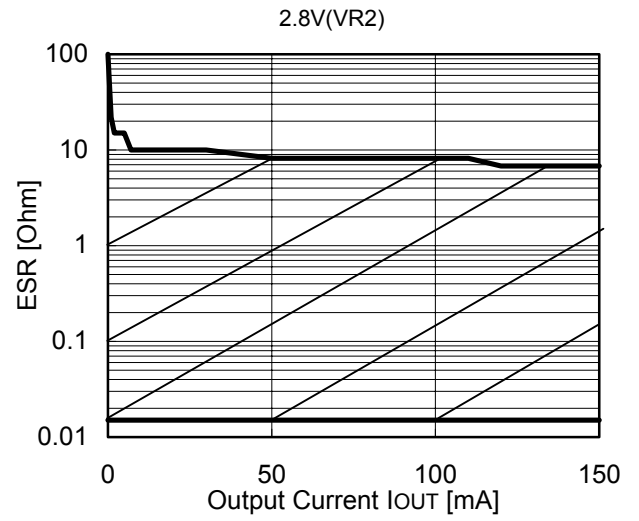
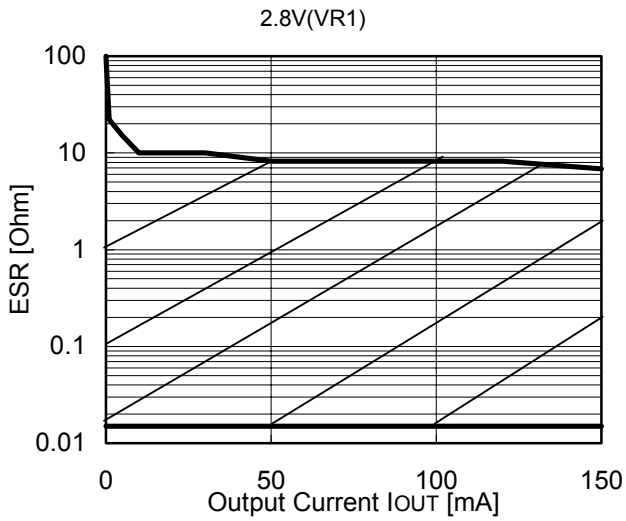

13) Minimum Operating Voltage

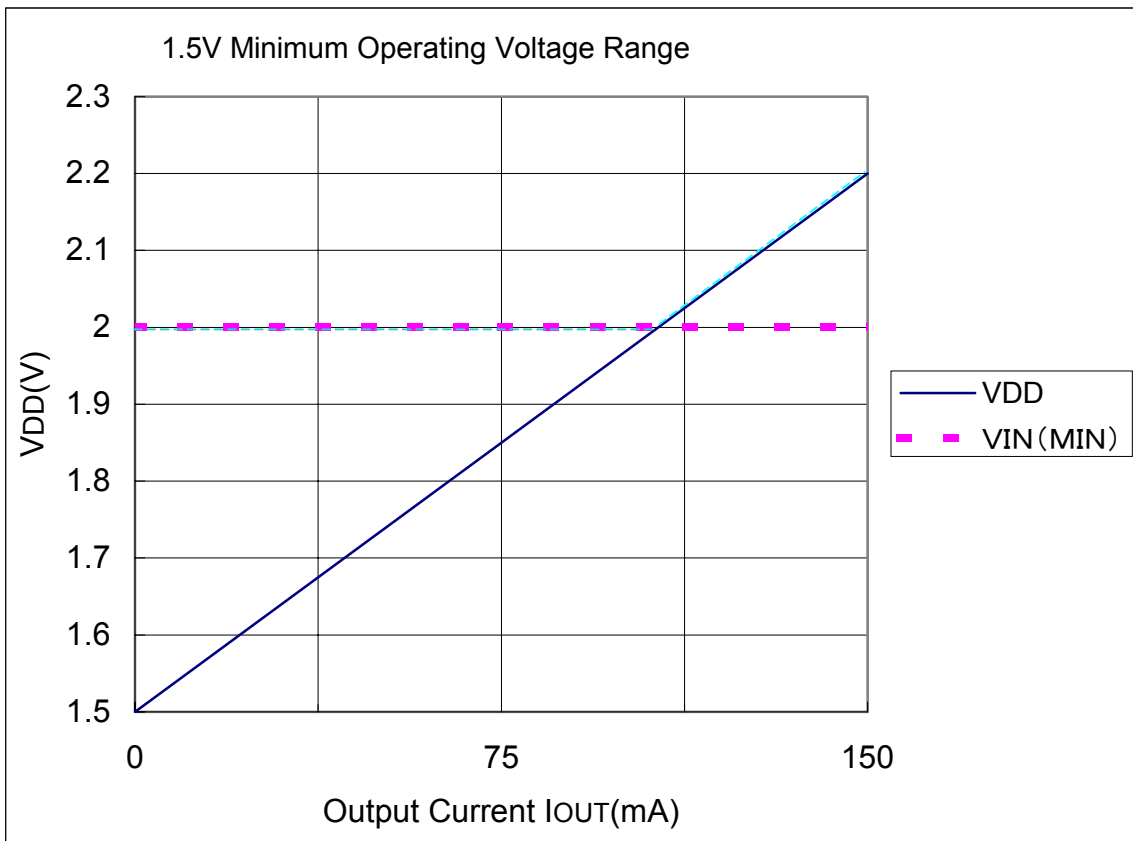

■ TECHNICAL NOTES

When using these ICs, consider the following points:

In these ICs, phase compensation is made for securing stable operation even if the load current is varied. For this purpose, be sure to use a 1.0 μ F or more capacitance C_{OUT} with good frequency characteristics and ESR (Equivalent Series Resistance) of which is in the range described as follows:

The relations between I_{OUT} (Output Current) and ESR of Output Capacitor are shown in the typical characteristics above. The conditions when the white noise level is under 40 μ V (Avg.) are marked as the hatched area in the graph.

Test these ICs with as same external components as ones to be used on the PCB.

- Make V_{DD} and GND line sufficient. When the impedance of these is high, the noise might be picked up or not work correctly.
- Connect the capacitor with a capacitance of 1 μ F or more between V_{DD} and GND as close as possible.
- Set external components, especially Output Capacitor, as close as possible to the ICs and make wiring shortest.