

Features

Regulated Converter

- 30mW max. no load power consumption
- High efficiency up to 80%
- Isolated output 3kVAC / 1 min
- SCP, OVP protection
- Wide operating temperature range: -40°C to +85°C
- Universal input 85-305VAC

RECOM AC/DC Converter

RAC03-SE/277/W

3 Watt Single Output

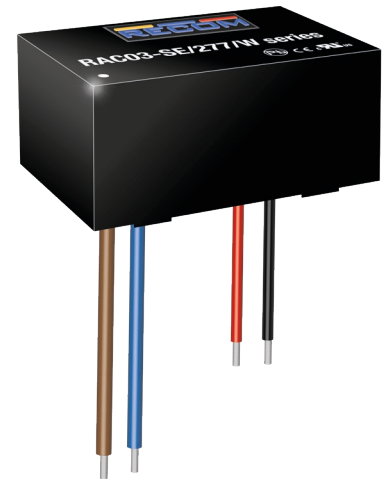

IEC/EN60950-1 certified
 CAN/CSA-22.2 No. 60950 certified
 UL60950-1 certified
 EN60335-1 certified
 EN55032 certified
 EN55024 certified
 EN55014 certified
 CB Report

Description

The ultra-compact wired RAC03-SE/277/W modules are available with output voltages of 3.3, 5, 12 and 24V, and the input-to-output isolation is 3kVAC/1min. With a standby consumption of 30mW typical, the mini power supplies are particularly suitable for energy-saving sleep mode and standby applications. Because of its compact design (height <18mm), it is a versatile solution for home automation and other similar applications. Complete with an integrated input filter, the series has enhanced EMI performance and complies with EN55032, class B. The mini power supplies are also protected against short circuit with fully automatic restart after the error has been solved. The converters are EN/UL60950-1 certified and come complete with a 3 year warranty.

Selection Guide

Part Number	nom. Input Voltage Range [VAC]	Output Voltage [VDC]	Output Current [mA]	Efficiency typ ⁽¹⁾ [%]	Max. Capacitive Load ⁽²⁾ [µF]
RAC03-3.3SE/277/W	100-277	3.3	900	71	22000
RAC03-05SE/277/W	100-277	5	600	76	7500
RAC03-12SE/277/W	100-277	12	250	78	1000
RAC03-24SE/277/W	100-277	24	125	80	200

Notes:

Note1: Efficiency is tested at 230VAC and full load at +25°C ambient

Note2: Max Cap Load is tested at nominal input and full resistive load

Model Numbering

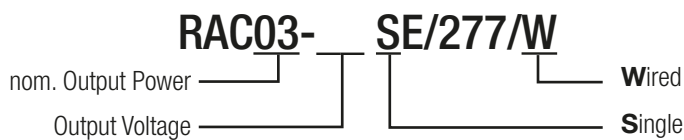

Ordering Examples:

RAC03-05SE/277/W	3 Watt	5Vout	Single Output	Wired Version
RAC03-12SE/277/W	3 Watt	12Vout	Single Output	Wired Version

Specifications (measured @ Ta= 25°C, nom. Vin (115/230VAC), full load and after warm-up unless otherwise stated)

BASIC CHARACTERISTICS

Parameter	Condition	Min.	Typ.	Max.
Input Voltage Range ⁽³⁾	nom. Vin= 230VAC	85VAC 120VDC	277VAC	305VAC 430VDC
Input Current	115VAC 230VAC		70mA 45mA	
Inrush Current	cold start at +25°C	115VAC 230VAC		15A 30A
No load Power Consumption	85-305VAC, 47-63Hz			30mW
Input Frequency Range	AC Input	47Hz		440Hz
Minimum Load			2%	
Hold-up Time	115VAC 230VAC		15ms 80ms	
Internal Operating Frequency	100% load at nominal Vin		55kHz	
Output Ripple and Noise ⁽⁴⁾			200mVp-p	

Notes:

Note3: No line derating required

Note4: Ripple and Noise is the maximum peak-to-peak voltage value measured at the output with a 20MHz bandwidth, at rated line voltage at full load. And with a 47µF low-ESR electrolytic capacitor in parallel with a 0.1µF ceramic capacitor across output

Efficiency vs. Load

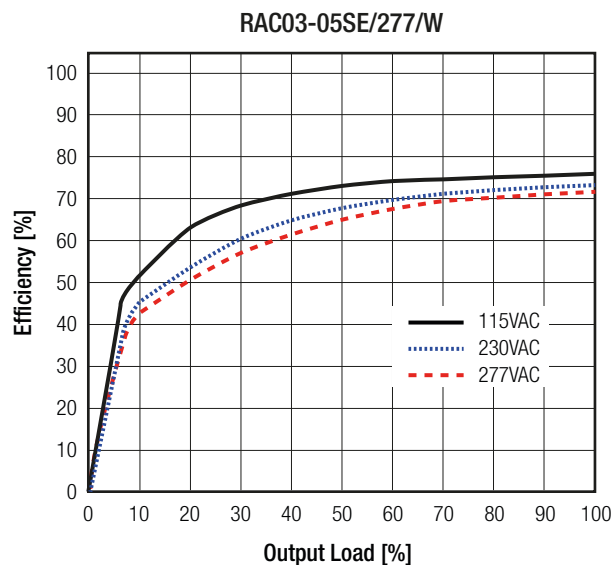

REGULATIONS

Parameter	Condition	Value
Output Voltage Tolerance ⁽⁵⁾		±6.0% max.
Line Regulation	low line to high line, full load	±1% typ. / ±1.5% max.
Load Regulation	10% to 100% load	6.0% typ.

Notes:

Note5: Includes initial voltage accuracy, thermal drift, line regulation and load regulation at rated input voltage and load conditions

Specifications (measured @ Ta= 25°C, nom. Vin (115/230VAC), full load and after warm-up unless otherwise stated)

PROTECTIONS

Parameter	Type		Value
Short Circuit Protection (SCP)	below 100mΩ		continuous, automatic recovery
Over Voltage Protection (OVP)	zener diode clamp		112% - 140%
Over Current Limit			120% - 190%
Over Voltage Category			OVCII
Isolation Voltage	I/P to O/P	tested for 1 minute	3kVAC
Isolation Resistance			1GΩ min.
Leakage Current	85-305VAC, 47-63Hz		10μA max.

Notes:

Note6: Refer to local wiring regulations if input over-current protection is also required

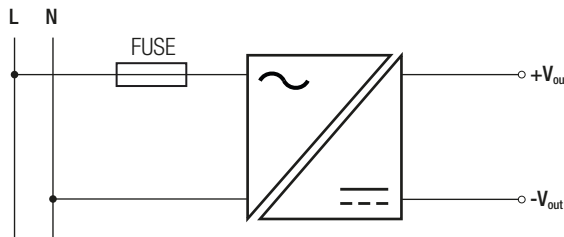

ENVIRONMENTAL

Parameter	Condition			Value
Operating Temperature Range ⁽⁷⁾	full load, 230VAC			-40°C to +75°C
	refer to derating graph			-40°C to +85°C
Maximum Case Temperature				+105°C
Thermal Impedance				10K/W typ.
Operating Humidity	non-condensing			5% - 95% RH max.
MTBF	according to MIL-HDBK-217F, G.B.	+25°C	115VAC	3503 x 10 ³ hours
			230VAC	1816 x 10 ³ hours

Notes:

Note7: At low input voltage (85-140VAC) and temperature below -25°C the RAC03-3.3SE/277/W and RAC03-05SE/277/W, will not start

Derating Graph

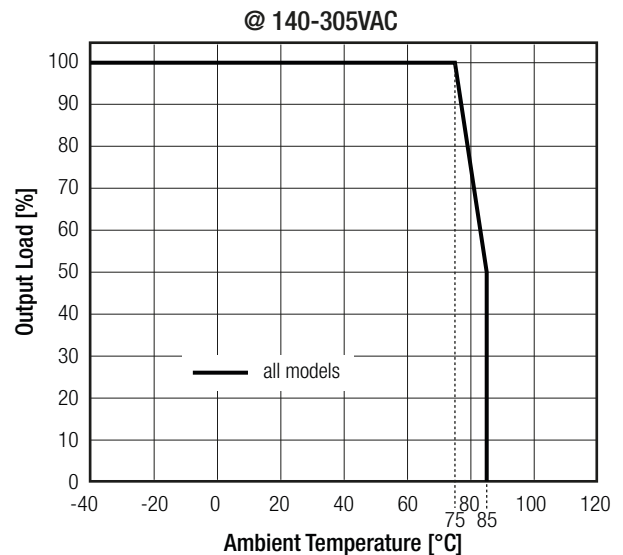
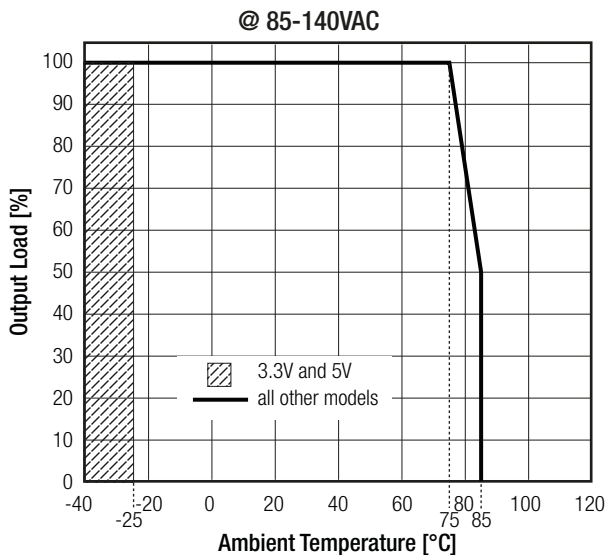

Specifications (measured @ Ta= 25°C, nom. Vin (115/230VAC), full load and after warm-up unless otherwise stated)

SAFETY AND CERTIFICATIONS

Certificate Type (Safety)	Report / File Number	Standard
Information Technology Equipment, General Requirements for Safety	L0339L26-CB-1-B4	IEC60950-1:2005 2nd Edition + A2:2013 EN60950-1:2006 + A2:2013
Information Technology Equipment, General Requirements for Safety	E224736-X1-A24-UL	UL No. 60950-1, 2nd Edition, 2014 CAN/CSA-C22.2 No. 60950-1-07, 2nd Edition, 2014
Household and similar electrical appliances, General requirements	L0339L26-B2-L	EN60335-1:2012+A11:2014
EAC Safety of Low Voltage Equipment	RU-AT.37.02367	TP TC 004/2011
RoHS2+		RoHS-2011/65/EU + AM-2015/863

EMC Compliance (Industrial)	Condition	Standard / Criterion
Electromagnetic compatibility of multimedia equipment - Emission requirements		EN55032:2015, Class B
Information technology equipment - Immunity characteristics - Limits and methods of measurement		EN55024:2010
ESD Electrostatic discharge immunity test	±8kV air, ±4kV contact	EN61000-4-2:2009, Criteria B
Radiated, radio-frequency, electromagnetic field immunity test	3V/m	EN61000-4-3:2006 + A2:2010, Criteria A
Fast Transient and Burst Immunity	AC Power Port: ±1kV	EN61000-4-4:2012, Criteria A
Power Magnetic Field Immunity	50Hz, 1A/m	EN61000-4-8:2010, Criteria A
Voltage Dips and Interruption	Voltage Dips: >95% reduction >30% reduction Interruption: >95%	EN61000-4-11:2004, Criteria A EN61000-4-11:2004, Criteria A EN61000-4-11:2004, Criteria B
Limits of Voltage Fluctuations & Flicker		EN61000-3-3:2013

EMC Compliance (Household)	Condition	Standard / Criterion
Electromagnetic compatibility of multimedia equipment – Emission Requirements		EN55014-1:2006+A2:2011
Information technology equipment - Immunity characteristics - Limits and methods of measurement		EN55014-2:2015
ESD Electrostatic discharge immunity test	±8kV air, ±4kV contact	IEC61000-4-2:2008, Criteria A
Radiated, radio-frequency, electromagnetic field immunity test	3V/m	IEC61000-4-3:2006 + A2:2010, Criteria A
Fast Transient and Burst Immunity	AC Power Port ±1.0kV DC Output ±0.5kV	IEC61000-4-4:2012, Criteria A
Surge Immunity	AC Power Port L-N ±2kV DC Output L-N ±1kV	IEC61000-4-5:2014, Criteria B
Immunity to conducted disturbances, induced by radio-frequency fields	AC Power Port 3V, DC Output 3V	IEC61000-4-6:2013, Criteria A
Voltage Dips and Interruption	Voltage Dips: >95% reduction >30% reduction Interruption: >95%	IEC61000-4-11:2004, Criteria B IEC61000-4-11:2004, Criteria C IEC61000-4-11:2004, Criteria C
Limits of Harmonic Current Emissions		EN61000-3-2:2014
Limits of Voltage Fluctuations & Flicker		EN61000-3-3:2013

DIMENSION AND PHYSICAL CHARACTERISTICS

Parameter	Type	Value
Material	case potting	black plastic, (UL94V-0) epoxy, (UL94V-0)
Dimension (LxWxH)		38.25 x 24.35 x 17.4mm
Weight		29g typ.

continued on next page

Specifications (measured @ Ta= 25°C, nom. Vin (115/230VAC), full load and after warm-up unless otherwise stated)

Dimension Drawing (mm)

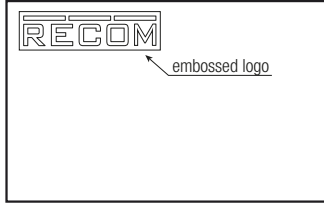
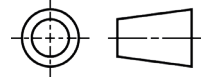

embossed logo

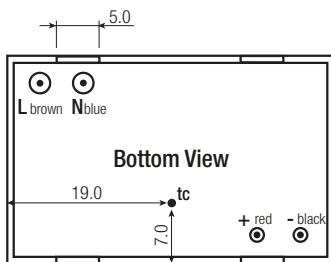
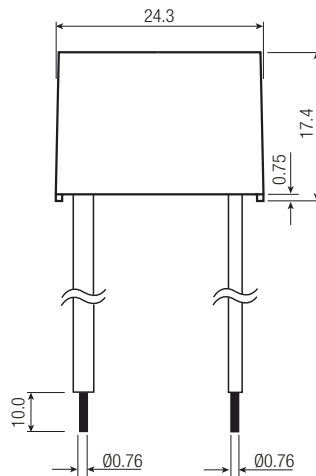
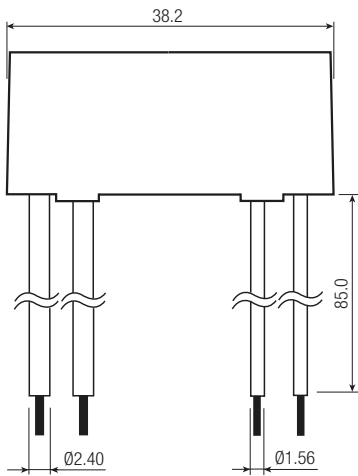

Wired Connections

Wired Color	Type	Function
1, brown	UL-1015, AWG22	VAC in (L)
2, blue	UL-1015, AWG22	VAC in (N)
3, red	UL-1430, AWG22	+Vout
4, black	UL-1430, AWG22	-Vout

tc= case temperature measuring point

Tolerance: xx.x= ±0.5mm

xx.xx= ±0.35mm

PACKAGING INFORMATION

Parameter	Type	Value
Packaging Dimension (LxWxH)	cardboard box	520.0 x 195.0 x 68.0mm
Packaging Quantity		30pcs
Storage Temperature Range		-40°C to +85°C

The product information and specifications may be subject to changes even without prior written notice. The product has been designed for various applications; its suitability lies in the responsibility of each customer. The products are not authorized for use in safety-critical applications without RECOM's explicit written consent. A safety-critical application is an application where a failure may reasonably be expected to endanger or cause loss of life, inflict bodily harm or damage property. The applicant shall indemnify and hold harmless RECOM, its affiliated companies and its representatives against any damage claims in connection with the unauthorized use of RECOM products in such safety-critical applications.