

# Features

# Regulated Converter

- 85 to 305VAC input voltage range
- 4kVAC isolation input/output
- Operating temperature: -40°C to +85°C
- Full load output power up to 75°C
- Low profile of 15.4mm height
- Household and ITE certified
- EMC compliance EN55032 class "B"



## RAC03E-K/277

**3 Watt**  
**1.45" x 0.95"**  
**Single Output**



### Description

The cost-efficient RAC03E-K/277 AC/DC converter series has an input range of nominal 100VAC to an enhanced 277VAC, delivering an uncompromising 3 watts of output power with tightly regulated outputs from 3.3V to 24VDC. These low profile, encapsulated print-mountable modules in an industry-standard pinout deliver full output power from -40°C to +75°C and are certified for operation up to +85°C air ambient with output power reduced to 1.8W. This series of AC/DC modules holds international safety certifications for industrial, domestic, ITE, and household use. With 4kVAC input to output isolation, they are suitable for worldwide applications in automation control, industry 4.0, IoT and household automation. Due to their LPS (Limited Power Source) and reinforced class II installation rating for floating outputs and their significantly wide margin to class B EMC compliance without external components, these are the easiest to use, versatile power modules in the industry.

### Selection Guide

Part Number	Input Voltage Range [VAC]	Output Voltage [VDC]	Output Current [mA]	Efficiency typ. <sup>(1)</sup> [%]
RAC03E-3.3SK/277	85-305	3.3	900	68
RAC03E-05SK/277	85-305	5	600	73
RAC03E-12SK/277	85-305	12	250	75
RAC03E-15SK/277	85-305	15	200	77
RAC03E-24SK/277	85-305	24	125	79

#### Notes:

Note1: Efficiency is tested at nominal input and full load at +25°C ambient

### Model Numbering



### Specifications (measured @ Ta= 25°C, nom. Vin, full load and after warm-up unless otherwise stated)

BASIC CHARACTERISTICS					
Parameter	Condition		Min.	Typ.	Max.
Nominal Input Voltage	50/60Hz		100VAC		277VAC
Input Voltage Range <sup>(2,3)</sup>	47-63Hz DC		85VAC 120VDC	277VAC	305VAC 430VDC
Input Current	115VAC 230VAC 277VAC				70mA 50mA 40mA
Inrush Current	cold start at 25°C	115VAC 230VAC 277VAC			10A 20A 25A
No load Power Consumption					75mW
ErP Standby Mode Conformity (Maximum output power available for stated maximum input power)	Module Input Power= 0.5W 1.0W				0.32W 0.68W
<b>Notes:</b>					
Note2: The products were submitted for safety files at AC-Input operation (90-305VAC)					
Note3: Refer to " <b>Derating Graph</b> <sup>(7)</sup> "					
continued on next page					

UL/IEC/EN62368-1 certified  
 CAN/CSA C22.2 No. 62368-1 certified  
 EN60335-1 (pending)  
 EN62233 (pending)  
 IEC/EN61558-1/2-16 (pending)  
 EN55032/EN55035 compliant  
 CB Report

**Specifications** (measured @ Ta= 25°C, nom. Vin, full load and after warm-up unless otherwise stated)

### BASIC CHARACTERISTICS

Parameter	Condition		Min.	Typ.	Max.
Input Frequency Range	AC Input		47Hz		63Hz
Minimum Load			0%		
Power Factor	115VAC		0.55		
	230VAC		0.45		
	277VAC		0.40		
Start-up Time				15ms	
Rise Time				10ms	
Hold-up Time	115VAC			15ms	
	230VAC			80ms	
	277VAC			120ms	
Internal Operating Frequency	100% load at nominal Vin				132kHz
Output Ripple and Noise <sup>(4)</sup>	20MHz BW	3.3, 5Vout others			120mVp-p 1% of Vout

**Notes:**

Note4: Measurements are made with a 0.1µF MLCC & 10µF E-cap in parallel across output. (low ESR)

**Efficiency vs. Load**

**RAC03E-3.3SK/277**

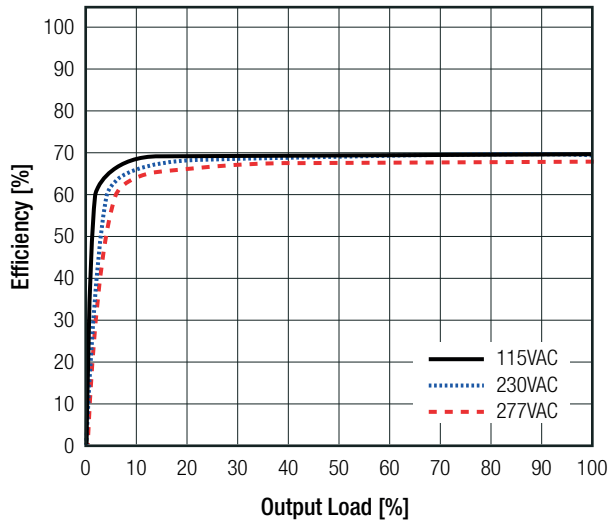

**RAC03E-05SK/277**

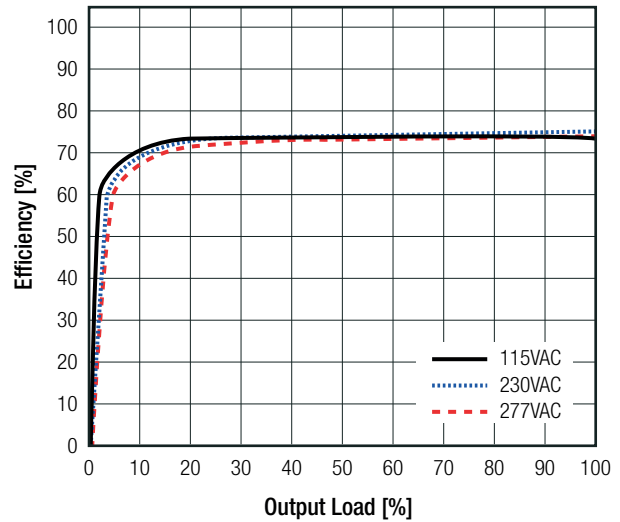

**RAC03E-12SK/277 / RAC03E-24SK/277**

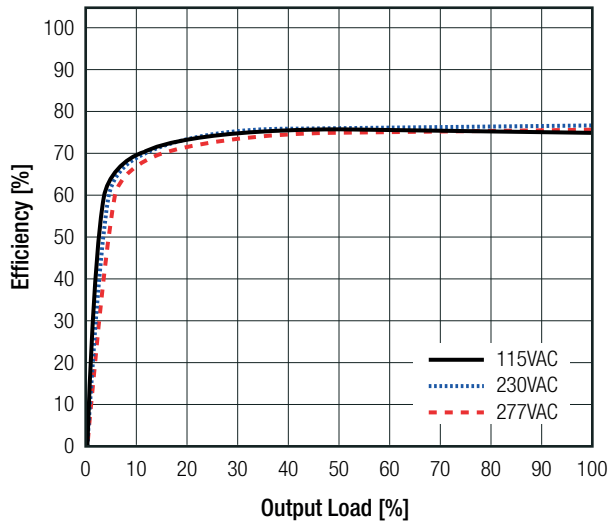

**RAC03E-15SK/277**

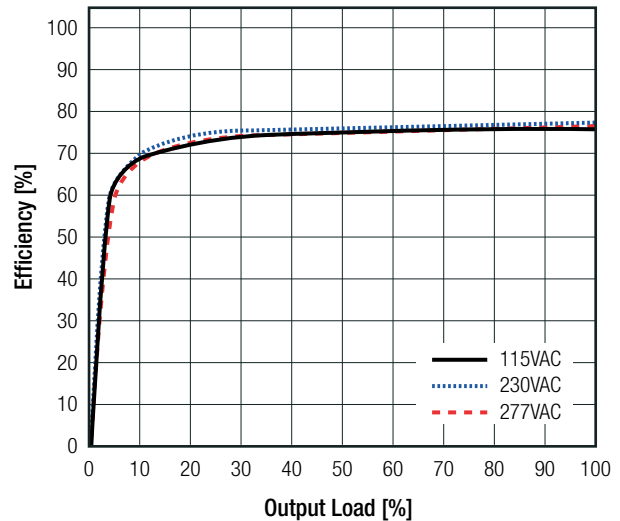

continued on next page

**Specifications** (measured @ Ta= 25°C, nom. Vin, full load and after warm-up unless otherwise stated)

**REGULATIONS**

Parameter	Condition	Value
Output Accuracy		±1.0% max.
Line Regulation	low line to high line, full load	±0.5% typ.
Load Regulation <sup>(5)</sup>	10% to 100% load	0.5% typ.
Transient Response	10% load step change recovery time	6.0% max. 350µs typ.

**Notes:**

Note5: Operation below 10% load will not harm the converter, but specifications may not be met

**Deviation vs. Load**

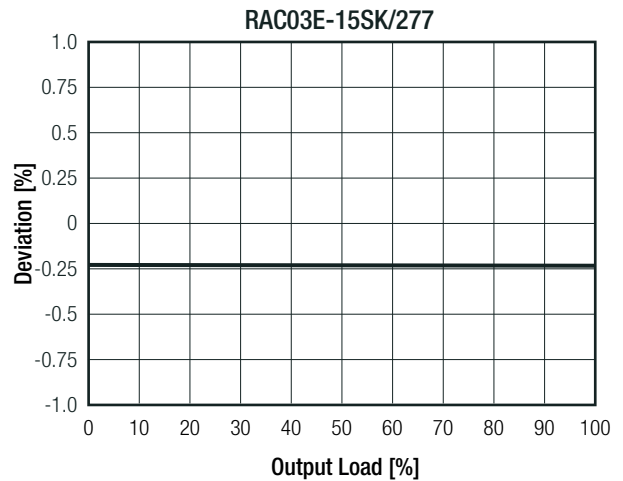
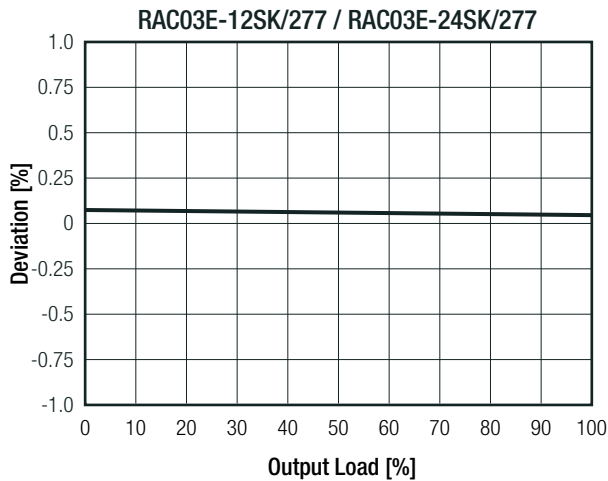
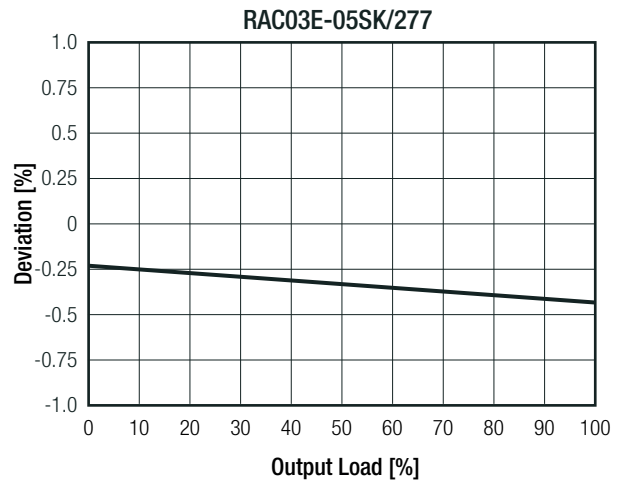
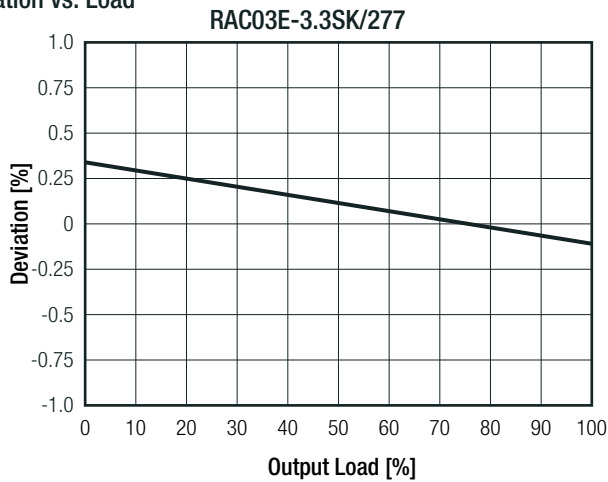

**PROTECTIONS**

Parameter	Type	Value
Input Fuse	internal	fusible resistor
Short Circuit Protection (SCP)		Hiccup mode, auto recovery
Over Voltage Protection (OVP)		120% - 260%, hiccup mode
Over Current Protection (OCP)		120% - 300%, hiccup mode
Over Voltage Category (OVC)		OVCII
Isolation Voltage <sup>(6)</sup>	I/P to O/P	1 minute 4kVAC

**Notes:**

Note6: For repeat Hi-Pot testing, reduce the time and/or the test voltage

continued on next page

**Specifications** (measured @ Ta= 25°C, nom. Vin, full load and after warm-up unless otherwise stated)

**PROTECTIONS**

Parameter	Condition	Value
Isolation Resistance	I/P to O/P, Isolation Voltage 500VDC	1GΩ min.
Isolation Capacitance	I/P to O/P, 100KHz/0.1V	100pF max.
Leakage Current	@ 277VAC	0.25mA max.
Insulation Grade		reinforced

**ENVIRONMENTAL**

Parameter	Condition		Value
Operating Temperature Range	@ natural convection 0.1m/s	refer to "Derating Graph (7)"	-40°C to +85°C
Maximum Case Temperature			+95°C
Temperature Coefficient			±0.03%/K
Operating Altitude			2000m
Operating Humidity	non-condensing		20% - 90% RH max.
Pollution Degree			PD2
Vibration			10-500Hz, 2G10min./1cycle, period 60min. each along x,y,z axes
MTBF	according to MIL-HDBK-217F, G.B.	+25°C +40°C	2260 x 10 <sup>3</sup> hours 2040 x 10 <sup>3</sup> hours
Design Lifetime	230VAC/60Hz and full load +50°C		>30 x 10 <sup>3</sup> hours

**Derating Graph (7)**

(@ Chamber and natural convection 0.1 m/s)

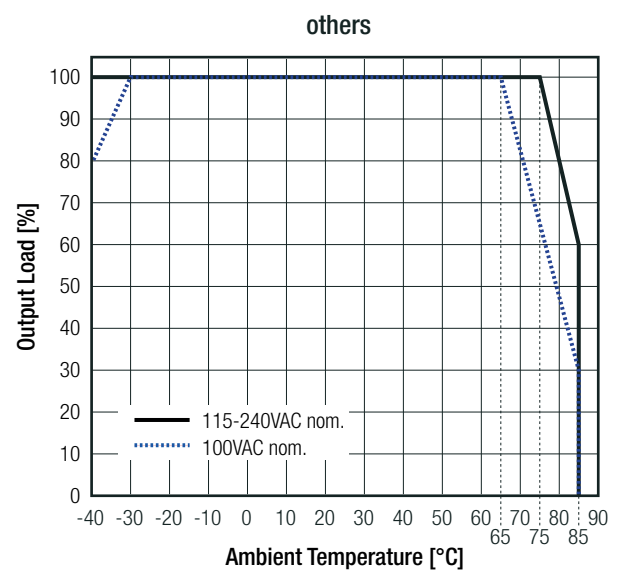
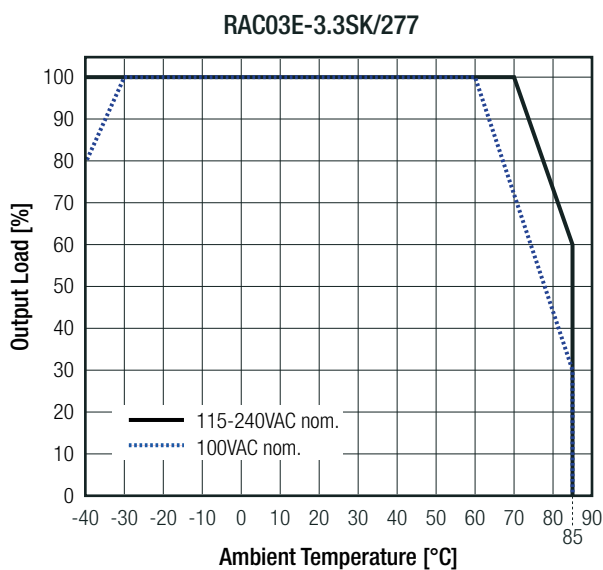

**Notes:**

Note7: Output power derating for Line-input of less than 90VAC (derate linearly from 100% at 90VAC to 85% at 85VAC)

**Specifications** (measured @ Ta= 25°C, nom. Vin, full load and after warm-up unless otherwise stated)

### SAFETY AND CERTIFICATION

Certificate Type (Safety)	Report Number	Standard
Audio/Video, information and communication technology equipment - Part 1: Safety requirements	E491408-A6014-UL	UL62368-1:2019 3rd Edition CAN/CSA-C22.2 No. 62368-1:2019
Audio/Video, information and communication technology equipment - Safety requirements (CB Scheme)	200703001-1	IEC62368-1:2018 3rd Edition
Audio/Video, information and communication technology equipment - Safety requirements (LVD)		EN IEC 62368-1:2020+A11:2020
Household and similar electrical appliances – Safety – Part 1: General requirements (LVD)	(pending)	EN60335-1:2012 + A11:2014
Measurement methods for electromagnetic fields of household appliances and similar apparatus with regard to human exposure	(pending)	EN62233:2008
Safety of power transformers, power supplies, reactors and similar products for supply voltages up to 1100 V (CB Scheme)	(pending)	IEC61558-1:2005 2nd Edition + A1:2009
Safety of power transformers, power supplies, reactors and similar products for supply voltages up to 1100 V	(pending)	EN61558-1:2005 + A1:2009
Safety of power transformers, power supplies, reactors and similar products for supply voltages up to 1100 V Part 2: Particular requirements (CB Scheme)	(pending)	IEC61558-2-16:2009 1st Edition + A1:2013
Safety of power transformers, power supplies, reactors and similar products for supply voltages up to 1100 V Part 2: Particular requirements	(pending)	EN61558-2-16:2009 + A1:2013
RoHS2		RoHS 2011/65/EU + AM2015/863

EMC Compliance (Industrial)	Condition	Standard / Criterion
Electromagnetic compatibility of multimedia equipment – Emission Requirements		EN55032:2015, Class B
Electromagnetic compatibility of multimedia equipment – Immunity requirements		EN55035:2017
ESD Electrostatic discharge immunity test	Air: ±2, 4 ,8kV; Contact: ±4kV	IEC61000-4-2:2008 , Criteria B EN61000-4-2:2009, Criteria B
Radiated, radio-frequency, electromagnetic field immunity test	3V/m: 80-1000MHz, 1800MHz, 2600MHz, 3500MHz, 5000MHz	IEC/EN61000-4-3:2006 + A2:2010, Criteria A
Fast Transient and Burst Immunity	AC Port: ±1kV	IEC/EN61000-4-4:2012, Criteria B
Surge Immunity	AC Port: ±1kV	IEC/EN61000-4-5:2014, Criteria B
Immunity to conducted disturbances, induced by radio-frequency fields	3Vrms: 0.15-10MHz 3-1Vrms: 10-30MHz 1Vrms: 30-80MHz	IEC61000-4-6:2013/EN6100-4-6:2014, Criteria A IEC61000-4-6:2013/EN6100-4-6:2014, Criteria A IEC61000-4-6:2013/EN6100-4-6:2014, Criteria A
Power Magnetic Field Immunity		IEC61000-4-8:2009 EN61000-4-8:2010
Voltage Dips and Interruptions		IEC/EN61004-11:2004
Limits of Harmonic Current Emissions		IEC/EN61000-3-2:2019
Limits of Voltage Fluctuations & Flicker	Clause 5	EN61000-3-3:2013+A1
Limitations on the amount of electromagnetic interference allowed from digital and electronic devices		FCC 47 CFR Part 15 Subpart B, Class B

### DIMENSION AND PHYSICAL CHARACTERISTICS

Parameter	Type	Value
Material	case/baseplate potting PCB	black plastic (UL94V-0) silicone (UL94V-0) FR4 (UL94V-0)
Dimension (LxWxH)		37.0 x 24.0 x 15.4mm
Weight		22.8g typ.

continued on next page

Specifications (measured @ Ta= 25°C, nom. Vin, full load and after warm-up unless otherwise stated)

Dimension Drawing (mm)

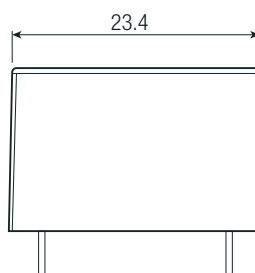
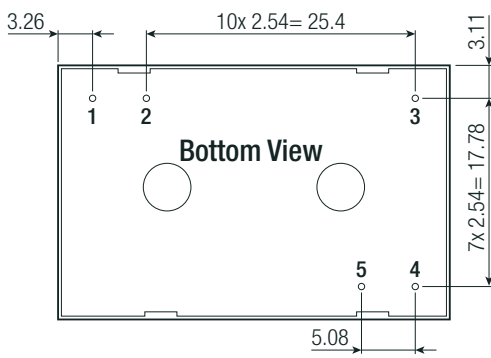
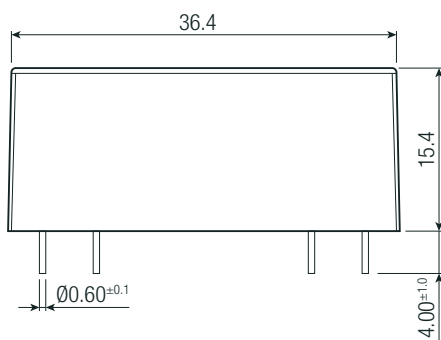
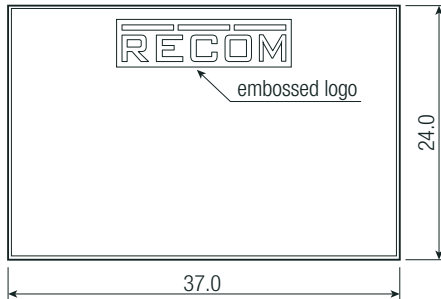
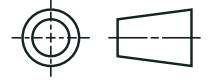

Recommended Footprint Details

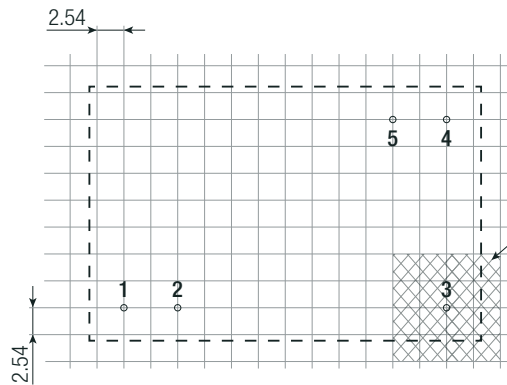

Pinning Information

Pin #	Single
1	VAC in (L)
2	VAC in (N)
3	NC
4	-Vout
5	+Vout

NC= no connection

General tolerances according to ISO 2768-m (table for reference only)

Dimension range	Tolerances
0.5 - 6 mm	±0.1 mm
6 - 30 mm	±0.2 mm
30 - 120 mm	±0.3 mm
120 - 400 mm	±0.5 mm

PACKAGING INFORMATION

Parameter	Type	Value
Packaging Dimension (LxWxH)	tube	490.0 x 26.6 x 25.3mm
Packaging Quantity		12pcs
Storage Temperature Range		-40°C to +85°C
Storage Humidity	non-condensing	95% RH max.

The product information and specifications may be subject to changes even without prior written notice. The product has been designed for various applications; its suitability lies in the responsibility of each customer. The products are not authorized for use in safety-critical applications without RECOM's explicit written consent. A safety-critical application is an application where a failure may reasonably be expected to endanger or cause loss of life, inflict bodily harm or damage property. The applicant shall indemnify and hold harmless RECOM, its affiliated companies and its representatives against any damage claims in connection with the unauthorized use of RECOM products in such safety-critical applications.