

Features

Regulated Converters

- Universal Input 80-305VAC
- High efficiency up to 79%
- Isolated Output 3.75kVAC / 1 min
- Short Circuit Protection
- Maximum No Load <50mW, Maximum Input Power <0.5W @0.3W Output Power
- Meet EN55022 Class B
- Fixed Output Voltage

Selection Guide

Part Number	Input Voltage (VAC)	Output Voltage (VDC)	Output Current (mA)	Efficiency (Typ.) (%)	Max. Capacitive Load (1+2)
RAC04-3.3SC/277	80-305	3.3	1200	72	10000µF
RAC04-05SC/277	80-305	5	800	75	7200µF
RAC04-12SC/277	80-305	12	333	78	1000µF
RAC04-15SC/277	80-305	15	267	79	820µF
RAC04-24SC/277	80-305	24	167	79	220µF
RAC04-0512DC/277	80-305	5/12	720/33	75	4700/100µF
RAC04-05DC/277	80-305	±5	±400	76	±3300µF
RAC04-12DC/277	80-305	±12	±166	78	±680µF

Specifications (measured at TA 25°C, full load after warm-up)

Input Voltage Range (with Derating)	80-305VAC or 113-430VDC	
Input Frequency	47-440Hz	
Input Current (Full Load)	115VAC/230VAC	98mA / 64mA max.
Inrush Current	115VAC/230VAC	15A / 30A max.
No Load Power Consumption	115VAC/230VAC/277VAC / 50/60Hz	50mW max.
Output Voltage Accuracy (Full Load)	Single Outputs	±2% typ.
	Dual Outputs	±2% typ.
Line Voltage Regulation (90-305VAC)	5V/12V	±2% / ±10% typ.
	Single Outputs	±0.2% typ.
	Dual Outputs	±0.2% typ.
Load Voltage Regulation	5V/12V	±0.2% / ±1% typ.
	3.3V/5V Output	±1% typ.
(5V Minimum Load 5% @12V Full Load)	All Others	0.5% typ.
	5V/12V	±1% / ±5% typ.
Output Ripple&Noise	200mVp-p typ.	
(measured @ 20MHz BW with 0.1µF & 47µF parallel capacitor)		
Switching Frequency (Full Load)	67kHz	
Hold-Up Time (@115VAC)	15ms min.	
Minimum Load	5V/12V	5% / 0% typ.
	All Others	0%
Isolation Voltage	Input-Output	3.75kVAC / 1minute
Leakage Current	277VAC / 50Hz	0.25mA max.
Isolation Resistance	100M Ω min.	
Short Circuit Protection	Auto Recovery	
Operating Temperature Range	-25°C to +65°C (without Derating)	
(Natural Convection, with Derating)	-25°C to +80°C (with Derating)	
Storage Temperature Range	-40°C to +100°C	
Case Material	UL94V-0 Black Plastic	

continued on next page

POWERLINE

AC/DC-Converter

with 3 year Warranty

RECOM

4 Watt Single / Dual Output



EN-60950-1 Certified

UL-60950-1 Certified

RAC04-C/277

Derating Graph (Ambient Temperature)

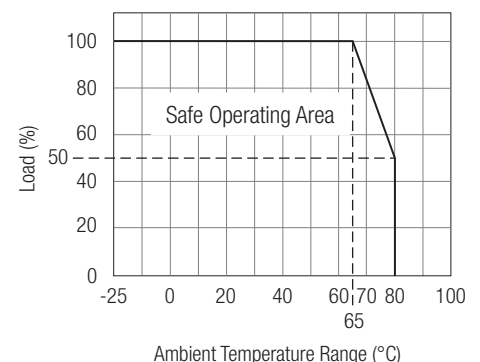

Refer to Application Notes

Specifications (measured at TA 25°C, full load after warm-up)

Relative Humidity	Non Condensing	95% RH max.
Package Weight		31.5g typ.
Physical Dimenstions	(LxWxH)	36.7x27.2x17.1 mm
EMC	Conducted and Radiated	EN55022 Class B
	Noise Immunity	EN55024
MTBF (+25°C)	MIL-HDBK-217F	500 x 10 ³ hours
Certification	UL General Safety (Report: E224736-A18-UL) EN General Safety (Report: SPCLVD1310079-1) CB General Safety (Report: 131055-1CB-M1)	UL60950-1, 2nd Edition EN60950-1, 2006 IEC 60950-1: 2005; 2nd Edition

Notes:

Note1: Measured @ 230VAC / 50Hz / Ta=25°C with constant resistant mode at full load.

Note2: If used @ 115VAC / 60Hz with full load, max. capacitive load is less, please contace RECOM for detailed information.

Specifications (measured at TA 25°C, full load after warm-up)

RAC04-3.3SC/277

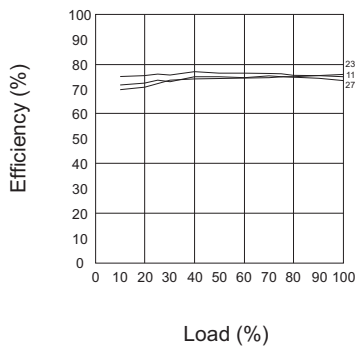

RAC04-05SC/277

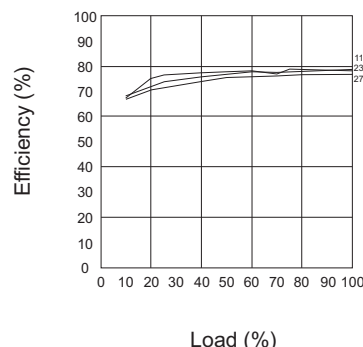

RAC04-12SC/277

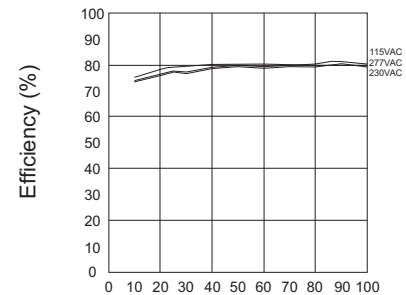

RAC04-15SC/277

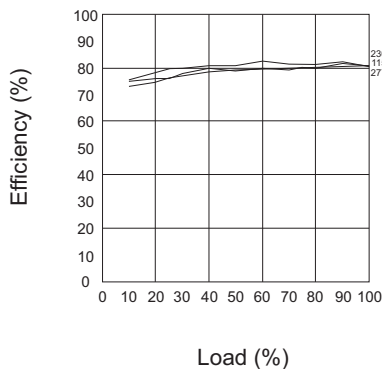

RAC04-05DC/277

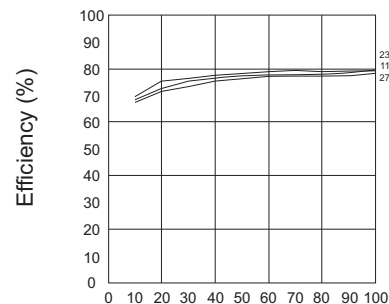

RAC04-12DC/277

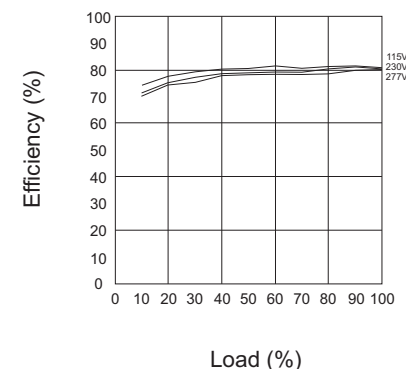

RAC04-0512DC/277

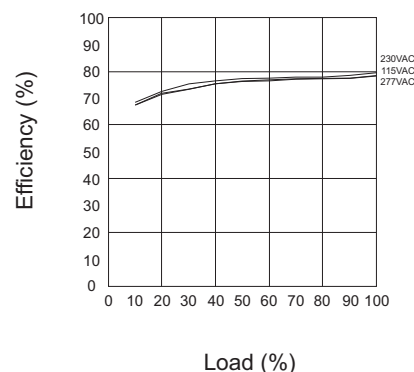

RAC04-c/277

Specifications (measured at TA 25°C, full load after warm-up)

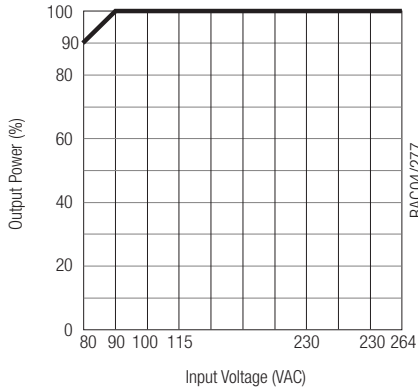

Application Note:

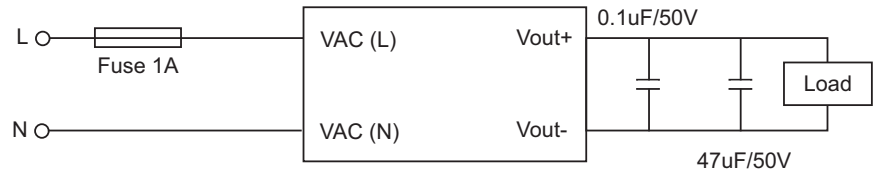

1. Recommended external input fuse 1A/slow blow type.
2. To measure the output ripple & noise short runs by 0.1uF/50V&47uF/50V @20MHz, nominal input and full load. Please see as above.
3. That Pin 7 is NC but need 4mm minimum clearance to ground for safety.

Package Style and Pinning

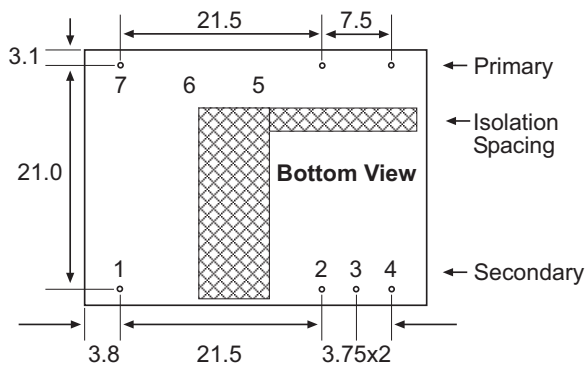
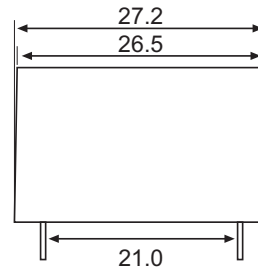
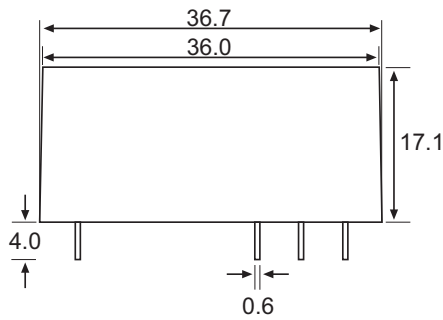

Pin Connections

Pin #	Single Out	Dual Output	Dual Output
1	No Pin	No Pin	No Pin
2	+VDC out	+Vout	+Vout
3	-VDC out	Com	Com
4	NC	-Vout	+12V
5	VAC in (L)	VAC in (L)	VAC in (L)
6	VAC in (N)	VAC in (N)	VAC in (N)
7	NC	NC	NC

NC = No Connection
xx.x = ±0.5mm
xx.xx = ±0.25mm