

# Data Sheet for SAW Components

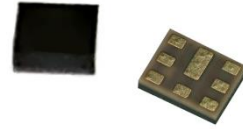

Band2

Duplexer

---

Product ID: RBD1960G3G

Date: May. 9, 2023

Revision: 1.0

---

## Features

- ◆ Package Size: 1.6 x 1.2 x 0.6max mm
- ◆ Single-Ended Input and Output
- ◆ Terminating Impedance: 50  $\Omega$
- ◆ Moisture Sensitivity Level 3
- ◆ ESD Sensitive Device
- ◆ TC-SAW
- ◆ Low Insertion Loss

**Electrical Specifications Band2 Duplexer**

Temperature Range for Specification: -30 to +85 °C

Tx to Ant	Min.	Typ.	Max.	Unit
Insertion Loss				
1850.25 - 1909.75 MHz	-	1.4	2.5	dB
Pass Band Ripple				
1850.25 - 1909.75 MHz	-	0.4	1.1	dB* <sup>1</sup>
VSWR Tx				
1850.25 - 1909.75 MHz	-	1.4	1.9	-
VSWR Ant				
1850.25 - 1909.75 MHz	-	1.3	1.9	-
Absolute Attenuation				
10 - 960 MHz	35	40	-	dB
1164 - 1189 MHz	30	36	-	dB
1559 - 1606 MHz	30	34	-	dB
1930.25 - 1989.75 MHz	40	51	-	dB
2010 - 2025 MHz	36	45	-	dB
2110 - 2200 MHz	30	36	-	dB
2300 - 2370 MHz	25	33	-	dB
2400 - 2500 MHz	30	42	-	dB
3700 - 3820 MHz	17	33	-	dB
4900 - 5850 MHz	3	28	-	dB
5254 - 8500 MHz	3	25	-	dB

\*1: Over any 5 MHz in band

**Electrical Specifications Band2 Duplexer**

Temperature Range for Specification: -30 to +85 °C

Ant to Rx	Min.	Typ.	Max.	Unit
Insertion Loss				
1930.25 - 1989.75 MHz	-	1.9	3.0	dB
Pass Band Ripple				
1930.25 - 1989.75 MHz	-	0.5	1.2	dB <sup>*1</sup>
VSWR Rx				
1930.25 - 1989.75 MHz	-	1.4	2.0	-
VSWR Ant				
1930.25 - 1989.75 MHz	-	1.4	2.0	-
Absolute Attenuation				
10 - 915 MHz	45	48	-	dB
1427 - 1850 MHz	35	40	-	dB
1850.25 - 1909.75 MHz	45	55	-	dB
2050 - 2075 MHz	35	41	-	dB
2300 - 2690 MHz	30	43	-	dB
2400 - 2500 MHz	30	44	-	dB
3860 - 3980 MHz	35	59	-	dB
4900 - 5970 MHz	28	50	-	dB
7720 - 7960 MHz	10	44	-	dB

\*1: Over any 5 MHz in band

**Electrical Specifications    Band2 Duplexer**

Temperature Range for Specification:    -30 to +85 °C

Tx to Rx	Min.	Typ.	Max.	Unit
Isolation				
1850.25 - 1909.75 MHz	54	60	-	dB
1932.5 - 1987.5 MHz	50	53	-	dB <sub>INT</sub> <sup>*2</sup>

\*2: Integrated |S32| over the center 4.5 MHz CH BW and converting to dB value



### Maximum Ratings

Item	Rating	Condition / Remark
Storage Temperature	-40 to +85 °C	
DC Voltage	5 V	+25 °C
Input power	+30 dBm	LTE , +55 °C , 3000 h

### Recommended Operating Conditions

Item	Rating	Condition / Remark
Operating Temperature, T <sub>CASE</sub>	-30 to +85 °C	

Package Information

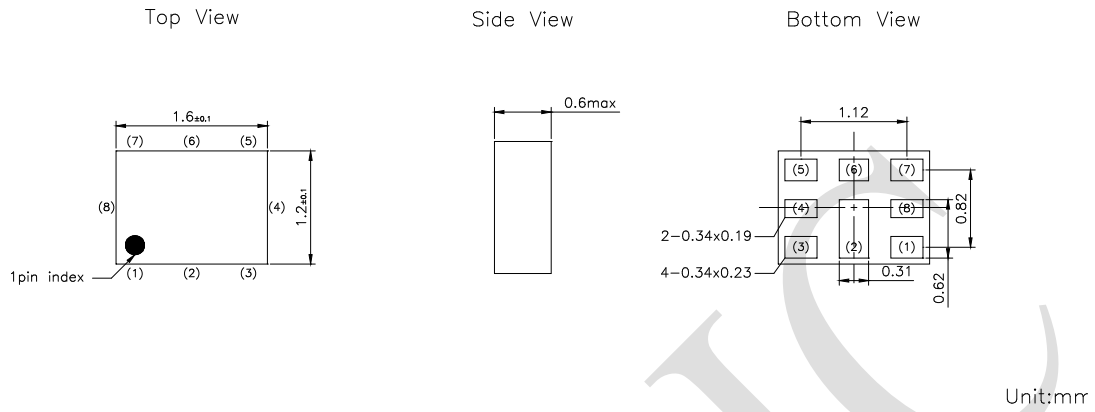

Pin Configuration

- 1 : Rx
- 3 : Tx
- 6 : Ant
- Other : GND

Land Pattern

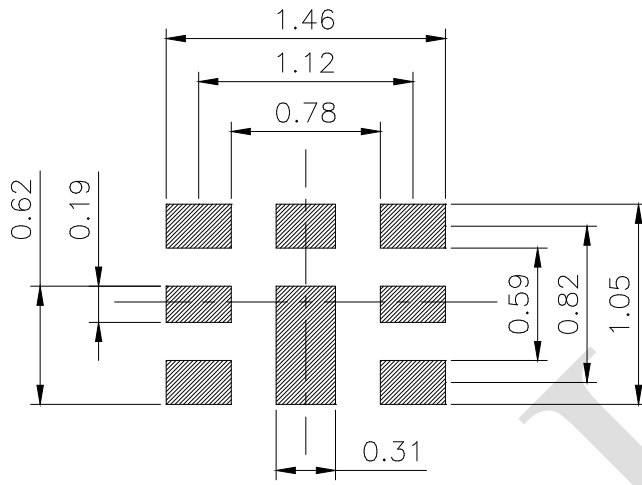

Unit:mm

## Application Circuit

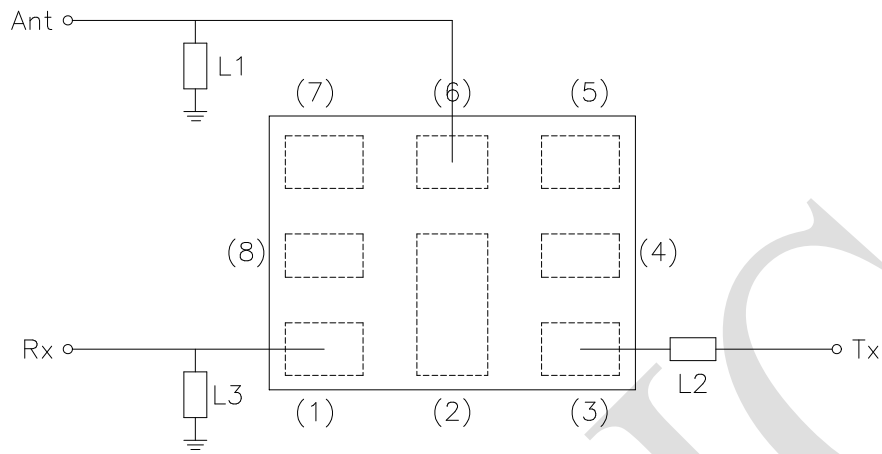

Port	Terminating Z	Matching Component
Ant	50 $\Omega$	L1 : 4.3nH (Ideal inductor)
Tx	50 $\Omega$	L2 : 3.6nH (Ideal inductor)
Rx	50 $\Omega$	L3 : 6.8nH (Ideal inductor)

For ESD protection, external shunt inductor at all ports is recommended.



Electrical Characteristics

Band2 Duplexer

Tx to Ant

Ant to Rx

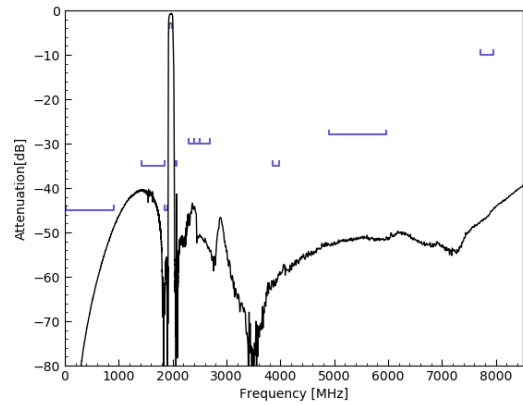
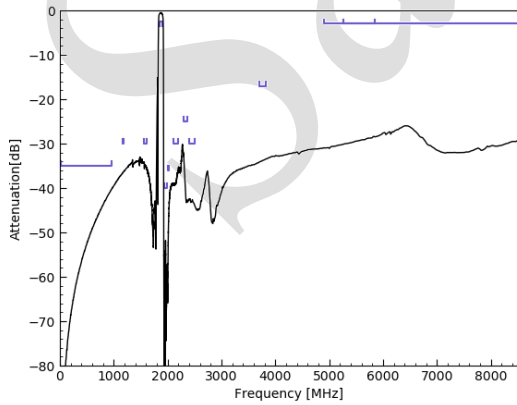
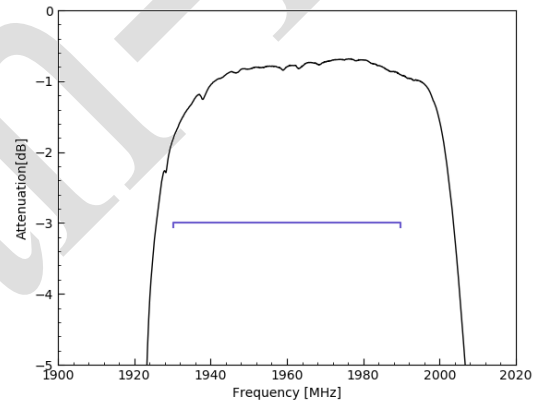
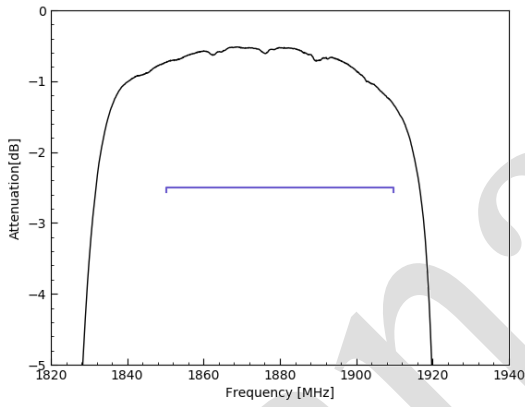
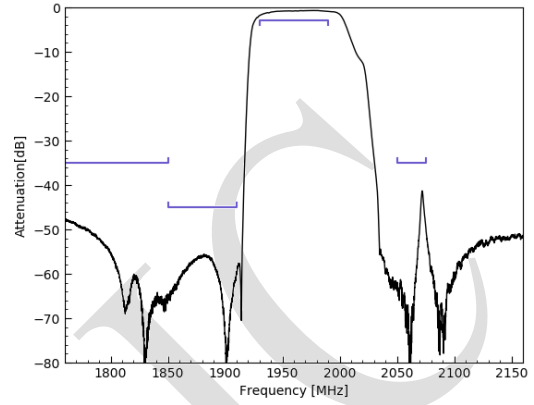
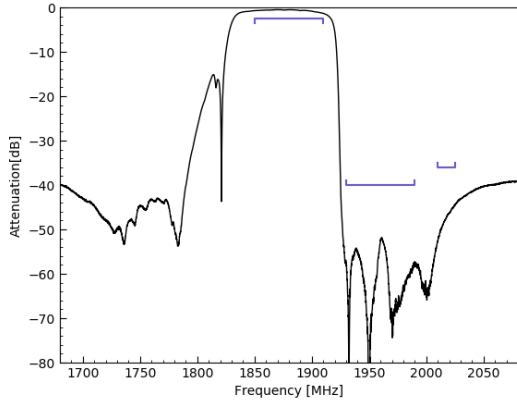

Electrical Characteristics

Band2 Duplexer

Tx to Rx

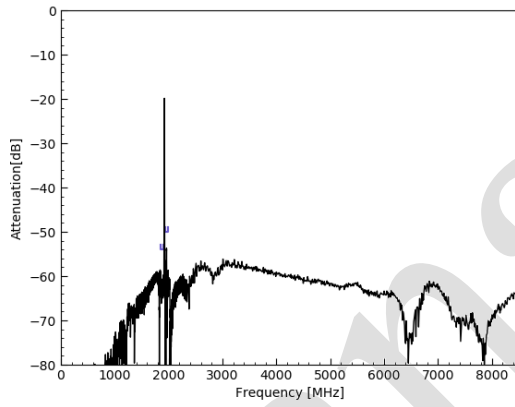
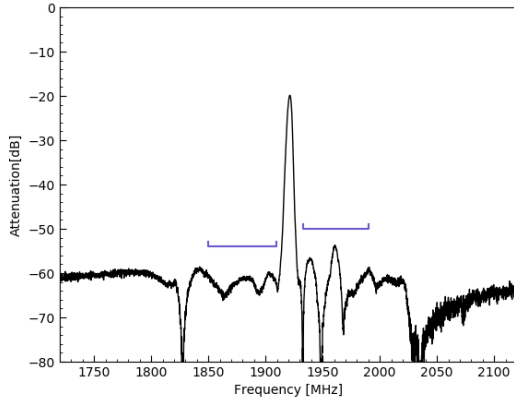

Electrical Characteristics

Band2 Duplexer

Ant Impedance (Tx band)

Ant Impedance (Rx band)

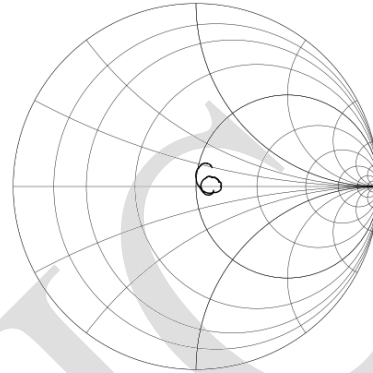
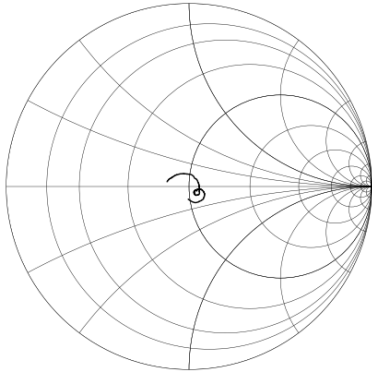

Tx Impedance

Rx Impedance

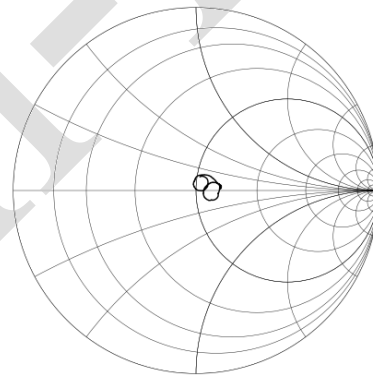
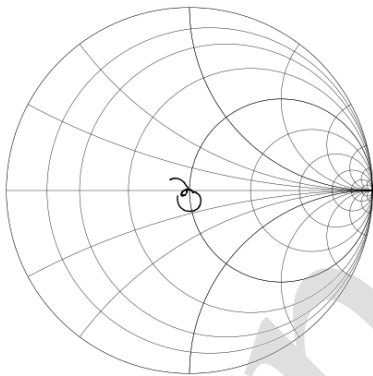

## Marking Information

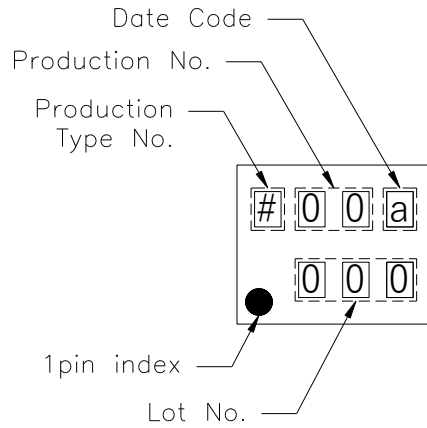

Production type No. (S: Sample, P: Production)

Product No. : 3G

Lot No. (Indicated by 0 ~ 9 or A to Z and a to z, except I, O, i, o and l)

Product date code :

Year	Jan	Feb	Mar	Apr	May	Jun	Jul	Aug	Sep	Oct	Nov	Dec
2023	n	p	q	r	s	t	u	v	w	x	y	z
2024	A	B	C	D	E	F	G	H	J	K	L	M
2025	N	P	Q	R	S	T	U	V	W	X	Y	Z
2026	a	b	c	d	e	f	g	h	j	k	l	m

### Tape Information

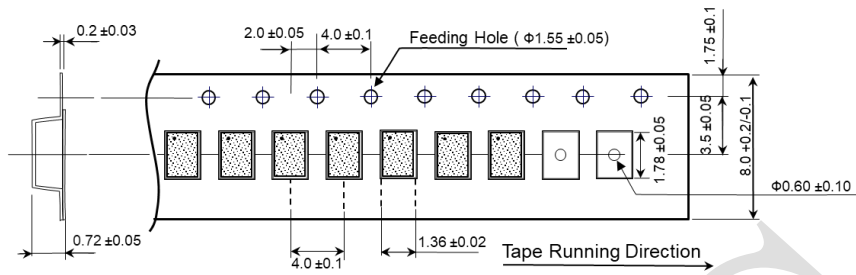

UNIT: mm

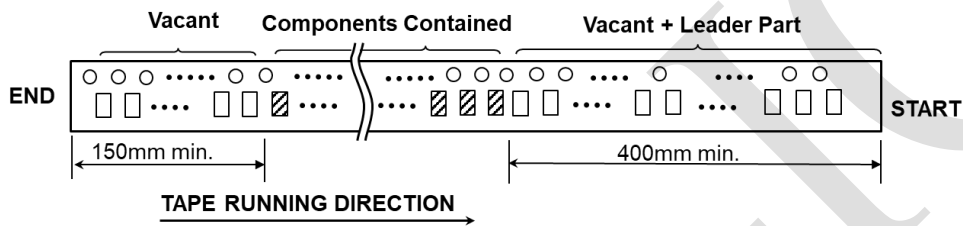

Reel Information

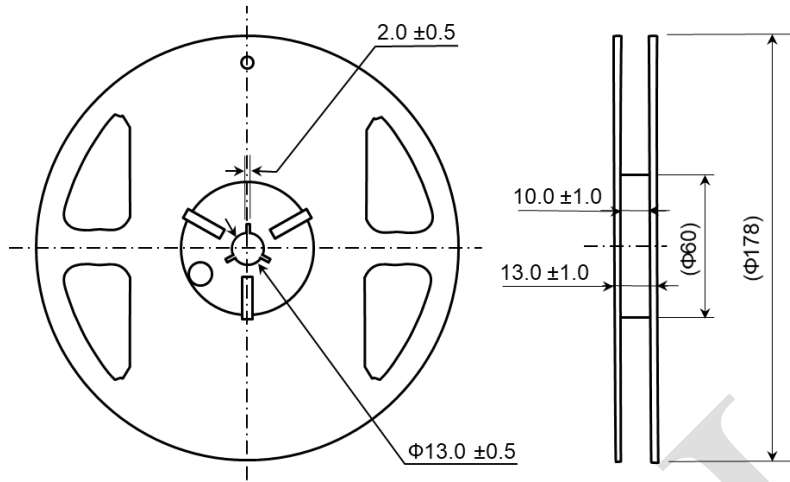

$\Phi 178$  Reel Dimension

UNIT: mm

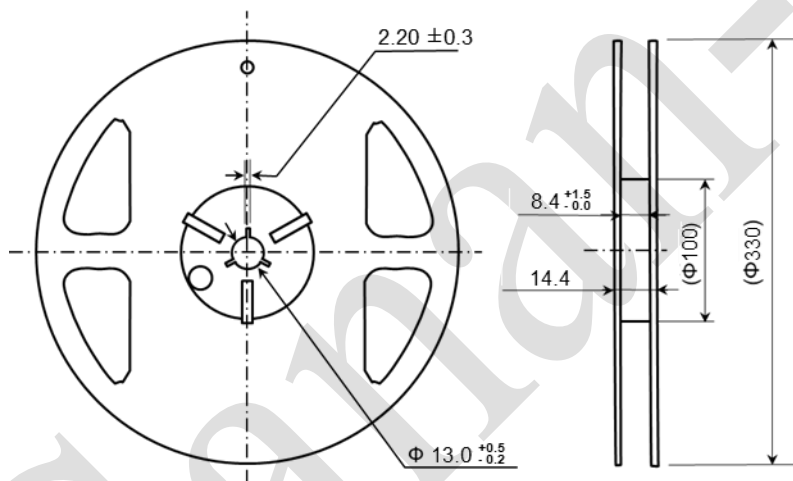

$\Phi 330$  Reel Dimension

UNIT: mm

**Ordering Code**

Part Number	Description
RBD1960G3G-SA	Bulk (few pieces)
RBD1960G3G-MB	Tape & Reel 3,000 pcs/reel
RBD1960G3G-MC	Tape & Reel 10,000 pcs/reel
RBD1960G3G-SZ	EVB

Sanan-IC

### Revision History

Revision	Date	Description
1.0	May. 9, 2023	● Initial release

Sanan-IC



## Important Notice

The information contained herein is as of the date of issue. The products or all information contained herein is subject to change without notice. Quanzhou Sanan Integrated Circuit Co., Ltd. and subsidiaries (hereinafter referred to as "Sanan") assumes no responsibility for errors or omissions in the information contained herein. Customers should verify the latest relevant information before ordering for Sanan products.

All of the contents may be used only for informational purposes by the customer. The information contained herein or any use of such information or Sanan products does not grant, either expressed or implied, to any party the intellectual property rights, patent rights, licenses and related rights. Sanan assume no responsibility for any damages and defects from the use of the information contained herein. Customers should verify Sanan products in actual condition and operating environment before using.

Sanan products are intended for use in mobile phone, PC, AV equipment, OA equipment, home electric appliances, office equipment, or other general electronic equipment. Sanan products are not warranted or authorized for use as critical components in aircraft, power plant, medical, life-saving, life-sustaining and other high reliability applications which can cause severe damages or personal injury or death.

The scope of the warranty of Sanan products is limited to products alone and Sanan does not assume any responsibility for any damages induced by the failure of the products without the express written agreement of Sanan.

Not to be used, duplicated, reproduced, modified, republished and revealed in whole or in part to others without the express written permission of Sanan.