

DATA SHEET

RC02/12/22/32

1%

**Precision chip resistors
sizes 1206, 0805, 0603 and 0402**

Product specification
Supersedes data of 27th March 2001

2002 Apr 09 Rev.9

Precision chip resistors

sizes 1206, 0805, 0603 and 0402

RC02/12/22/32

1%

FEATURES

- Low assembly costs
- High component and equipment reliability
- Excellent performance at high frequency, especially the RC32.
- TC 50 in thick film technology
- Complete precision SMD family.

APPLICATIONS

- All general purpose applications.

DESCRIPTION

The resistors are constructed on a high grade ceramic body (aluminium oxide). Internal metal electrodes are added at each end and connected by a resistive paste which is applied to the top surface of the substrate. The composition of the paste is adjusted to give the approximate resistance required and the value is trimmed to within tolerance, by laser cutting of this resistive layer.

The resistive layer is covered with a protective coat and printed with the resistance value (no printing on RC22H and RC32). Finally, the two external end terminations are added. For ease of soldering the outerlayer of these end terminations is a lead/tin alloy.

QUICK REFERENCE DATA

DESCRIPTION	VALUE					
	RC02H	RC02G	RC12H	RC12G	RC22H	RC32
Size code	1206 (3216)		0805 (2012)		0603 (1608)	0402 (1005)
Resistance range	1 Ω to 10 M Ω	90 Ω to 2.74 M Ω	1 Ω to 10 M Ω	90 Ω to 2.74 M Ω	1 Ω to 10 M Ω	1 Ω to 10 M Ω
Resistance tolerance and E-series	$\pm 1\%$; E24/E96 series					
Temperature coefficient; note 1: 1 $\Omega \leq R \leq 10 \Omega$ 10 $\Omega < R \leq 10 \text{ M}\Omega$	$\leq 250 \pm 250$ $\leq \pm 100$	– $\leq \pm 50$	$\leq 250 \pm 250$ $\leq \pm 100$	– $\leq \pm 50$	$\leq 250 \pm 250$ $\leq \pm 100$	$\leq 250 \pm 250$ $\leq \pm 200$
Maximum dissipation at $T_{\text{amb}} = 70 \text{ }^\circ\text{C}$	0.25 W		0.125 W		0.1 W	0.063 W
Maximum permissible voltage	200 V (DC or RMS)		150 V (DC or RMS)		50 V (DC or RMS)	50 V (DC or RMS)
Climatic category (IEC 60068)	55/155/56					55/125/56
Basic specification	IEC 60115-8					

Note

1. All TC values should be multiplied by $10^{-6}/\text{K}$.

Precision chip resistors

sizes 1206, 0805, 0603 and 0402

RC02/12/22/32

1%

ORDERING INFORMATION

Table 1 Ordering code indicating type and packing

TYPE	ORDERING CODE 2322			
	PAPER TAPE ON REEL			
	5000 units	10000 units	20000 units	50000 units
RC02H	724 6....	724 7....	724 8....	–
RC02G	722 2....	722 3....	–	–
RC12H	734 6....	734 7....	734 8....	–
RC12G	732 6....	732 7....	–	–
RC22H	704 6....	704 7....	704 8....	–
RC32	–	706 7....	–	706 8....
Jumper 0 Ω				
RC02H; note 1	724 92006	724 92007	–	–
RC12H; note 1	734 92006	734 92007	–	–
RC22H; note 2	704 92006	704 92007	–	–

Notes

1. The jumper has a maximum resistance $R_{\max} = 50 \text{ m}\Omega$ and a rated current $I_R = 2 \text{ A}$.
2. The jumper has a maximum resistance $R_{\max} = 50 \text{ m}\Omega$ and a rated current $I_R = 1 \text{ A}$.

Ordering code (12NC)

- The resistors have a 12-digit ordering code starting with 2322.
- The subsequent 4 digits indicate the resistor type and packing; see Table 1.
- The remaining 4 digits indicate the resistance value:
 - The first 3 digits indicate the resistance value.
 - The last digit indicates the resistance decade in accordance with Table 2.

Table 2 Last digit of 12NC

RESISTANCE DECADE	LAST DIGIT
1 to 9.1 Ω	8
10 to 91.0 Ω	9
100 to 910 Ω	1
1 to 9.1 kΩ	2
10 to 91.0 kΩ	3
100 to 910 kΩ	4
1 to 9.1 MΩ	5
10 MΩ	6

ORDERING EXAMPLE

The ordering code of a RC02H resistor, value 4750 Ω, supplied on paper tape of 5000 units per reel is: 2322 724 64752.

Precision chip resistors

sizes 1206, 0805, 0603 and 0402

RC02/12/22/32
1%

FUNCTIONAL DESCRIPTION

Product characterization

Standard values of nominal resistance are taken from the E24/E96 series for resistors with a tolerance of $\pm 1\%$. The values of the E24/96 series are in accordance with "IEC publication 60063".

Limiting values

TYPE	LIMITING VOLTAGE ⁽¹⁾ (V)	LIMITING POWER (W)
RC02	200	0.25
RC12	150	0.125
RC22	50	0.063/0.1
RC32	50	0.063

Note

1. This is the maximum voltage that may be continuously applied to the resistor element, see "IEC publication 60115-8".

DERATING

The power that the resistor can dissipate depends on the operating temperature; see Fig.1.

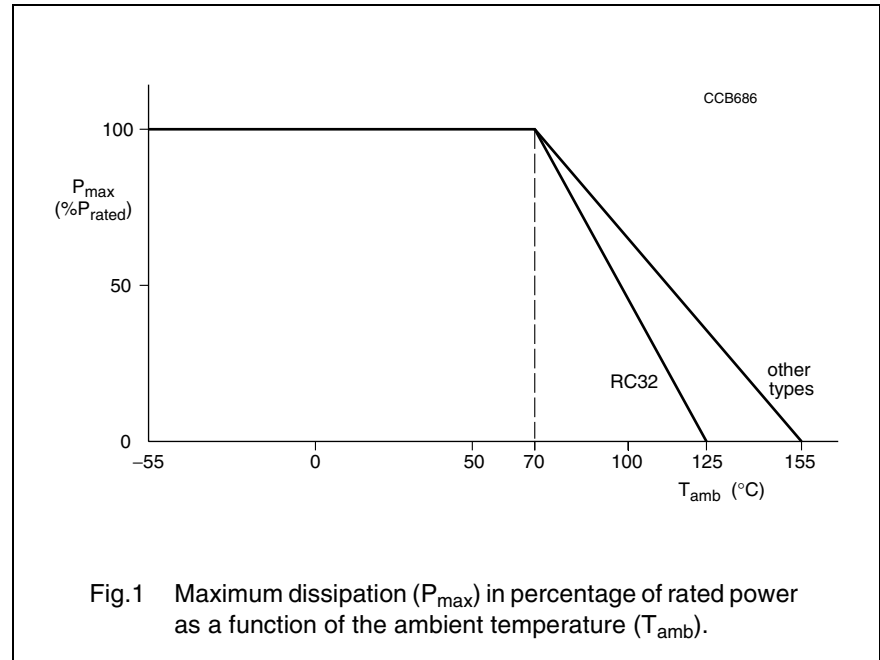
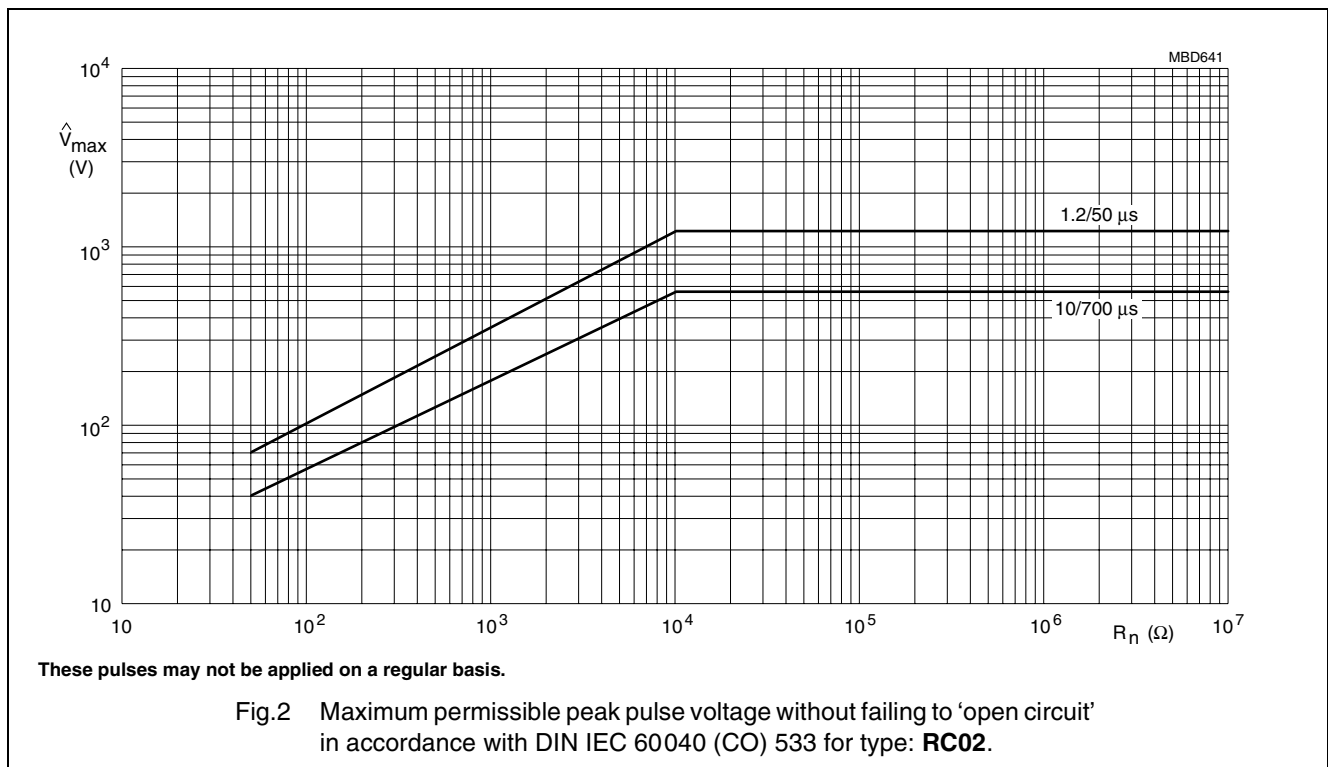

Fig.1 Maximum dissipation (P_{max}) in percentage of rated power as a function of the ambient temperature (T_{amb}).

PULSE LOADING CAPABILITIES



These pulses may not be applied on a regular basis.

Fig.2 Maximum permissible peak pulse voltage without failing to 'open circuit' in accordance with DIN IEC 60040 (CO) 533 for type: **RC02**.

Precision chip resistors
sizes 1206, 0805, 0603 and 0402

RC02/12/22/32
1%

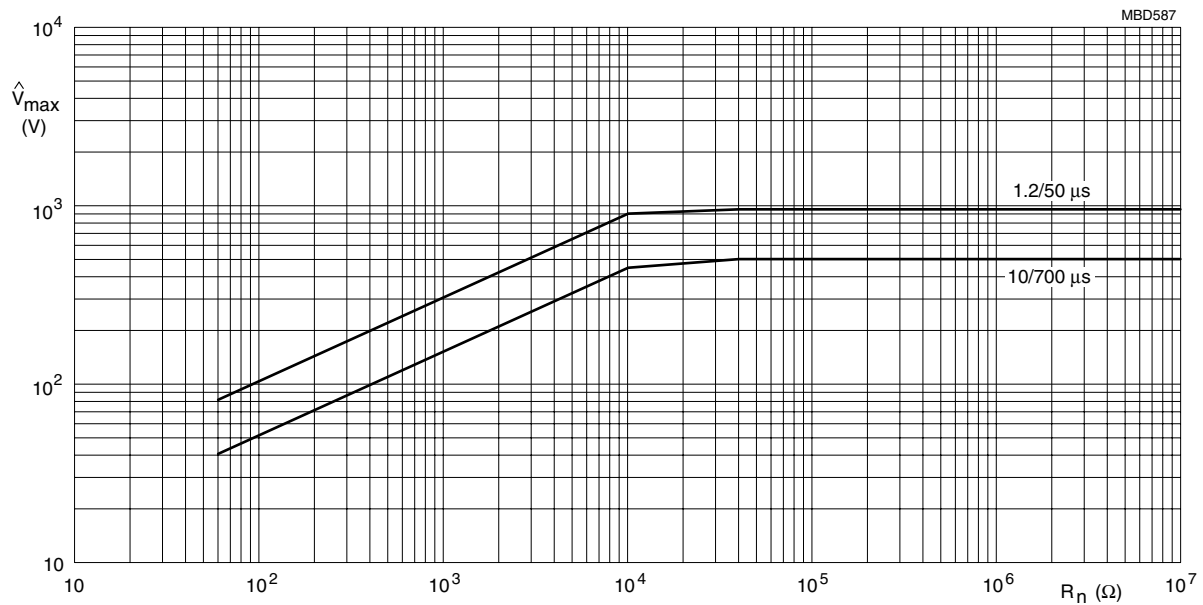

These pulses may not be applied on a regular basis.

Fig.3 Maximum permissible peak pulse voltage without failing to 'open circuit'
in accordance with DIN IEC 60040 (CO) 533 for type: **RC12**.

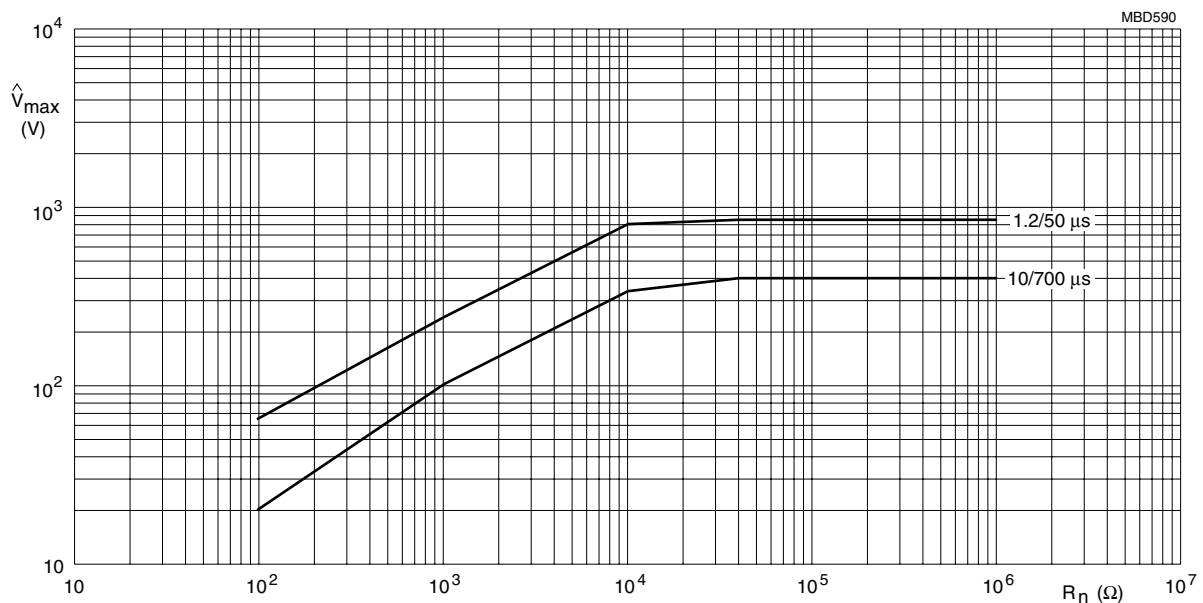

These pulses may not be applied on a regular basis.

Fig.4 Maximum permissible peak pulse voltage without failing to 'open circuit'
in accordance with DIN IEC 60040 (CO) 533 for type: **RC22**.

Precision chip resistors
sizes 1206, 0805, 0603 and 0402

RC02/12/22/32
1%

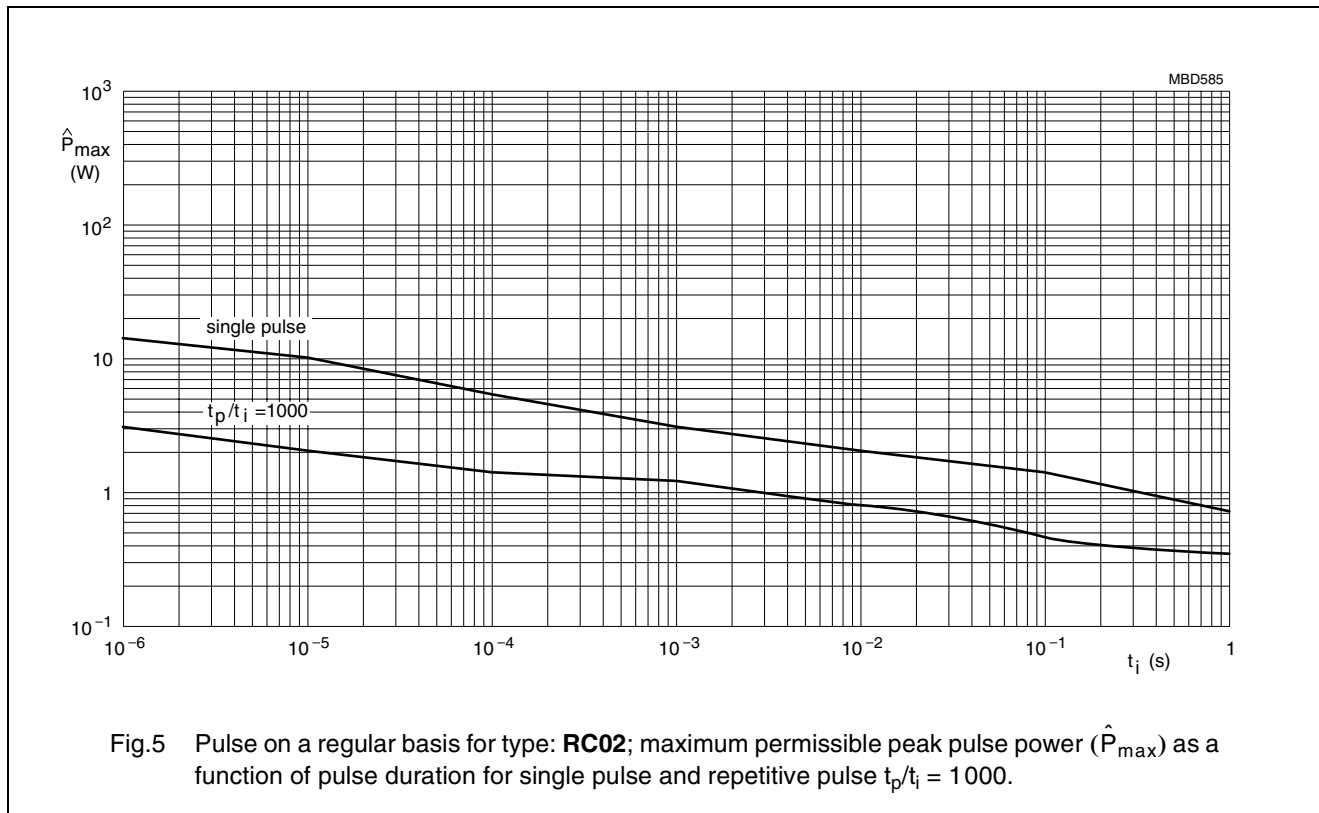

Fig.5 Pulse on a regular basis for type: **RC02**; maximum permissible peak pulse power (\hat{P}_{max}) as a function of pulse duration for single pulse and repetitive pulse $t_p/t_i = 1000$.

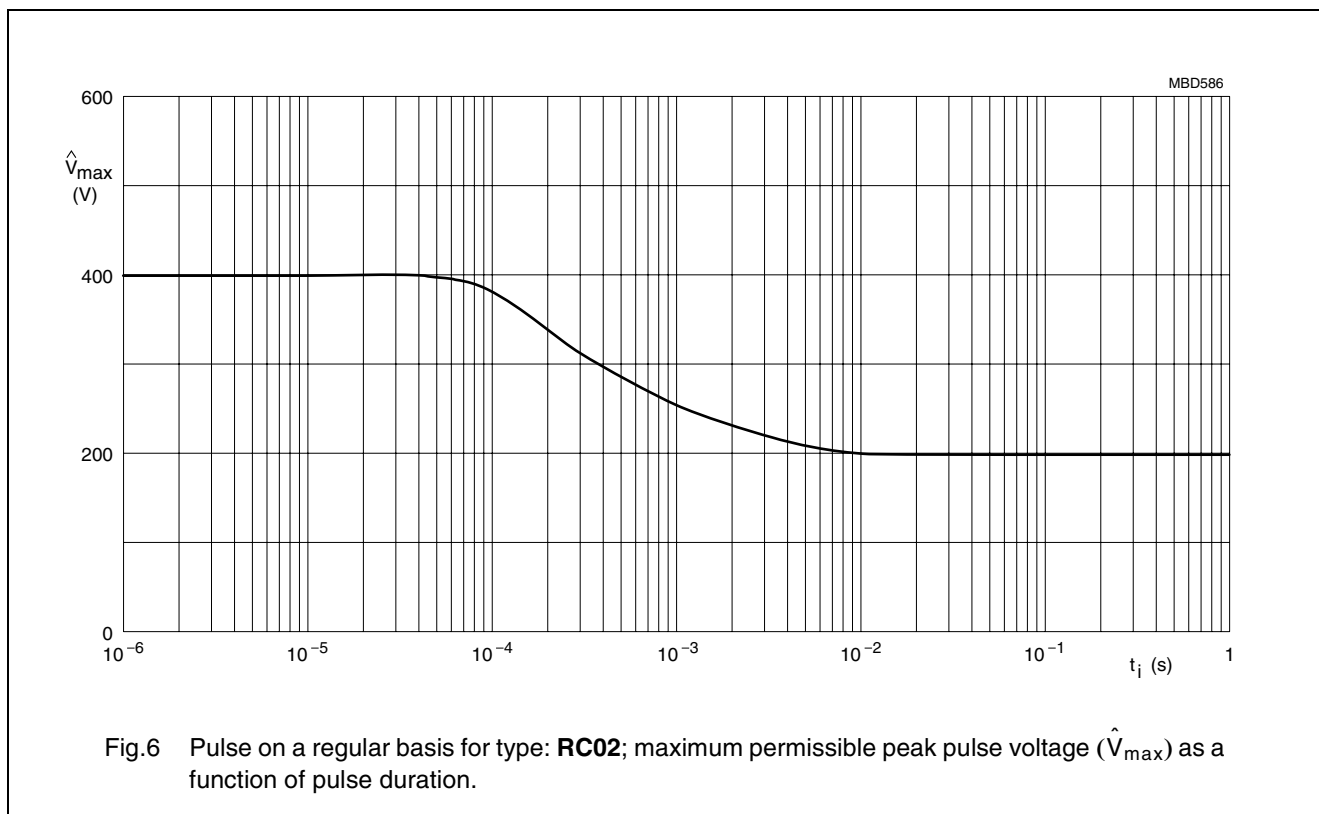
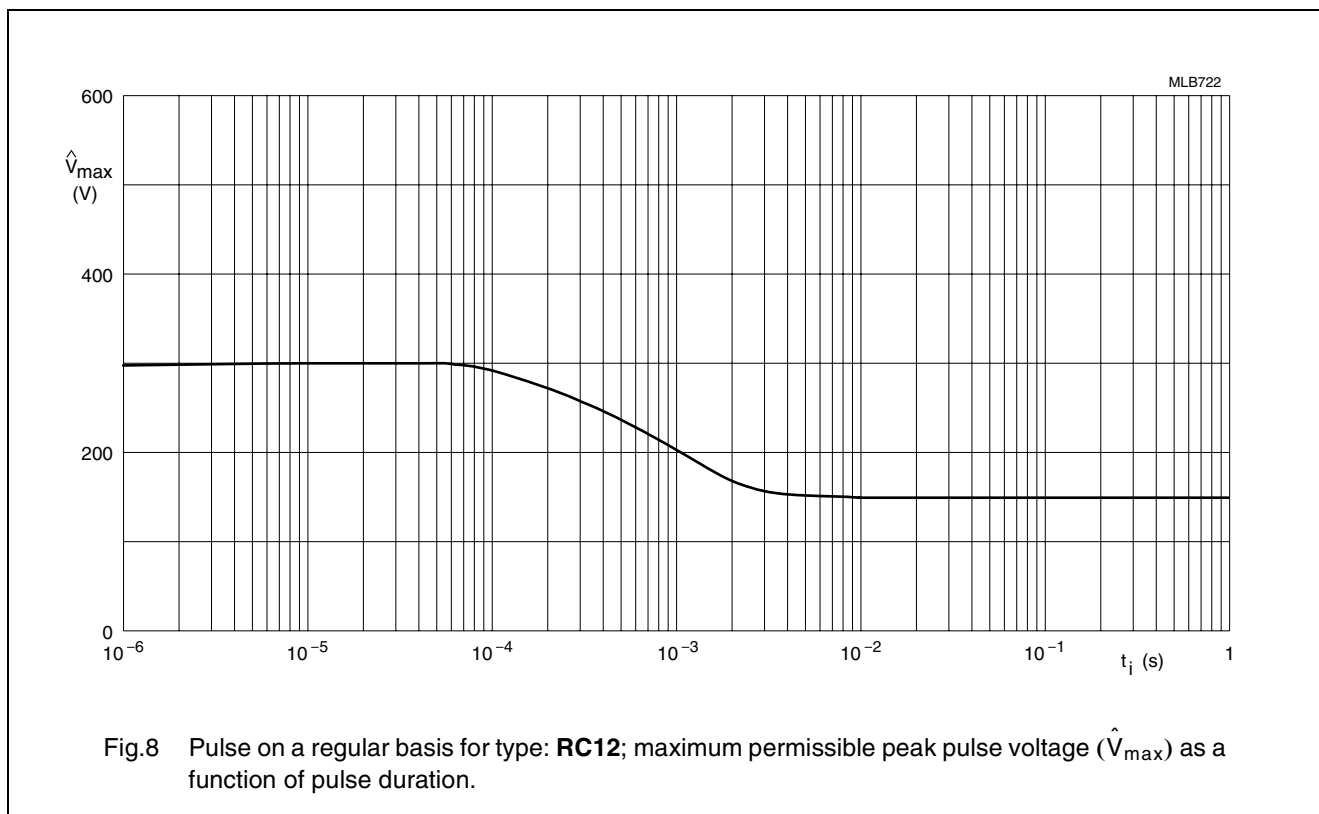
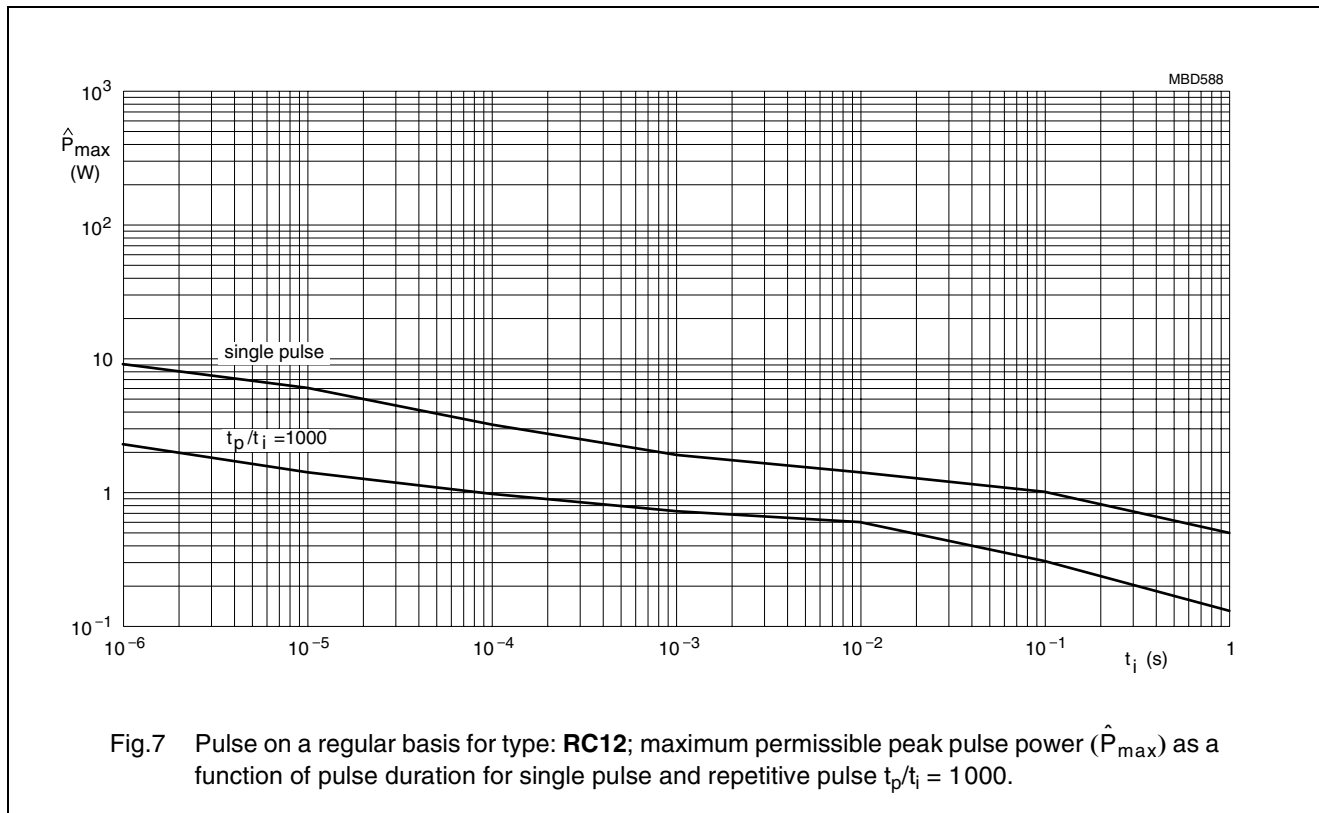

Fig.6 Pulse on a regular basis for type: **RC02**; maximum permissible peak pulse voltage (\hat{V}_{max}) as a function of pulse duration.

Precision chip resistors
sizes 1206, 0805, 0603 and 0402

RC02/12/22/32
1%



Precision chip resistors
 sizes 1206, 0805, 0603 and 0402

RC02/12/22/32
 1%

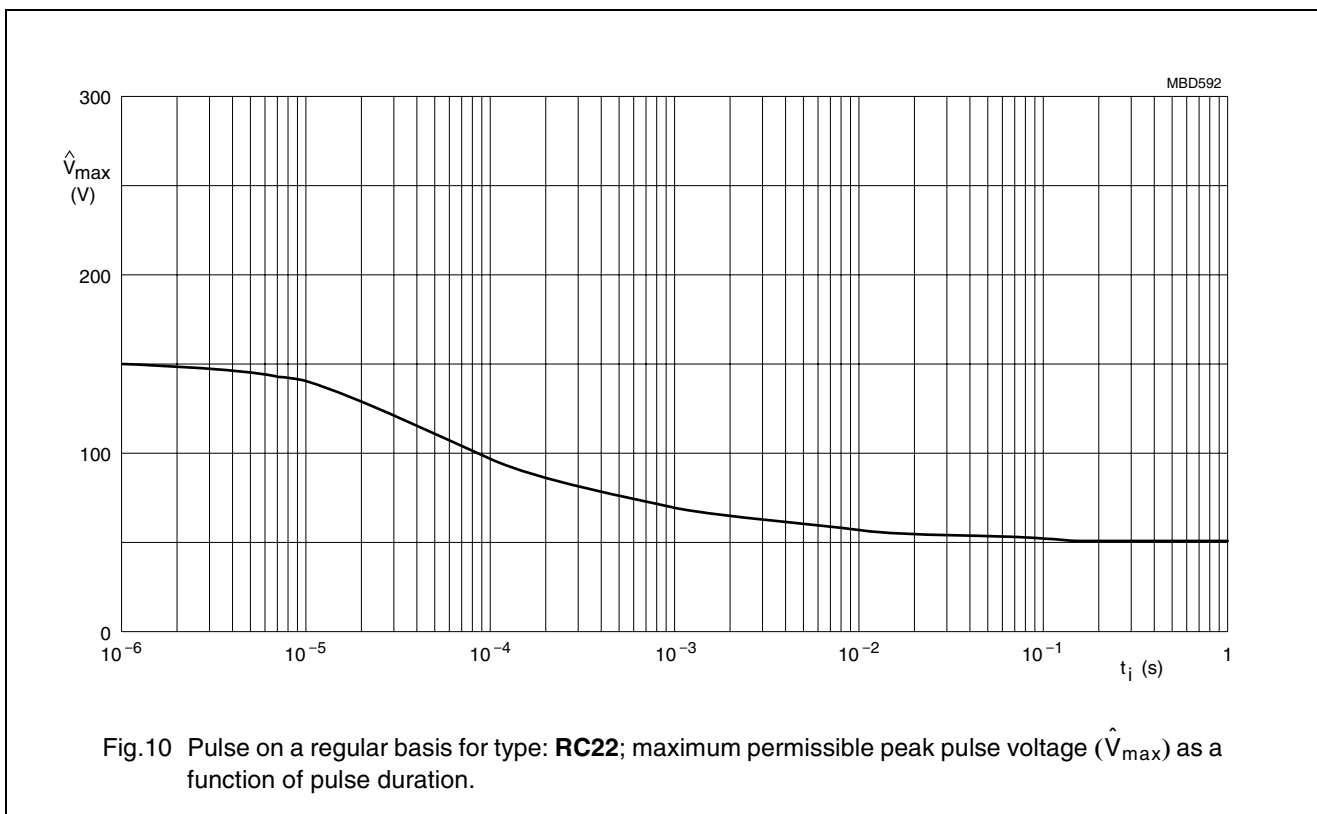
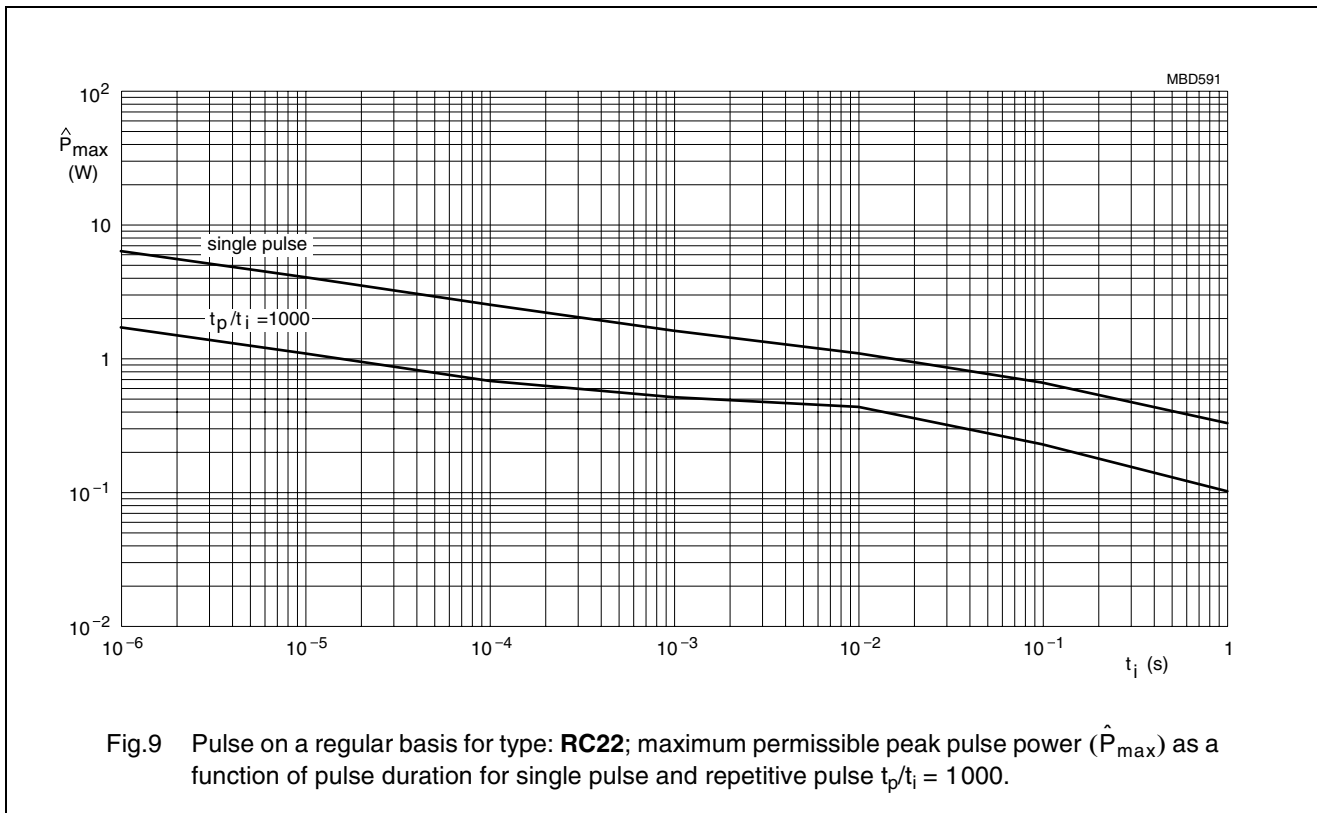

Precision chip resistors
sizes 1206, 0805, 0603 and 0402

RC02/12/22/32
1%

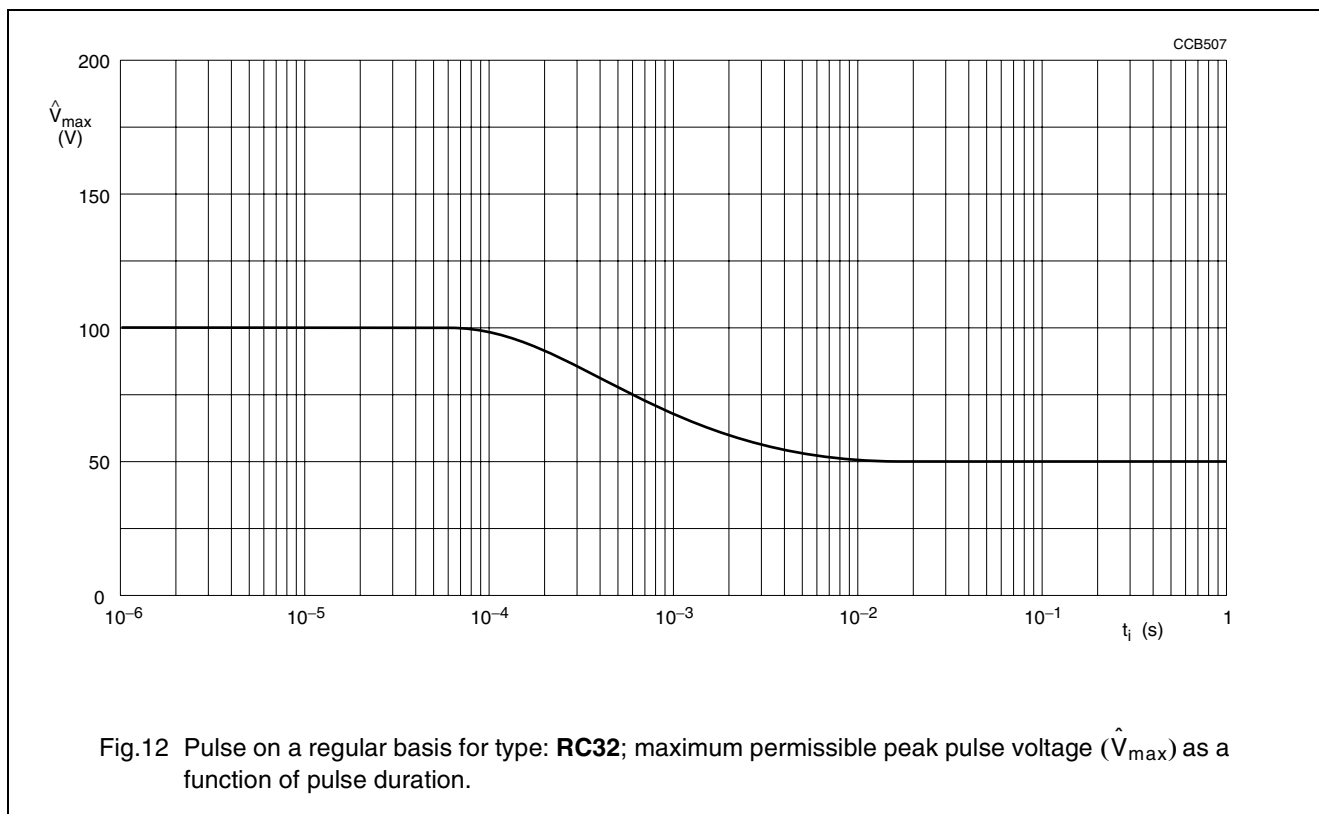
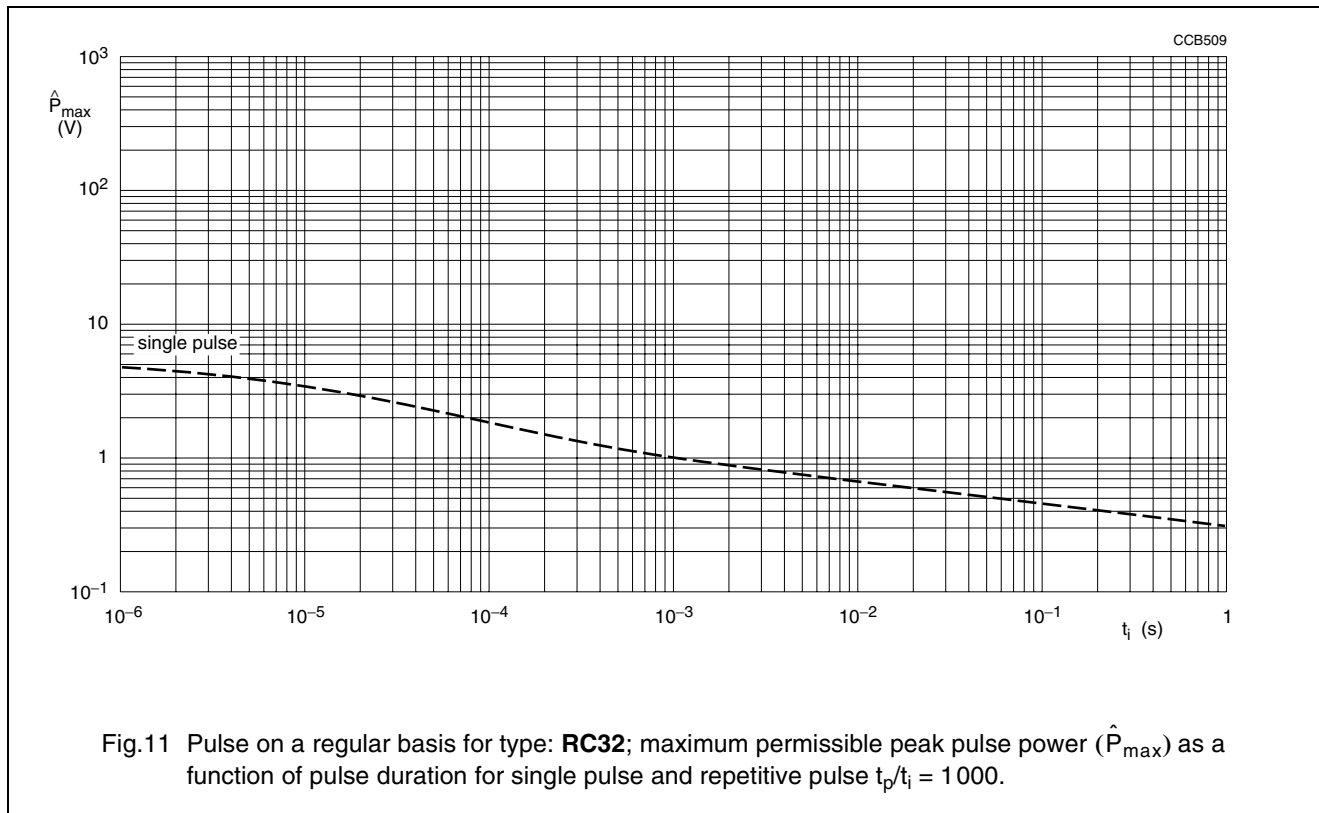

Precision chip resistors

sizes 1206, 0805, 0603 and 0402

RC02/12/22/32

1%

MECHANICAL DATA

Mass per 100 units

TYPE	MASS (g)
RC02	1.0
RC12	0.55
RC22	0.25
RC32	0.058

Marking

All resistors except RC22 and RC32 are marked with a four digit code on the protective coat to designate the nominal resistance value.

4-DIGIT MARKING

For values up to 976Ω the R is used as a decimal point. For values of $1 \text{ k}\Omega$ or greater the first 3 digits apply to the resistance value and the fourth indicates the number of zeros to follow.

Example

MARKING	RESISTANCE
220R	220Ω
4021	$4.02 \text{ k}\Omega$
1503	$150 \text{ k}\Omega$

PACKAGE MARKING

The packing is marked with the resistance value, tolerance, catalogue number, quantity, production period, batch number and source code.

Outlines

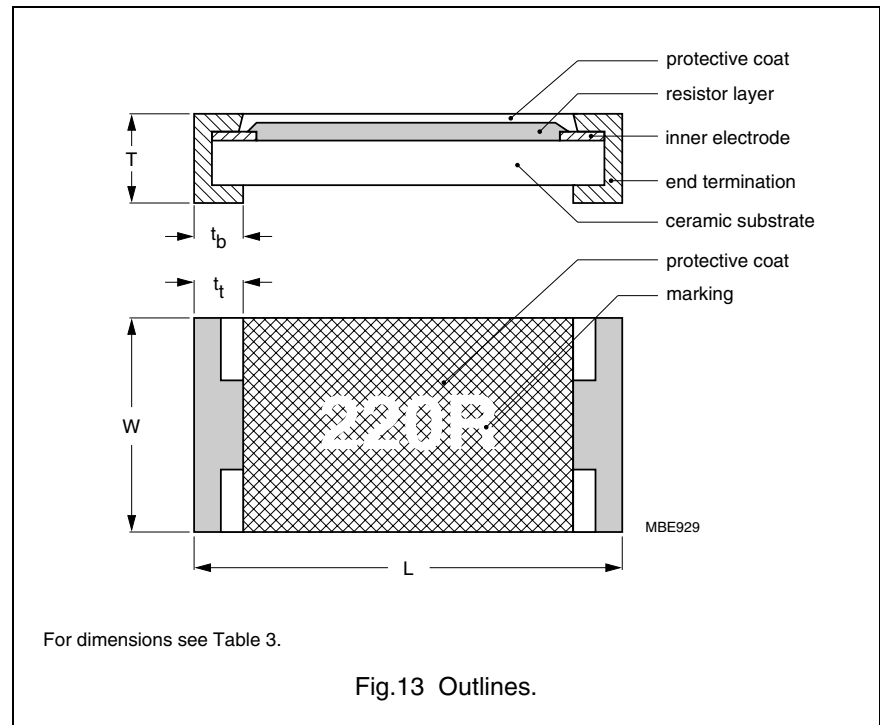

Table 3 Chip resistor types and relevant physical dimensions; see Fig.13

TYPE	L (mm)	W (mm)	T (mm)	t _t (mm)	t _b (mm)
RC02	3.20 +0.10/-0.20	1.60 ±0.15	0.55 ±0.10	0.45 ±0.25	0.50 ±0.25
RC12	2.00 ±0.15	1.25 ±0.15	0.55 ±0.10	0.40 ±0.20	0.40 ±0.20
RC22	1.60 ±0.10	0.80 +0.15/-0.05	0.45 ±0.10	0.30 ±0.20	0.30 ±0.20
RC32	1.00 ±0.05	0.50 ±0.05	0.35 ±0.05	0.20 ±0.10	0.25 ±0.10

Precision chip resistors

sizes 1206, 0805, 0603 and 0402

RC02/12/22/32

1%

TESTS AND REQUIREMENTS

Essentially all tests are carried out in accordance with the schedule of "IEC publication 60115-8", category **LCT/UCT/56** (rated temperature range: Lower Category Temperature, Upper Category Temperature; damp heat, long term, **56** days). The testing also covers the requirements specified by EIA and EIAJ.

The tests are carried out in accordance with IEC publication 60068, "Recommended basic climatic and mechanical robustness testing procedure for electronic components" and under standard atmospheric conditions according to "IEC 60068-1", subclause 5.3.

Unless otherwise specified the following values apply:

Temperature: 15 °C to 35 °C

Relative humidity: 45% to 75%

Air pressure: 86 kPa to 106 kPa (860 mbar to 1060 mbar).

In Table 4 the tests and requirements are listed with reference to the relevant clauses of "IEC publications 60115-8 and 60068"; a short description of the test procedure is also given. In some instances deviations from the IEC recommendations were necessary for our method of specifying.

All soldering tests are performed with mildly activated flux.

Table 4 Test procedures and requirements

IEC 60115-8 CLAUSE	IEC 60068-2 TEST METHOD	TEST	PROCEDURE	REQUIREMENTS				
				RC02H	RC02G	RC12H	RC12G	RC22H
Tests in accordance with the schedule of IEC publication 60115-8								
4.4.1		visual examination		no holes; clean surface; no visible damage				
4.4.2		dimensions (see Fig.13)	gauge (mm)	see Table 3				
4.5		resistance	applied voltage (+0/-10%): R < 10 Ω: 0.1 V 10 Ω ≤ R < 100 Ω: 0.3 V 100 Ω ≤ R < 1 kΩ: 1 V 1 kΩ ≤ R < 10 kΩ: 3 V 10 kΩ ≤ R < 100 kΩ: 10 V 100 kΩ ≤ R < 1 MΩ: 25 V R ≥ 1 MΩ: 50 V	R – R _{nom} : max. ±1%				

Precision chip resistors
sizes 1206, 0805, 0603 and 0402

RC02/12/22/32
1%

IEC 60115-8 CLAUSE	IEC 60068-2 TEST METHOD	TEST	PROCEDURE	REQUIREMENTS					
				RC02H	RC02G	RC12H	RC12G	RC22H	RC32
4.18	20 (Tb)	resistance to soldering heat	unmounted chips; 10 ±1 s; 260 ±5 °C	no visible damage $\Delta R/R$ max.: ±(0.5% +0.05 Ω)					no visible damage $\Delta R/R$ max.: ±(1% +0.05 Ω)
4.29	45 (Xa)	component solvent resistance	isopropyl alcohol or H ₂ O followed by brushing in accordance with "MIL 202 F"	no visible damage					
4.17	20 (Ta)	solderability	unmounted chips completely immersed for 2 ±0.5 s in a solder bath at 235 ±2 °C	good tinning (≥95% covered); no visible damage					
4.7		voltage proof on insulation	maximum voltage (RMS) during 1 minute, metal block method	no breakdown or flashover					
4.13		short time overload	room temperature; $P = 6.25 \times P_n; 5 \text{ s}$ ($V \leq 2 \times V_{max}$)	$\Delta R/R$ max.: ±(1% +0.05 Ω)					$\Delta R/R$ max.: ±(2% +0.1 Ω)
4.33		bending	resistors mounted on a 90 mm glass epoxy resin PCB (FR4), bending: 3 mm for RC02H and RC02G ; 5 mm for RC12H , RC12G , RC22H and RC32	no visible damage $\Delta R/R$ max.: ±(0.5% +0.05 Ω)					no visible damage $\Delta R/R$ max.: ±(1% +0.05 Ω)
4.19	14 (Na)	rapid change of temperature	30 minutes at LCT and 30 minutes at UCT; 5 cycles	no visible damage $\Delta R/R$ max.: ±(0.5% +0.05 Ω)					no visible damage $\Delta R/R$ max.: ±(2% +0.1 Ω)

Precision chip resistors
sizes 1206, 0805, 0603 and 0402

RC02/12/22/32

1%

IEC 60115-8 CLAUSE	IEC 60068-2 TEST METHOD	TEST	PROCEDURE	REQUIREMENTS						
				RC02H	RC02G	RC12H	RC12G	RC22H	RC32	
4.24.2	3 (Ca)	damp heat (steady state)	56 days; 40 ±2 °C; 93 +2/-3% RH; loaded with 0.01 P _n ; R ≤ 1 MΩ R > 1 MΩ	ΔR/R max.: ±(1.0% +0.05 Ω) ΔR/R max.: ±(1.5% +0.05 Ω)						
4.25.1		endurance	1000 +48/-0 hours; 70 ±2 °C; loaded with P _n or V _{max} ; 1.5 hours on and 0.5 hours off: R ≤ 1 MΩ R > 1 MΩ	ΔR/R max.: ±(1.0% +0.05 Ω) ΔR/R max.: ±(1.5% +0.05 Ω)						
4.23.2	27 (Ba)	endurance at upper category temperature	1000 +48/-0 hours; no load: R ≤ 1 MΩ R > 1 MΩ	ΔR/R max.: ±(1.0% +0.05 Ω) ΔR/R max.: ±(1.5% +0.05 Ω)						
4.8.4.2		temperature coefficient	at 20/LCT/20 °C and 20/UCT/20 °C: 1 Ω ≤ R ≤ 10 Ω 10 Ω < R ≤ 10 MΩ	≤250 ±250 ≤±100	-	≤250 ±250 ≤±100	-	≤250 ±250 ≤±100	≤250 ±250 ≤±200	
Other tests in accordance with IEC 60115 clauses and IEC 60068 test method										
4.17	20 (Ta)	solderability (after ageing)	8 hours steam or 16 hours 155 °C; unmounted chips completely immersed for 2 ±0.5 s in a solder bath at 235 ±2 °C	good tinning (≥95% covered); no visible damage						
4.6.1.1		insulation resistance	voltage (DC) after 1 minute, metal block method: 100 V for RC02H , RC02G , RC12H and RC12G , 50 V for RC22H and RC32	R _{ins} min.: 10 ³ MΩ						

Precision chip resistors
sizes 1206, 0805, 0603 and 0402

RC02/12/22/32
1%

REVISION HISTORY

Revision	Date	Change Notification	Description
Rev.8	2001 Mar 07	–	- Converted to Phycomp brand - Pulse duration limit for $R \leq 10 \text{ k}\Omega$ removed in Figs.5, 7, 9 and 11
Rev.9	2002 Apr 09	–	- Maximum dissipation for RC22H changed from 0.063 W/0.1 W to 0.1 W