

PROTECTION PRODUCTS - RailClamp[®]

Description

RailClamp[®] TVS diodes are specifically designed to protect sensitive components which are connected to high-speed data and transmission lines from overvoltage caused by ESD (electrostatic discharge), CDE (cable discharge events), and EFT (electrical fast transients).

The RClamp[®]3354S incorporates surge rated, low capacitance steering diodes and a TVS diode in a single package. Each device will protect up to four high-speed lines. The RClamp3354S can withstand a high level of surge current (25A, 8/20 μ s) while maintaining a low loading capacitance of less than 5pF. The high surge capability means it can be used in high threat environments in applications such as Gigabit Ethernet, telecommunication lines, and LVDS interfaces.

The RClamp3354S is constructed using Semtech's proprietary EPD process technology. The EPD process provides low stand-off voltages with significant reductions in leakage current and capacitance over silicon-avalanche diode processes. It features a low operating voltage of 3.3 volts for superior protection.

The RClamp3354S is in a 5-lead SOT-23 package. The leads are finished with lead-free matte tin.

Features

- ◆ Transient protection for high-speed data lines to **IEC 61000-4-2 (ESD) 30kV (air), 30kV (contact)**
IEC 61000-4-4 (EFT) 40A (5/50ns)
IEC 61000-4-5 (Lightning) 25A (8/20 μ s)
- ◆ Array of surge rated diodes with internal TVS Diode
- ◆ Protects up to four I/O lines
- ◆ Low capacitance (<5pF) for high-speed interfaces
- ◆ Low Dynamic Resistance: 0.25 Ohms
- ◆ Low operating voltage: 3.3V
- ◆ Solid-state silicon-avalanche technology

Mechanical Characteristics

- ◆ JEDEC SOT-23 5L package
- ◆ Pb-Free, Halogen Free, RoHS/WEEE Compliant
- ◆ Molding compound flammability rating: UL 94V-0
- ◆ Marking : Marking code + date code
- ◆ Packaging : Tape and Reel

Applications

- ◆ 10/100/1000 Ethernet
- ◆ Central Office Equipment
- ◆ LVDS Interfaces
- ◆ MagJacks / Integrated Magnetics
- ◆ Notebooks / Desktops / Servers

Circuit Diagram

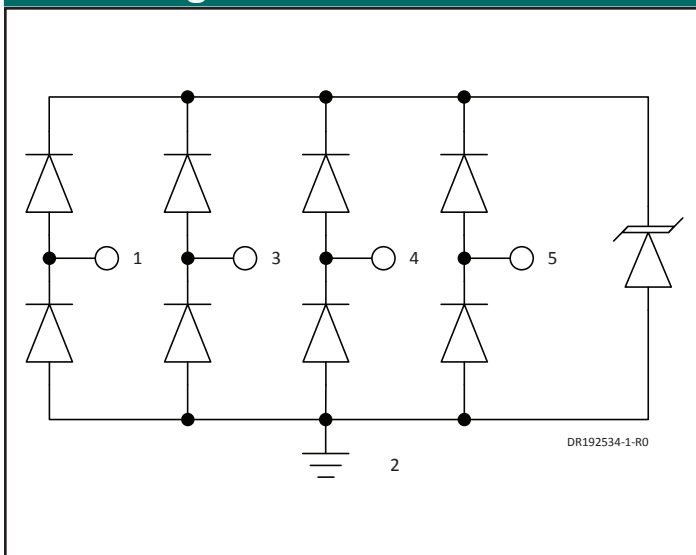

Pin Configuration

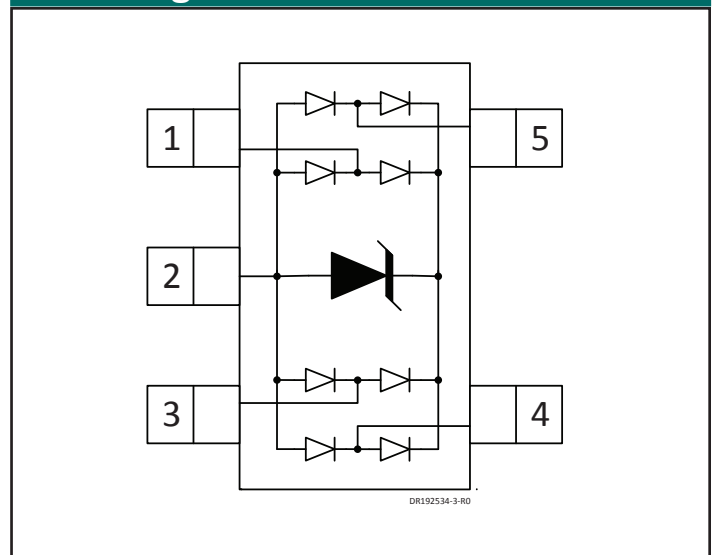

PROTECTION PRODUCTS
Absolute Maximum Ratings

Rating	Symbol	Value	Units
Peak Pulse Power (tp = 8/20μs)	P _{PK}	400	W
Peak Pulse Current (tp = 8/20μs)	I _{PP}	25	A
ESD per IEC 61000-4-2 (Air)	V _{ESD}	30	kV
ESD per IEC 61000-4-2 (Contact)		30	
Operating Temperature	T _J	-55 to +85	°C
Storage Temperature	T _{STG}	-55 to +150	°C

Electrical Characteristics (T=25°C unless otherwise specified)

Parameter	Symbol	Conditions	Min.	Typ.	Max.	Units
Reverse Stand-Off Voltage	V _{RWM}				3.3	V
Punch-Through Voltage	V _{PT}	I _{PT} = 2μA	3.5		5.3	V
Snap-Back Voltage	V _{SB}	I _{SB} = 50mA	2.8			V
Reverse Leakage Current	I _R	V _{RWM} = 3.3V, T=25°C			0.5	μA
Clamping Voltage	V _C	I _{PP} = 1A, tp = 8/20μs Any I/O to Ground			5.5	V
		I _{PP} = 10A, tp = 8/20μs Any I/O to Ground			10	
		I _{PP} = 25A, tp = 8/20μs Any I/O to Ground			16	
Junction Capacitance	C _J	Between I/O pins and Ground V _R = 0V, f = 1MHz		3.8	5	pF
		Between I/O pins V _R = 0V, f = 1MHz		2.0		

PROTECTION PRODUCTS

Typical Characteristics

Non-Repetitive Peak Pulse Power vs. Pulse Time

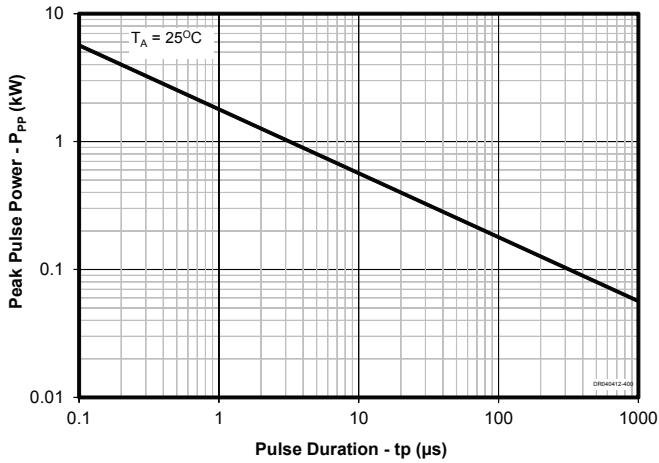

Power Derating Curve

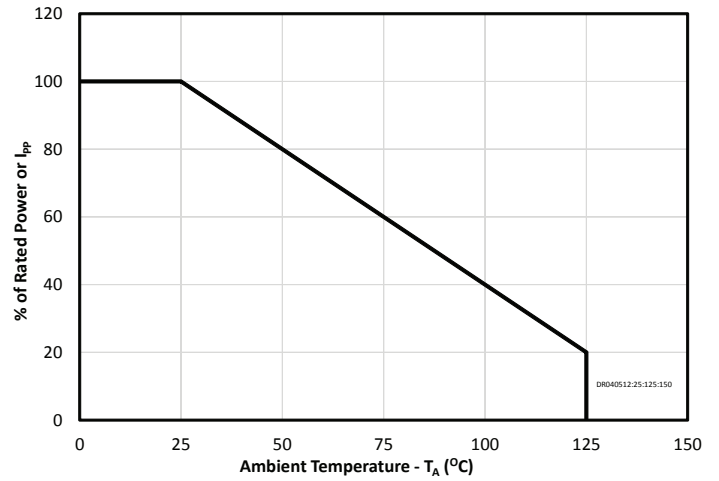

ESD Clamping (+8kV Contact per IEC 61000-4-2)

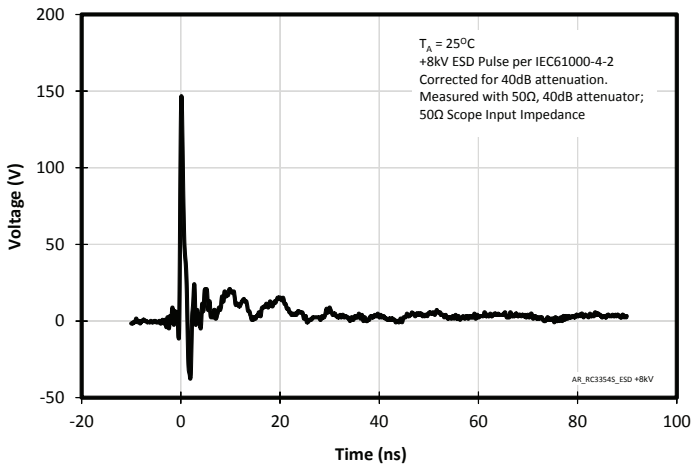

ESD Clamping (-8kV Contact per IEC 61000-4-2)

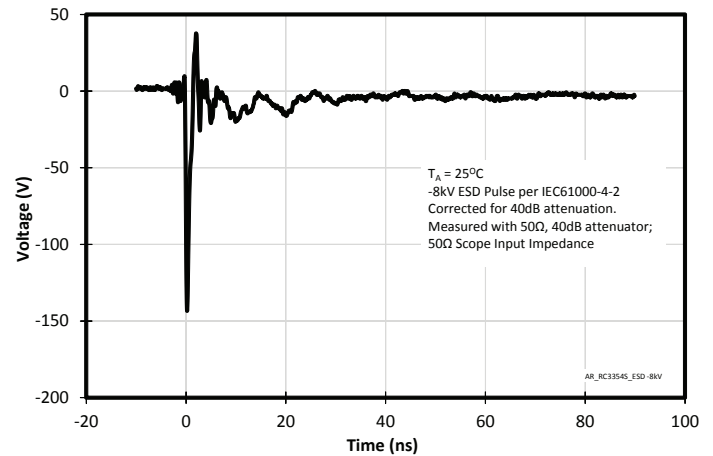

Positive TLP Characteristic

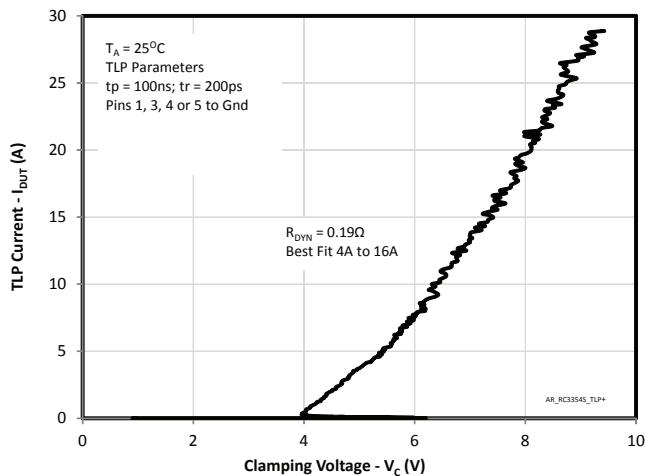

Negative TLP Characteristic

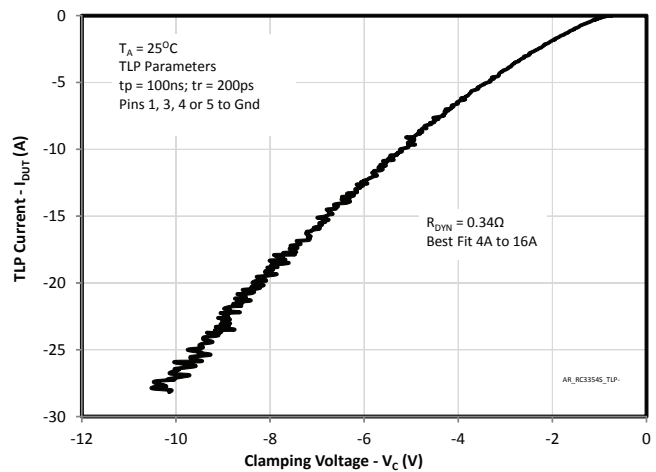

Typical Insertion Loss S21

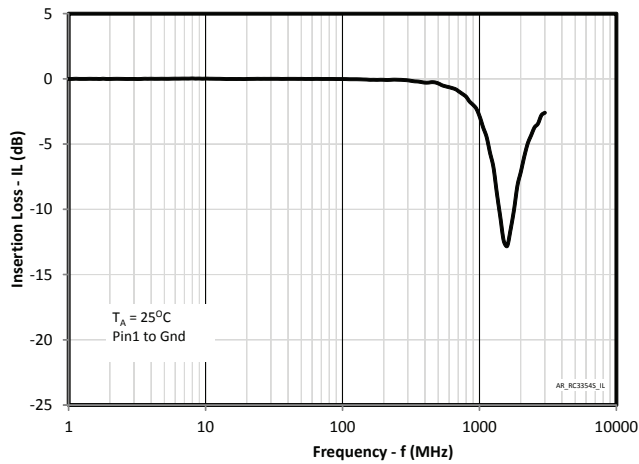

Analog Crosstalk

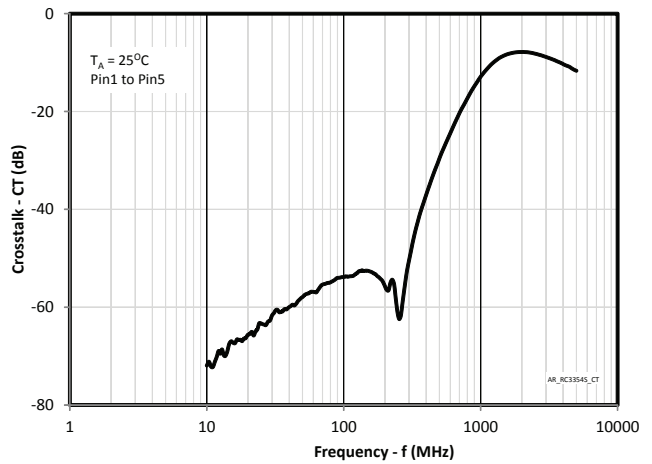

Capacitance v Reverse Voltage (Line to GND)

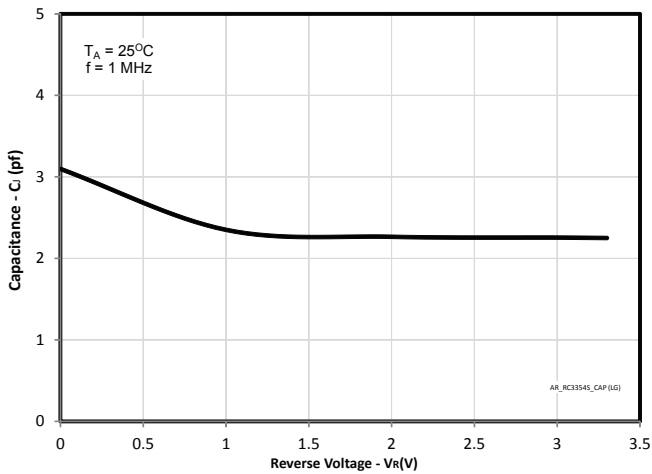

Capacitance v Reverse Voltage (Line to Line)

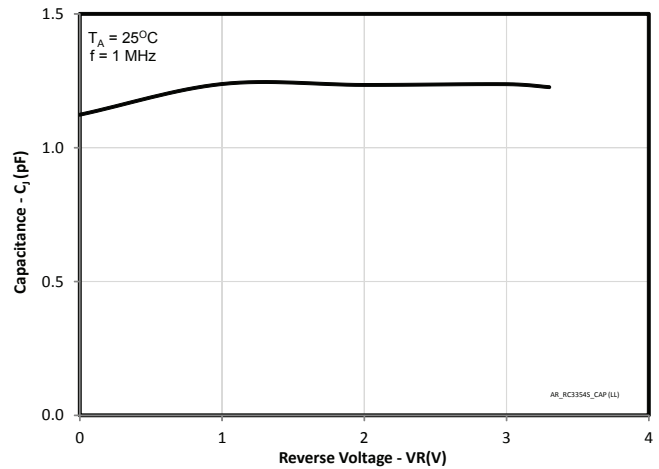

PROTECTION PRODUCTS**Applications Information****Gigabit Ethernet Protection Solutions**

Ethernet systems with connections external to the building are subject to high-level transient threats. This type of equipment may even be required to meet the surge immunity requirements of Telcordia GR-1089. Reliable protection of the Ethernet transceiver requires a device that can absorb the expected transient energy, clamp the incoming surge to a safe level, and yet remain transparent to the system under normal operation. The RClamp3354S has been designed to meet these demanding requirements.

Transient Protection

When designing Ethernet protection, the entire system must be considered. An Ethernet port includes interface magnetics in the form of transformers and common mode chokes. Transformers and chokes can be discrete components, but integrated solutions that include the RJ-45 connector, resistors, capacitors, and protection are also available. In either case, the transformer will provide a high level of common mode isolation to external voltages, but no protection for metallic (line-to-line) surges. During a metallic transient event, current will flow into one line, through the transformer and back to the source. As the current flows, it charges the windings of the transformer on the line side. Once the surge is removed, the windings on the line side will stop charging and will transfer its stored energy to the IC side where the PHY IC is located. The magnitude and duration of the surge is attenuated by the inductance of the magnetics. The amount of attenuation will vary by vendor and configuration of the magnetics. It is this transferred energy that must be clamped by the protection circuitry.

PROTECTION PRODUCTS

Outline Drawing - SOT-23 5L

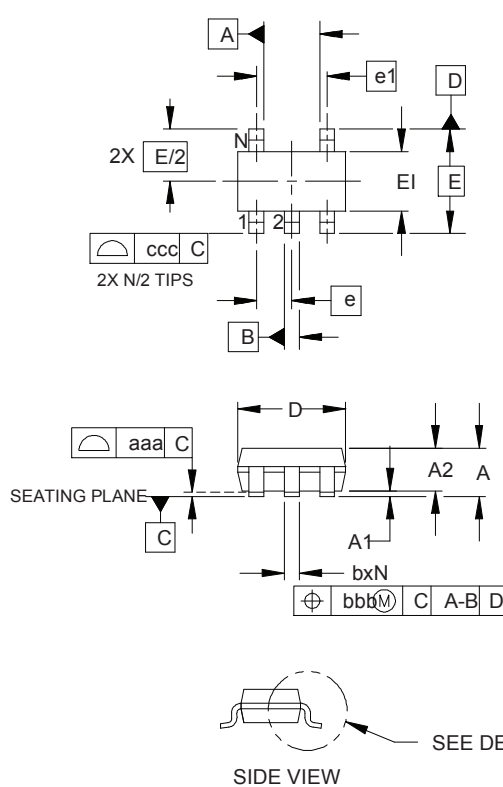

DIM	MILLIMETERS		
	MIN	NOM	MAX
A	0.90	-	1.45
A1	0.00	-	0.15
A2	.90	1.15	1.30
b	0.25	-	0.50
c	0.08	-	0.22
D	2.80	-	3.10
E1	1.50	1.60	1.75
E	2.80 BSC		
e	0.95 BSC		
e1	1.90 BSC		
L	0.30	0.45	0.60
L1	(0.60)		
N	5		
θ1	0°	-	10°
aaa	0.10		
bbb	0.20		
ccc	0.20		

DR192534-10 R0

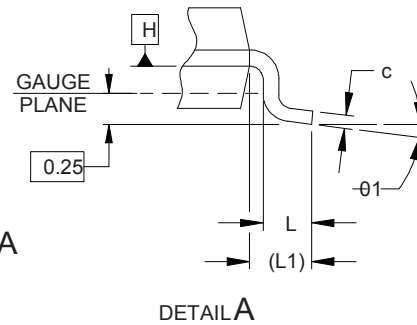

NOTES:

1. CONTROLLING DIMENSIONS ARE IN MILLIMETERS (ANGLES IN DEGREES).
2. DATUMS **A-** AND **B-** TO BE DETERMINED AT DATUM PLANE **H-**
3. DIMENSIONS "E1" AND "D" DO NOT INCLUDE MOLD FLASH, PROTRUSIONS OR GATE BURRS.

Land Pattern - SOT-23 5L

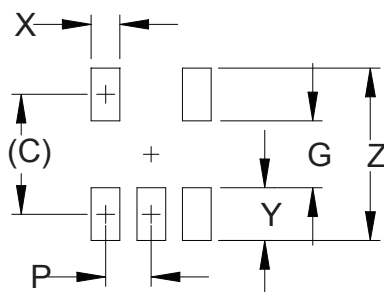

DIMENSIONS	
DIM	MILLIMETERS
C	(2.50)
G	1.40
P	0.95
X	0.60
Y	1.10
Z	3.60

DR192534-11-R0

NOTES:

- 1.
2. THIS LAND PATTERN IS FOR REFERENCE PURPOSES ONLY. CONSULT YOUR MANUFACTURING GROUP TO ENSURE YOUR COMPANY'S MANUFACTURING GUIDELINES ARE MET.

PROTECTION PRODUCTS

Marking

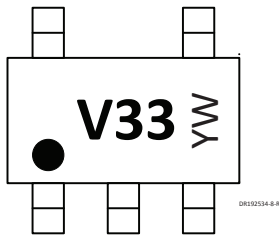

YW = Alphanumeric character Date Code

Ordering Information

Part Number	Lead Finish	Qty per Reel	Reel Size
RClamp3354S.TCT	Matte Tin	3,000	7 inch

RailClamp and RClamp are Trademarks of Semtech Corporation

Tape and Reel Specification

10 Pitches Cumulative Tolerance on Tape $\pm 0.2\text{mm}$ ($\pm 0.008''$)

DR192534-8-R0

DR192533-1-R0

DR192534-9-R0

Pin 1 Location

User Direction of feed

All dimensions in mm

A0	B0	K0	B (Max)	D	D1	E	F	K (Max)	P	P0	P2	T (MAX)	W
3.23 ± 0.05	3.17 ± 0.05	1.37 ± 0.05	4.2	1.5 +0.1 -0.0	1.0 ± 0.05	1.75 ± 0.10	3.5 ± 0.05	2.4	4.0 ± 0.1	4.0 ± 0.1	2.0 ± 0.05	0.4	8.0 +0.3 -0.1

Contact Information

Semtech Corporation
 Protection Products Division
 200 Flynn Rd., Camarillo, CA 93012
 Phone: (805)498-2111 FAX (805)498-3804