

Specification
For
LTCC 3dB Hybrid Coupler

Model Name : RCP200B03

Customer :

Title:

Name :

APPROVED

By Date : _____

Signature : _____

RN2 Technologies co., Ltd.

RN2 Technologies co., Ltd.

284-2, Galgot-ri, Jinwe-myeon,

Pyeongtaek-si, Kyunggi-do, KOREA

Phone : (+82) 31 - 376 - 5400

FAX : (+82) 31 - 376 - 9151

Issued Date : _____

Designed : _____

Approved : _____

1. Description

1-1. Part number: RCP200B03

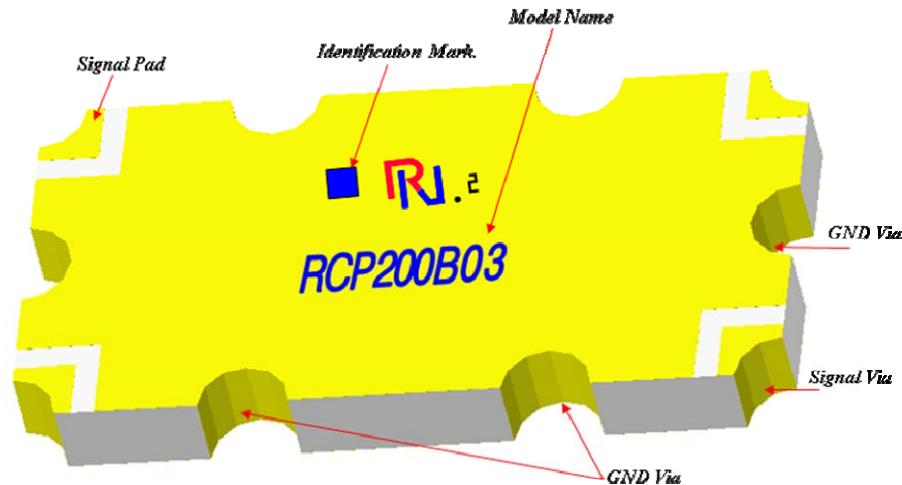

1-2. Features

- Hybrid Coupler 3dB, 90°
- Surface mount type
- Suitable for operation frequency 180~210MHz
- **RoHS** compliance
- High stability in temperature and humidity for LTCC base
- Low loss for Silver(Ag) conductor
- Miniature size and high power capability
- Lead-free alloy solderable
- Thermal expansion corresponding with common substrate

2. Electrical Specification

Freq. (MHz)	Amplitude Balance max (dB)	Isolation min (dB)	Insertion Loss max (dB)
180-210	± 0.30	-20	-0.3
VSWR Max	Phase (degrees)	Power Capacity Avg. (Watt)	Operating Temp. (°C)
1.2	90 ± 3.0	200	-55 to +125

3. Mechanical Specification

3-1. Outline Dimension

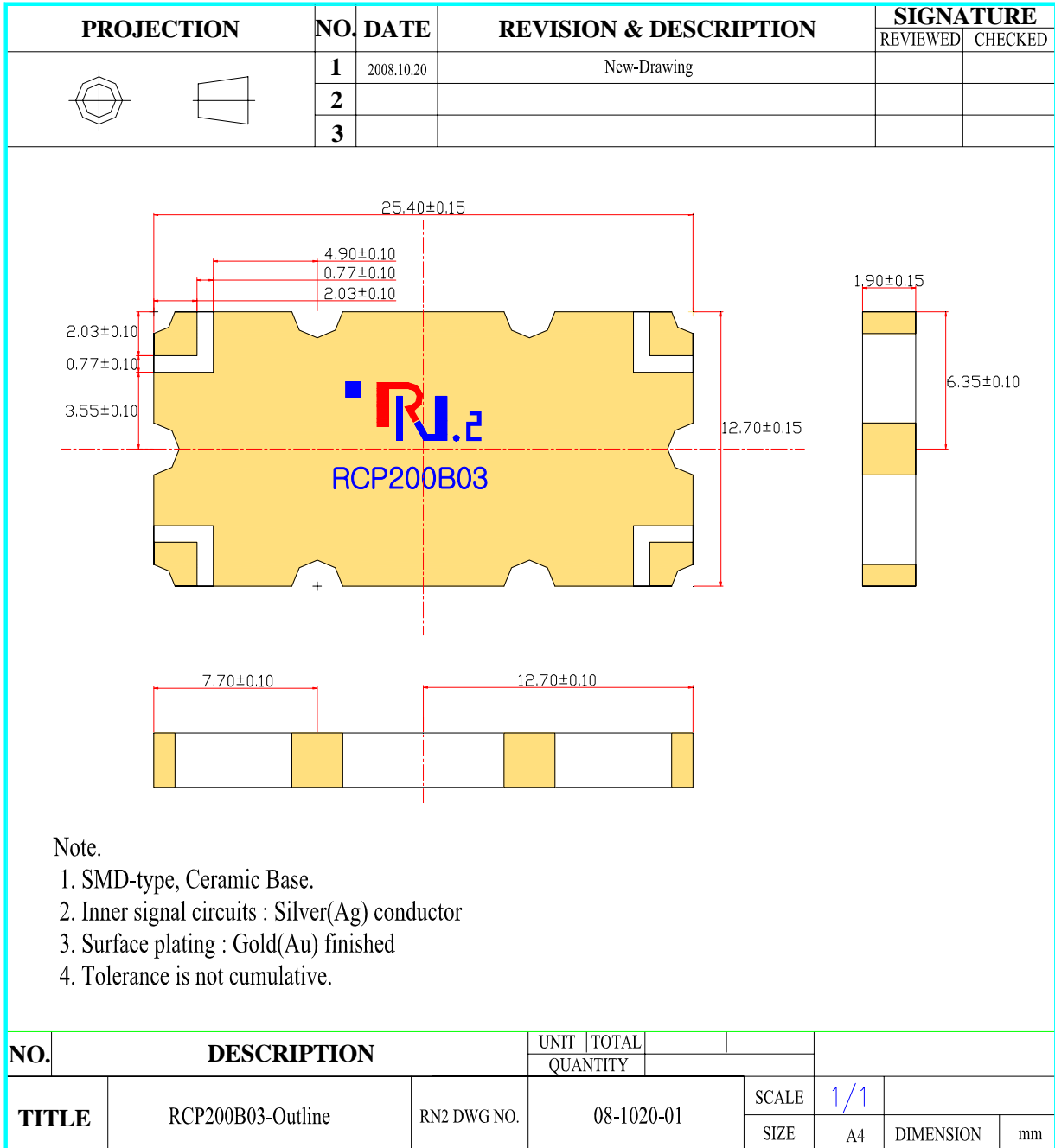

3-2. Weight

- 2.45 Grams typical

4. Port Configuration

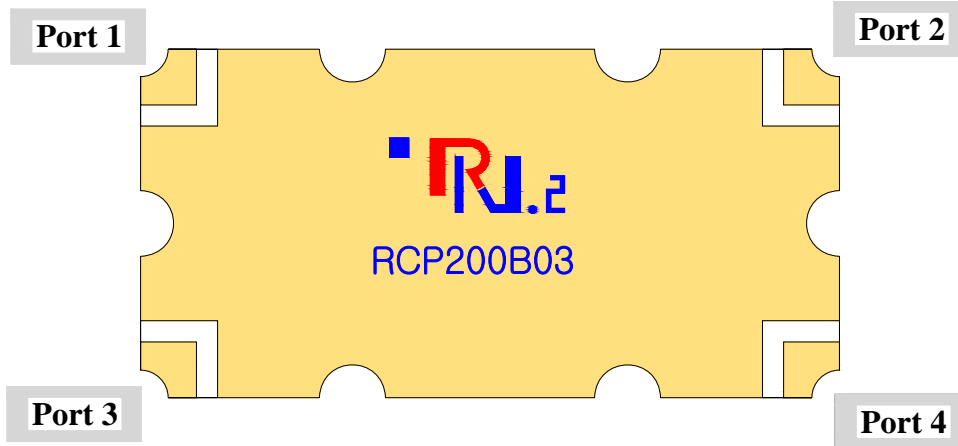

Configuration	Port 1	Port 2	Port 3	Port 4
Case 1.	Input	Isolated	Coupling -3dB, 0°	Output -3dB, -90°
Case 2.	Isolated	Input	Output -3dB, 90°	Coupling -3dB, 0°
Case 3.	Coupling -3dB, 0°	Output -3dB, 90°	Input	Isolated
Case 4.	Output -3dB, 90°	Coupling -3dB, 0°	Isolated	Input

* Once Port 1 is determined, the other three ports are defined automatically.

5. Schematic Drawing



6. Typical Performance Data (25 °C)

Freq. [MHz]	Coupling [dB]	Out [dB]	IL [dB]	Amp.Bal. [dB]	Phase [degree]	Return Loss [dB]			
						S11	S22	S33	S44
180	-3.15	-3.26	-0.1944	±0.055	-91.16	-27.11	-26.9	-27.84	-25.36
182	-3.15	-3.27	-0.1993	±0.06	-91.19	-27.43	-27.03	-28.05	-25.51
184	-3.14	-3.27	-0.1942	±0.065	-91.23	-28.07	-27.49	-29.01	-25.65
186	-3.14	-3.28	-0.1991	±0.07	-91.3	-28.03	-27.19	-28.33	-25.77
188	-3.14	-3.28	-0.1991	±0.07	-91.31	-28.29	-27.22	-28.39	-25.86
190	-3.15	-3.29	-0.2091	±0.07	-91.36	-28.52	-27.2	-28.38	-25.93
192	-3.15	-3.29	-0.2091	±0.07	-91.41	-28.71	-27.14	-28.32	-25.98
194	-3.15	-3.29	-0.2091	±0.07	-91.45	-28.84	-27.04	-28.2	-25.99
196	-3.15	-3.29	-0.2091	±0.07	-91.49	-28.91	-26.89	-28.02	-25.97
198	-3.16	-3.29	-0.2142	±0.065	-91.53	-28.92	-26.71	-27.78	-25.93
200	-3.17	-3.29	-0.2193	±0.06	-91.56	-28.87	-26.49	-27.49	-25.85
202	-3.19	-3.28	-0.2245	±0.045	-91.61	-28.75	-26.24	-27.17	-25.74
204	-3.19	-3.28	-0.2245	±0.045	-91.65	-28.54	-25.95	-26.81	-25.59
206	-3.21	-3.27	-0.2296	±0.03	-91.7	-28.29	-25.64	-26.42	-25.41
208	-3.23	-3.26	-0.2347	±0.015	-91.74	-27.97	-25.3	-26	-25.2
210	-3.25	-3.26	-0.2447	±0.005	-91.78	-27.6	-24.95	-25.57	-24.97

7. Operation Temperature Curve (a)

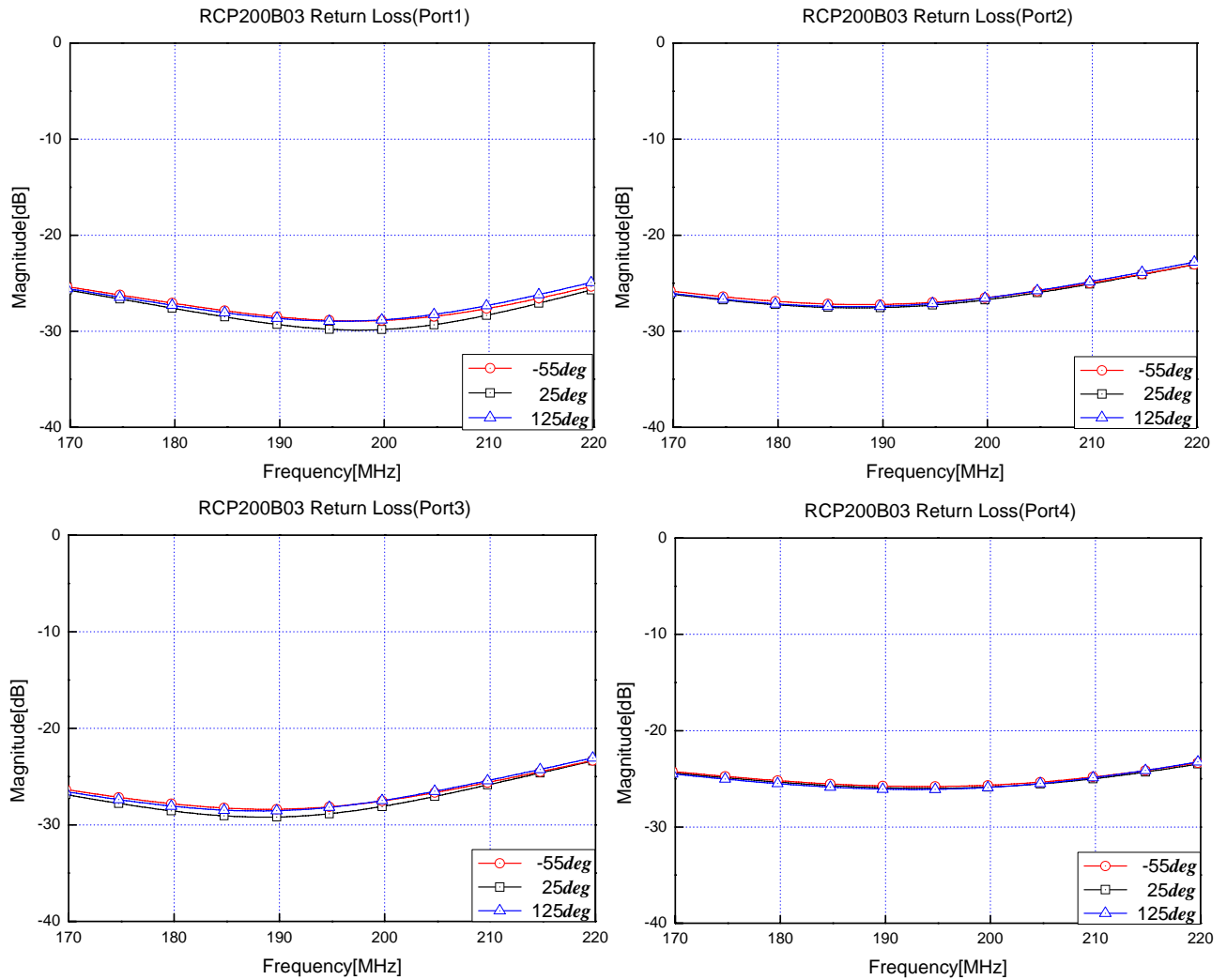

8. Operation Temperature Curve (b)

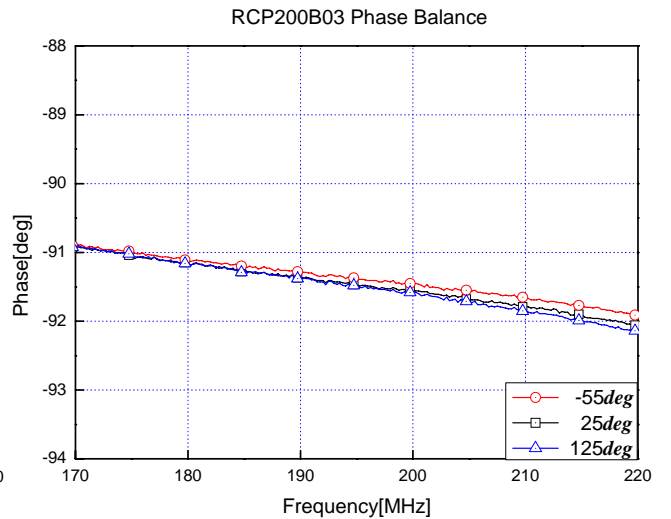
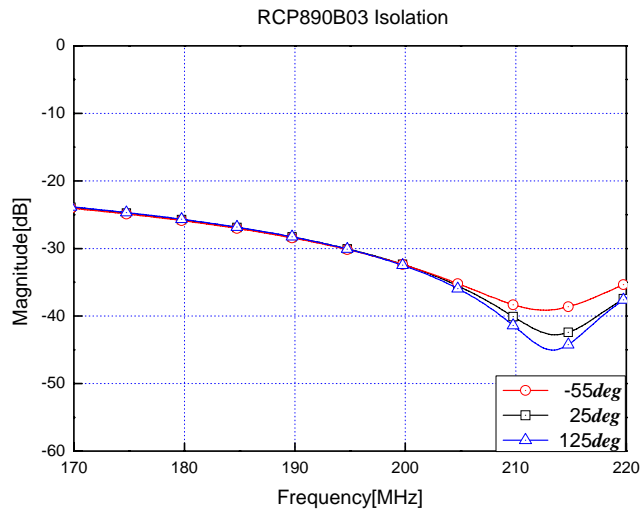
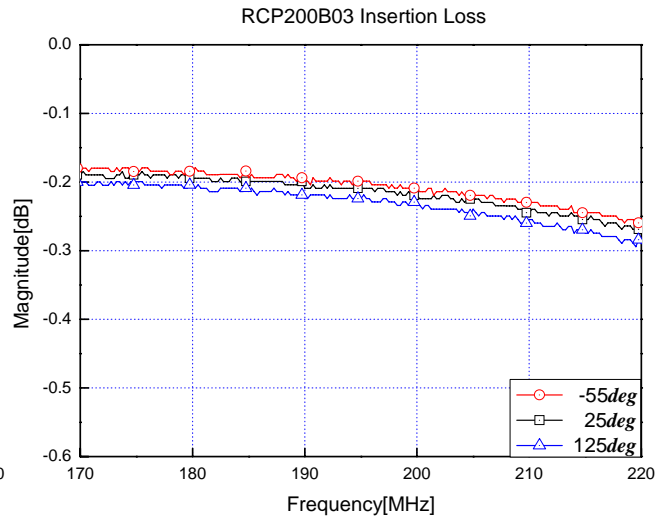

9. Test Method

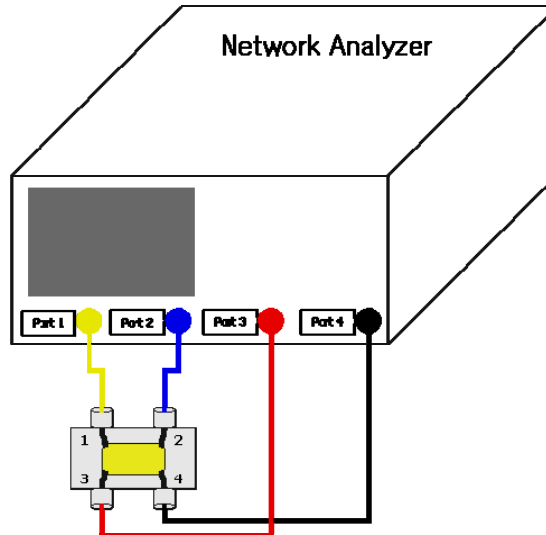

- Refer to 'Case 1' of '4. Port Configuration' on page 4
- Have the network analyzer calibrated properly.
- Measure the data of **Coupling** through port 1 to port 3. (S31)
- Measure the data of **Transmission** through port 1 to port 4. (S41)
- Measure the data of **Isolation** through port 1 to port 2. (S21)
- Calculate the **Insertion Loss** and **Amplitude Balance** of coupler on the below power method formula.

	S-Parameter[dB]	Power Method[dB]
Coupling	S31	$10 \cdot \log\left(\frac{P_{cou}}{P_{in}}\right)$
Transmission Loss	S41	$10 \cdot \log\left(\frac{P_{out}}{P_{in}}\right)$
Isolation	S21	$10 \cdot \log\left(\frac{P_{iso}}{P_{in}}\right)$
Insertion Loss		$10 \cdot \log\left(\frac{P_{in}}{P_{cou} + P_{out}}\right)$
Amplitude Balance		$10 \cdot \log\left(\frac{P_{cou}}{\frac{P_{cou} + P_{out}}{2}}\right)$
Phase Balance	Phase _(S31) — Phase _(S41)	

P_{in} : Power of Input Port

P_{out} : Power of Output Port

P_{cou} : Power of Coupling Port

P_{iso} : Power of Isolated Port

10. Measurement board layout

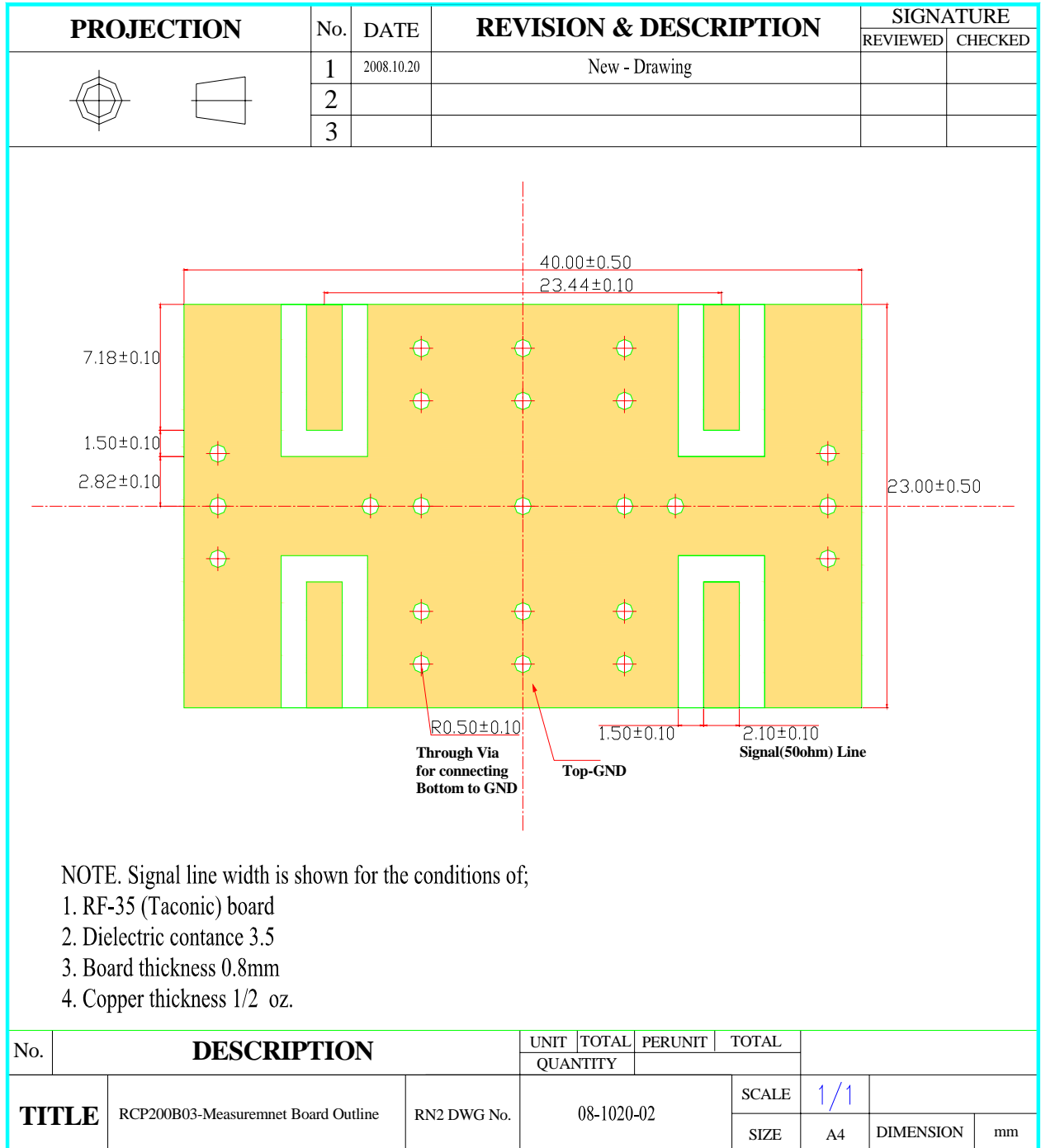

11. Recommended PCB layout and Solder mask pattern

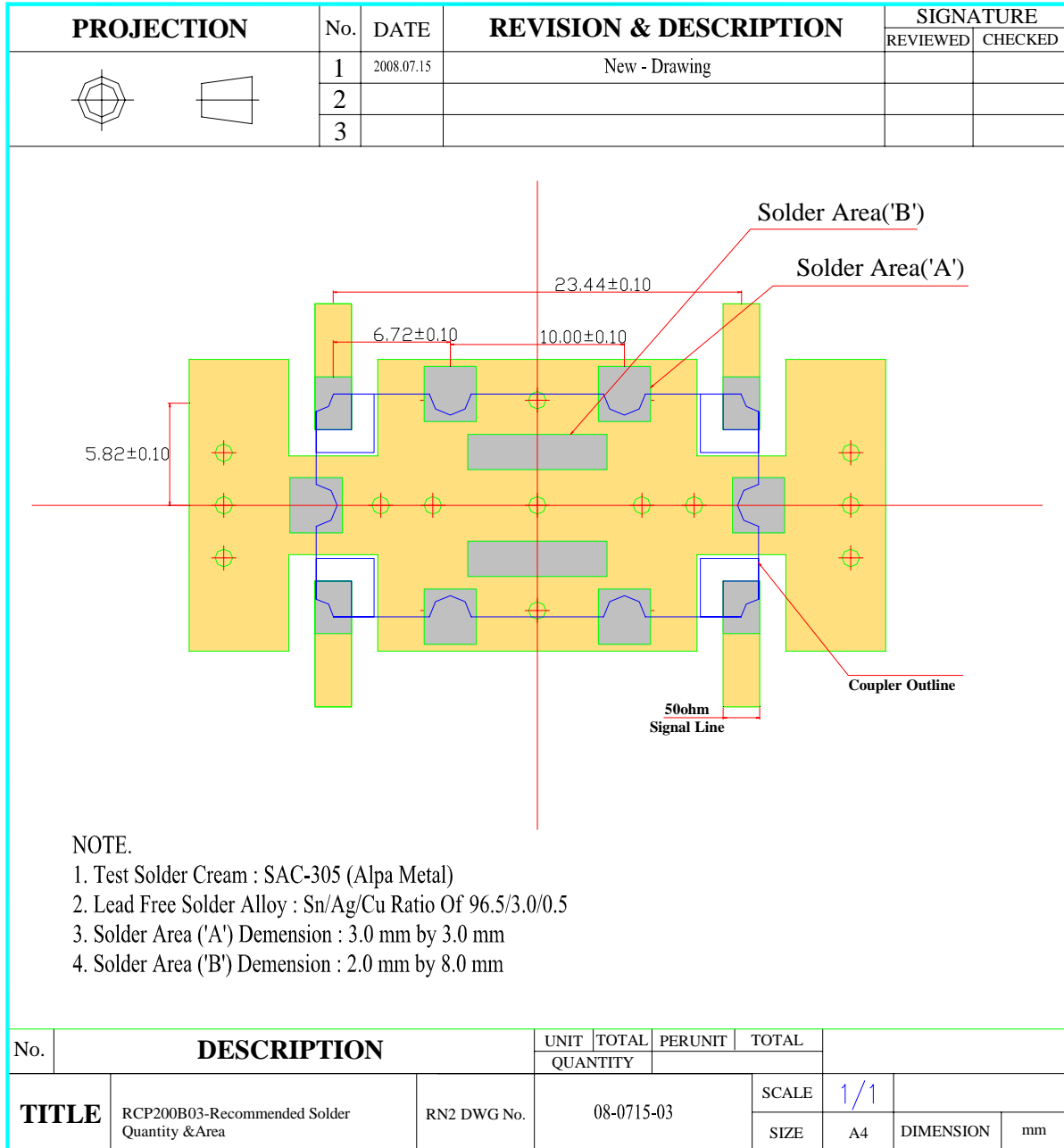

12. Reflow profile

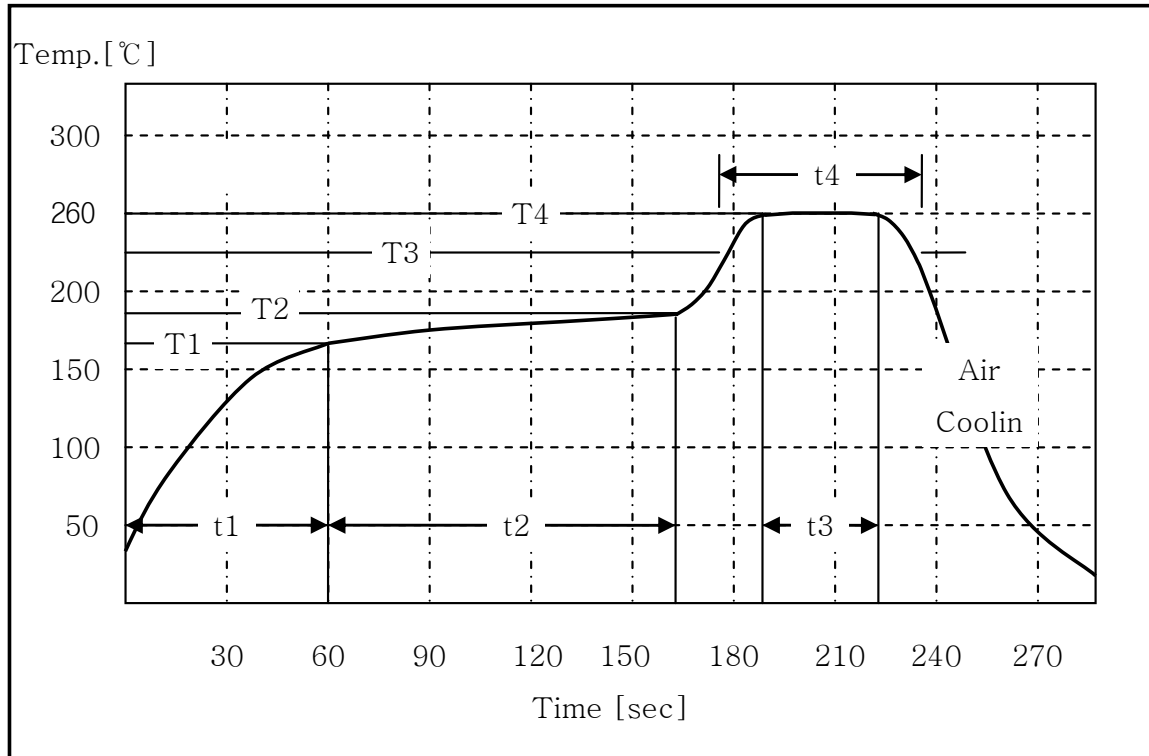

	Ramp Up	Pre-Heating	Peak	Soaking
Temp.[°C]	T1:160±5°C	T2:180±5°C	T4:260±5°C	T3:230±5°C
Time [sec]	t1:60±5sec	t2:100±15sec	t3:30±5sec	t4:60±10sec



13. Using note for LTCC Couplers

I. Be careful when transporting

- A. Excessive stress or shock may make products broken or cracked due to the nature of ceramics structure.
- B. The products cracked or damaged on terminals may have their property changed.

II. Be careful during storage

- A. Store the products in the temperature of $-55 \sim 125^{\circ}\text{C}$
- B. Keep the humidity at $45 \sim 75\%$ around the products.
- C. Prevent corrosive gas (Cl_2 , NH_3 , SO_x , NO_x , etc.) from contacting the products.
- D. It is recommended to use the products within 6 months of receipt. If the period exceeds 6 months, solderability may need to be verified.

III. Be careful when soldering

- A. All the ground terminals, IN and OUT pad of coupler should be soldered on the ground plane of the PCB.
- B. Products may be cracked or broken by uneven forces from a claw or suction device.
- C. Mechanical stress by any other devices may damage products when positioning them on PCB.
- D. A dropped product is recommended not to be used.
- E. Soldering must be carried out by the condition of specification sheet.
- F. Any couplers which are de-soldered from PCB should not be used again.

14. Packaging

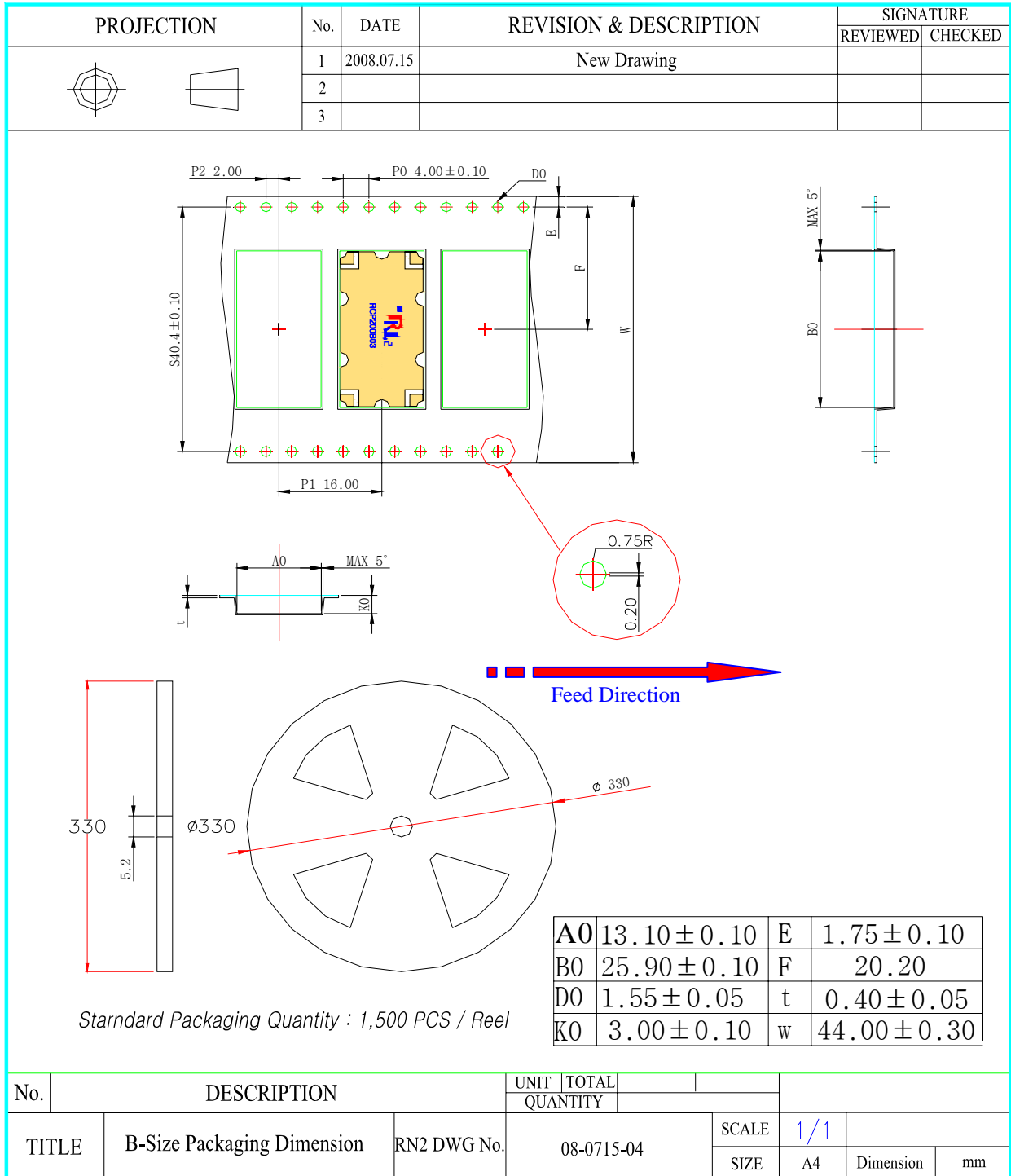

15. Environmental Reliability

ITEM	PROCEDURE	REQUIREMENTS/RESULT
Temperature Cycle (Thermal Shock)	1. One Cycle : 30 min Step1: 125 ± 5 °C for 15 min Step2: -55 ± 5 °C for 15 min 2. Approach high or low temperature in 10 seconds 3. Number of Cycles : 100 4. Normal temperature for 1 hour	1. Meet the electrical Specification after test
Solderability	1. Solder : 230 ± 5 °C for 5 ± 1 sec.	1. More than 85% of the I/O electrode pad shall be covered with solder.
Heat Resistance	1. Temperature : 100 ± 2 °C 2. Duration : 96 ± 2 hours	1. Meet the electrical Specification after test
Low Temp. Resistance	1. Temperature : -55 ± 5 °C 2. Duration : 24 ± 2 hours	1. Meet the electrical Specification after test
Vibration Resistance	1. Frequency: 5~ 15MHz 2. Acceleration : 10g 3. Sweep Time: 0.1 oct/min, 15min/axis 4. Axis : X, Y and Z direction	1. No appearance damage 2. Meet the electrical Specification after test
Humidity Resistance	1. One Cycle : Step1: increase Temperature $-25 \sim 65$ °C for 2hours with humidity 85% Step2: Maintain for 4 hour after increasing Humidity 90% to 95% Step3: Decrease Temperature 65 °C to 25 °C 2. Number of Cycles : 10 3. Maintain for 3hour after decreasing temperature -10 °C	1. Meet the electrical Specification after test
Drop Shock	1. Dropped onto hard wood from height of 50 cm for 5 times; each x, y and z direction except I/O direction.	1. No appearance damage 2. Meet the electrical Specification after test

16. RoHS test result

- RN2 Technologies warrants and represents as follows.

Test Report No. F690501/LF-CTSGP06-16067

Date: June 29, 2008

Page 2 of 3

Sample No. : GP06-16067.001
Sample Description : LTCC COUPLER
Style/Item No. : N/A
Comments : Materials are ceramics, Ag.

Heavy Metals

Test items	Unit	Test Method	MDL	Results
Cadmium(Cd)	mg/kg	US EPA 3050B(1996), US EPA 6010B(1996), ICP	0.5	N.D.
Lead (Pb)	mg/kg	US EPA 3050B(1996), US EPA 6010B(1996), ICP	5	N.D.
Mercury (Hg)	mg/kg	US EPA 3052(1996), US EPA 6010B(1996), ICP	2	N.D.
Hexavalent Chromium (Cr VI)	mg/kg	US EPA 3060A(1996), US EPA 7196A(1992), UV	1	N.D.

Flame Retardants-PBBs/PBDEs

Test items	Unit	Test Method	MDL	Results
Monobromobiphenyl	mg/kg	US EPA 3540C, GC/MS	5	N.D.
Dibromobiphenyl	mg/kg	US EPA 3540C, GC/MS	5	N.D.
Tribromobiphenyl	mg/kg	US EPA 3540C, GC/MS	5	N.D.
Tetrabromobiphenyl	mg/kg	US EPA 3540C, GC/MS	5	N.D.
Pentabromobiphenyl	mg/kg	US EPA 3540C, GC/MS	5	N.D.
Hexabromobiphenyl	mg/kg	US EPA 3540C, GC/MS	5	N.D.
Heptabromobiphenyl	mg/kg	US EPA 3540C, GC/MS	5	N.D.
Octabromobiphenyl	mg/kg	US EPA 3540C, GC/MS	5	N.D.
Nonabromobiphenyl	mg/kg	US EPA 3540C, GC/MS	5	N.D.
Decabromobiphenyl	mg/kg	US EPA 3540C, GC/MS	5	N.D.
Monobromodiphenyl ether	mg/kg	US EPA 3540C, GC/MS	5	N.D.
Dibromodiphenyl ether	mg/kg	US EPA 3540C, GC/MS	5	N.D.
Tribromodiphenyl ether	mg/kg	US EPA 3540C, GC/MS	5	N.D.
Tetrabromodiphenyl ether	mg/kg	US EPA 3540C, GC/MS	5	N.D.
Pentabromodiphenyl ether	mg/kg	US EPA 3540C, GC/MS	5	N.D.
Hexabromodiphenyl ether	mg/kg	US EPA 3540C, GC/MS	5	N.D.
Heptabromodiphenyl ether	mg/kg	US EPA 3540C, GC/MS	5	N.D.
Octabromodiphenyl ether	mg/kg	US EPA 3540C, GC/MS	5	N.D.
Nonabromodiphenyl ether	mg/kg	US EPA 3540C, GC/MS	5	N.D.
Decabromodiphenyl ether	mg/kg	US EPA 3540C, GC/MS	5	N.D.

NOTE: (1) N.D. = Not detected.(<MDL)
(2) ppm = mg/kg
(3) MDL = Method Detection Limit
(4) - = No regulation
(5) ** = Qualitative analysis (No Unit)
(6) Negative = Undetectable / Positive = Detectable

This Test Report is issued by the Company subject to its General Conditions of Service printed overleaf. Attention is drawn to the limitations of liability, indemnification and jurisdictional issues defined therein. The results shown in this test report refer only to the sample(s) tested unless otherwise stated. This Test Report cannot be reproduced, except in full, without prior written permission of the Company.