

PROTECTION PRODUCTS - RailClamp®
Description

The RailClamp family is a series of ultra low capacitance Transient Voltage Suppressors (TVS) designed to protect high speed data interfaces. This series has been specifically designed to protect sensitive components which are connected to high-speed data and transmission lines from overvoltage caused by ESD (electrostatic discharge), CDE (Cable Discharge Events), and EFT (electrical fast transients).

The RClamp®1521PQ has a maximum capacitance of only 0.5pF. This allows it to be used on circuits operating in excess of 3GHz without signal attenuation. They may be used to meet the ESD immunity requirements of IEC 61000-4-2, Level 4 ($\pm 15\text{kV}$ air, $\pm 8\text{kV}$ contact discharge).

The RClamp1521PQ is in a 2-pin, RoHS/WEEE compliant, SLP1006P2 package measuring 1.0 x 0.6 x 0.5mm. The leads are spaced at a pitch of 0.65mm and feature a lead-free finish. Each device will protect one high-speed line operating at 15 volts. It gives the designer the flexibility to protect single lines in applications where arrays are not practical. The combination of small size, low capacitance, and high ESD surge capability makes them ideal for use in applications such as cellular phones and high-power USB.

The RClamp1521PQ is qualified to AEC-Q100 Grade 1 for Automotive use.

Features

- ◆ Transient protection for data lines to **IEC 61000-4-2 (ESD) $\pm 15\text{kV}$ (air), $\pm 8\text{kV}$ (contact)**
IEC 61000-4-4 (EFT) 40A (tp = 5/50ns)
Cable Discharge Event (CDE)
- ◆ Ultra-small package (1.0 x 0.6 x 0.5mm).
- ◆ Protects one data or I/O line.
- ◆ Low capacitance: 0.3pF typical.
- ◆ Low clamping voltage.
- ◆ Low operating voltage: 15V.
- ◆ Solid-state silicon-avalanche technology.
- ◆ AEC-Q100 Grade1 Qualified.

Mechanical Characteristics

- ◆ SLP1006P2 package.
- ◆ Molding compound flammability rating: UL 94V-0.
- ◆ Marking: Marking code.
- ◆ Packaging : Tape and Reel.
- ◆ Lead Finish: NiPdAu.
- ◆ RoHS/WEEE Compliant

Applications

- ◆ Cellular Handsets & Accessories.
- ◆ USB Ports.
- ◆ PCI Express.
- ◆ Serial ATA.
- ◆ Automotive Applications.

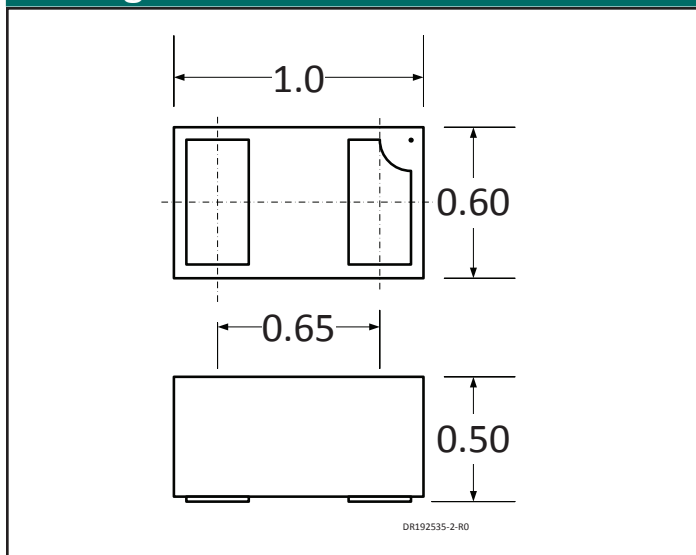
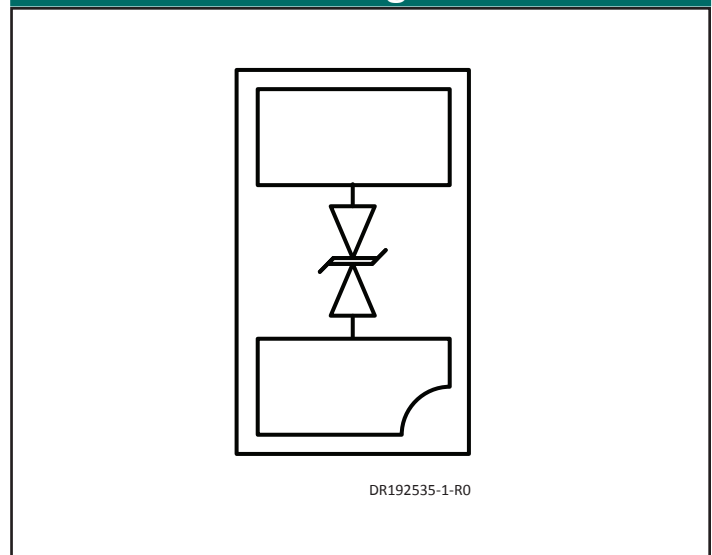
Package Dimensions

Schematic & Pin Configuration

PROTECTION PRODUCTS

Absolute Maximum Ratings

Rating	Symbol	Value	Units
Peak Pulse Power (tp = 8/20μs)	P _{PK}	120	W
Peak Pulse Current (tp = 8/20μs)	I _{PP}	4	A
ESD per IEC 61000-4-2 (Air)	V _{ESD}	±15	kV
ESD per IEC 61000-4-2 (Contact)		±8	
Operating Temperature	T _J	-40 to +125	°C
Storage Temperature	T _{STG}	-55 to +150	°C

Electrical Characteristics (T=25°C unless otherwise specified)

Parameter	Symbol	Conditions	Min.	Typ.	Max.	Units
Reverse Stand-Off Voltage	V _{RWM}	T = -40 to +125 °C			15	V
Reverse Breakdown Voltage	V _{BR}	I _t = 1mA T = -40 to +125 °C	16.7			V
Reverse Leakage Current	I _R	V _{RWM} = 15V,	T = 25 °C		1	uA
			T = 125 °C		5	
Clamping Voltage	V _C	I _{PP} = 1A, tp = 8/20μs			30	V
Clamping Voltage	V _C	I _{PP} = 4A, tp = 8/20μs			35	V
Junction Capacitance	C _J	V _R = 0V, f = 1MHz	T = 25 °C	0.30	0.50	pF
			T = 125 °C		1.00	

Non-Repetitive Peak Pulse Power vs. Pulse Time

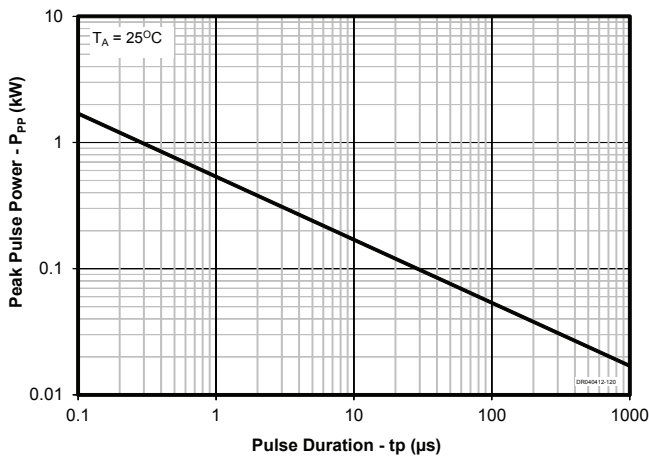

Power Derating Curve

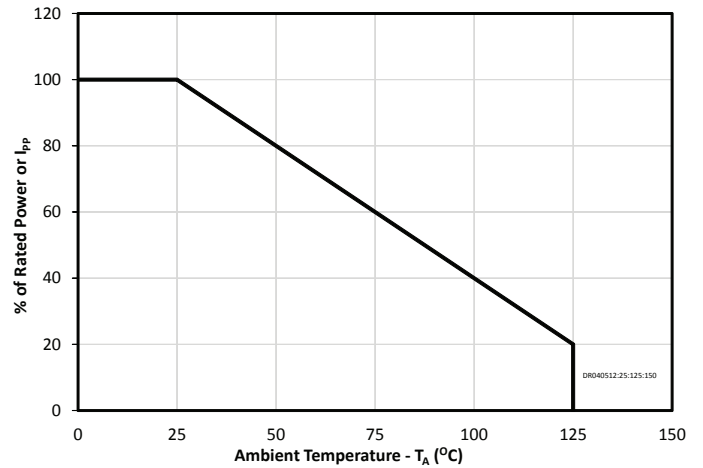

Reverse Leakage vs. Temperature

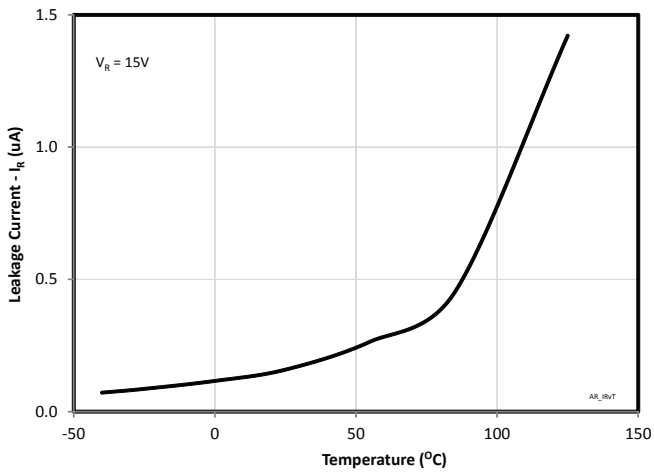

Reverse Leakage vs. Reverse Voltage

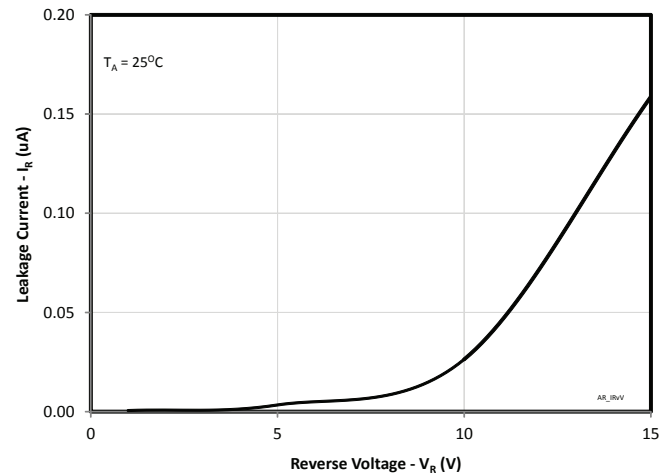

Capacitance vs. Temperature

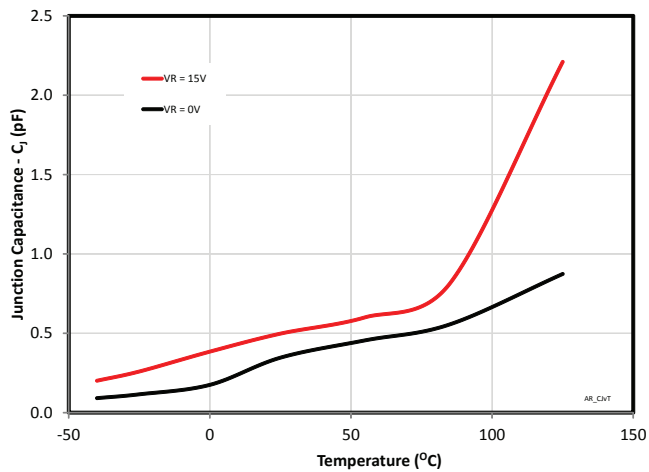

Breakdown Voltage vs. Temperature

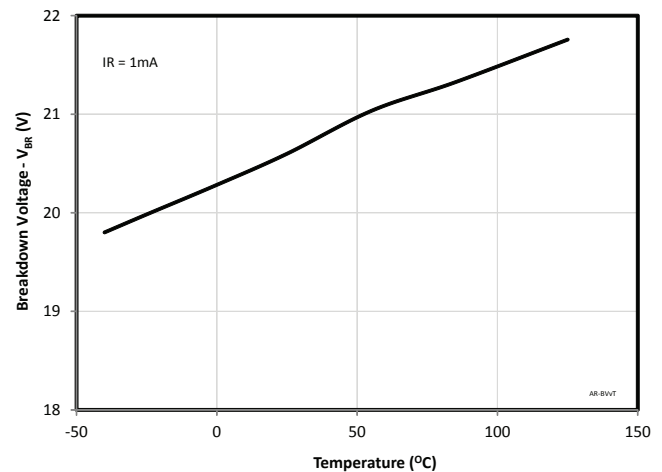

ESD Positive Clamp (8kV Contact per IEC 61000-4-2)

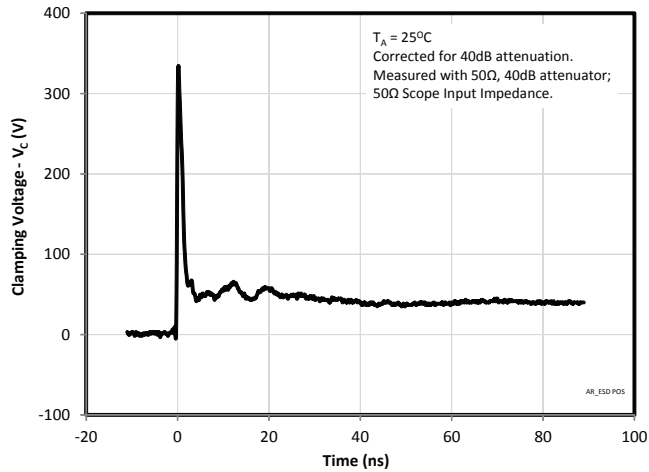

ESD Negative Clamp (8kV Contact per IEC 61000-4-2)

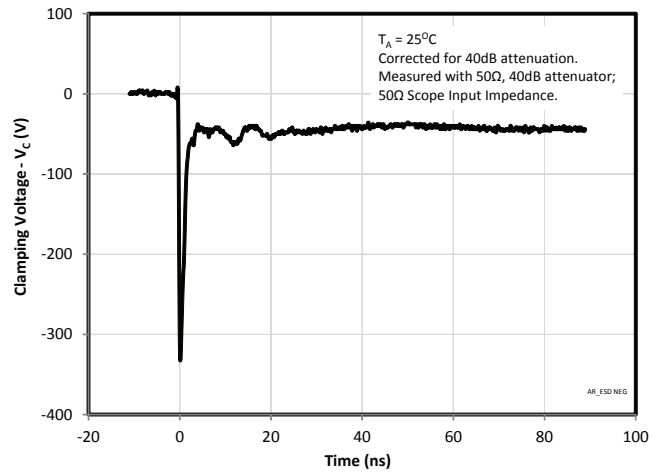

TLP IV Curve (Typical Either Direction)

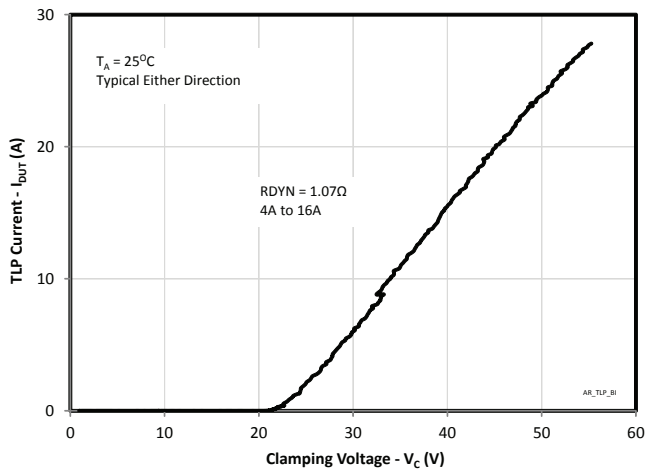

PROTECTION PRODUCTS**Applications Information****Device Connection Options**

These low capacitance TVS diodes are designed to provide common mode protection for one high-speed line or differential protection for one line pair. The device is bidirectional and may be used on lines where the signal polarity is positive and negative.

Circuit Board Layout Recommendations for Suppression of ESD.

Good circuit board layout is critical for the suppression of ESD induced transients. The following guidelines are recommended:

- ◆ Place the TVS near the input terminals or connectors to restrict transient coupling.
- ◆ Minimize the path length between the TVS and the protected line.
- ◆ Minimize all conductive loops including power and ground loops.
- ◆ The ESD transient return path to ground should be kept as short as possible.
- ◆ Never run critical signals near board edges.
- ◆ Use ground planes whenever possible.

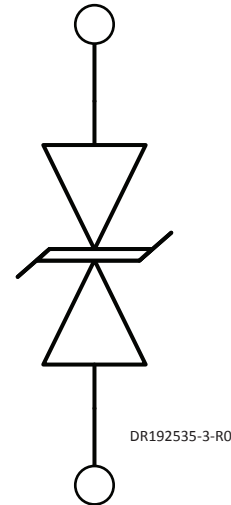
Equivalent Circuit Diagram

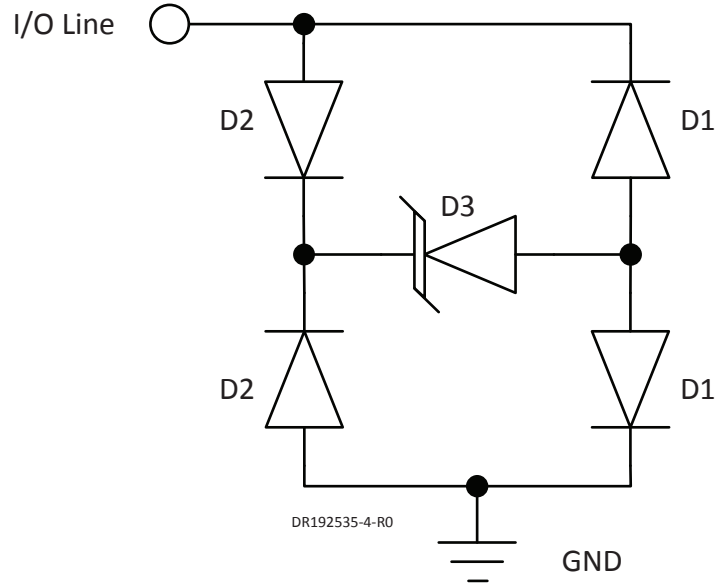

RClamp1521PQ Spice Model

RClamp1521PQ Spice Parameters				
Parameter	Unit	D1 (LCRD)	D2 (LCRD)	D3 (TVS)
IS	(A)	1.0E-20	1.0E-20	2.0E-12
BV	(V)	100	100	19.5
VJ	(V)	0.7	0.7	0.6
RS	(Ohm)	0.458	0.89	0.8
IBV	(A)	1E-3	1E-3	1E-3
CJO	(F)	0.4E-12	0.4E-12	56E-12
TT	(s)	2.541E-9	2.541E-9	2.541E-9
M	--	0.01	0.01	0.23
N	--	1.1	1.1	1.1
EG	(eV)	1.11	1.11	1.11

PROTECTION PRODUCTS

Outline Drawing - {Insert Package Type}

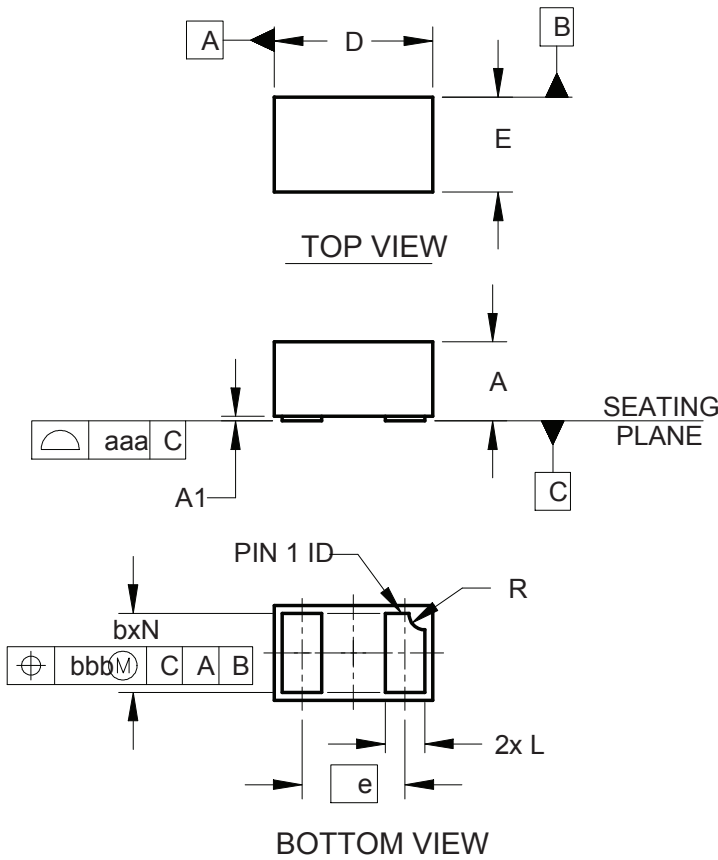

DIMENSIONS						
DIM	INCHES			MILLIMETERS		
	MIN	NOM	MAX	MIN	NOM	MAX
A	.016	.020	.022	0.40	0.50	0.55
A1	.000	.001	.002	0.00	0.03	0.05
b	.018	.020	.022	0.45	0.50	0.55
D	.035	.039	.043	0.90	1.00	1.10
E	.020	.024	.028	0.50	0.60	0.70
e	.026 BSC			0.65 BSC		
L	.008	.010	.012	0.20	0.25	0.30
R	.002	.004	.006	0.05	0.10	0.15
N	2			2		
aaa	.003			0.08		
bbb	.004			0.10		

DR192536-1-R0

- NOTES:
1. CONTROLLING DIMENSIONS ARE IN MILLIMETERS (ANGLES IN DEGREES).

Land Pattern - {Insert Package Type}

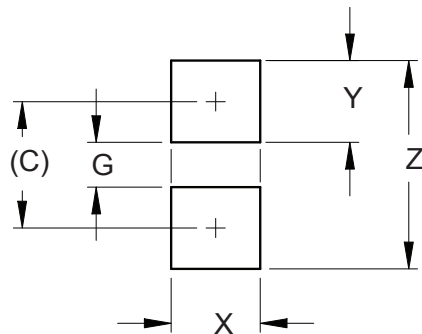

DIMENSIONS		
DIM	INCHES	MILLIMETERS
C	(.033)	(0.85)
G	.012	0.30
X	.024	0.60
Y	.022	0.55
Z	.055	1.40

DR192536-2-R0

- NOTES:
1. CONTROLLING DIMENSIONS ARE IN MILLIMETERS (ANGLES IN DEGREES).
 2. THIS LAND PATTERN IS FOR REFERENCE PURPOSES ONLY. CONSULT YOUR MANUFACTURING GROUP TO ENSURE YOUR COMPANY'S MANUFACTURING GUIDELINES ARE MET.

PROTECTION PRODUCTS

Marking

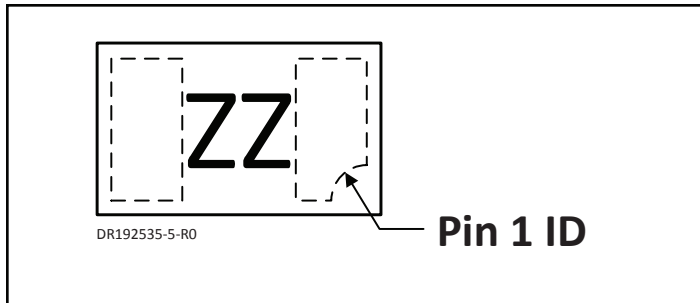

Ordering Information

Part Number	Qty per Reel	Reel Size
RClamp1521PQTCT	3000	7 Inch

Note: Lead finish is lead-free NiPdAu
 RailClamp and RClamp are marks of Semtech Corporation.

Tape and Reel Specification

A0	B0	K0	B1	D	D1	E	F	K	P	P0	P2	t	W
0.69 ±0.10	1.19 ±0.10	0.66 ±0.10	Not Spec'd	1.50 +0.1 -0.0	Not Spec'd	1.75 ±0.10	3.50 ±0.05	Not Spec'd	4.00 ±0.10	4.00 ±0.10	2.00 ±0.05	Not Spec'd	8.0 +0.3 -0.1

Ref KCT00078 Rev0

Contact Information

Semtech Corporation
 Protection Products Division
 200 Flynn Rd., Camarillo, CA 93012
 Phone: (805)498-2111 FAX (805)498-3804

Date	Description	By
1/8/2013	Raised from PM Document RClamp1521P.pmd Rev 8/22/07	DJR
1/30/2013	Released to PLM as Preliminary	DJR
2/1/2013	Corrected p1. date (was 2012); Added High temp. parameters to Electrical Characteristics table.	DJR
3/1/2013	Changed 8/20 Clamping voltage. WAS 28V @ 1A; 30V @ 4A: IS 30V @ 1A; 35V @ 4A: Reason necessary for yield.	DJR
3/15/2013	Added ESD and TLP Curves, raised to Final; Released to PLM as Final	DJR