

PROTECTION PRODUCTS - RailClamp®

Description

RailClamp® TVS arrays are ultra low capacitance ESD protection devices designed to protect high speed data interfaces. This series has been specifically engineered to protect sensitive components which are connected to high-speed data and transmission lines from over-voltage caused by **ESD** (electrostatic discharge), **CDE** (Cable Discharge Events), and **EFT** (electrical fast transients).

The RClamp®7524T will protect four lines or two differential pairs. Each line has a maximum capacitance of only 0.60pF between any I/O pin and ground. This allows it to be used on circuits operating in excess of 5GHz without signal attenuation. They feature high maximum ESD withstand voltage of +/- 25kV contact, +/-30kV air discharge per IEC 61000-4-2.

The RClamp7524T is in a 5-pin SLP1308N5T package. It measures 1.3 x 0.8mm with a nominal height of 0.40mm. The innovative flow through package design simplifies pcb layout and allows matched trace lengths for constant impedance between high speed differential lines.

The combination of small size, low capacitance, and high level of ESD protection makes this device a flexible solution for applications such as HDMI, MHL, MDDI, and eDP interfaces.

Features

- ◆ ESD protection for high-speed data lines to **IEC 61000-4-2 (ESD) ±30kV (air), ±25kV (contact)**
- ◆ **IEC 61000-4-5 (Lightning) 5A (8/20µs)**
- ◆ **IEC 61000-4-4 (EFT) 40A (5/50ns)**
- ◆ Package design optimized for high speed lines
- ◆ Flow-Through design
- ◆ Protects four high-speed lines
- ◆ Low capacitance: **0.60pF** Maximum (I/O to Ground)
- ◆ Low ESD clamping voltage
- ◆ Low dynamic resistance: 0.50 Ohms (Typ)
- ◆ Solid-state silicon-avalanche technology

Mechanical Characteristics

- ◆ SLP1308N5T 5-pin package (1.3 x 0.8 x 0.40mm)
- ◆ Pb-Free, Halogen Free, RoHS/WEEE Compliant
- ◆ Lead Pitch: 0.45mm
- ◆ Lead finish: NiPdAu
- ◆ Marking: Marking Code
- ◆ Packaging: Tape and Reel

Applications

- ◆ HDMI 1.3 and HDMI 1.4
- ◆ V-By-One
- ◆ USB 3.0
- ◆ MHL
- ◆ eDP
- ◆ LVDS Interfaces
- ◆ eSATA Interfaces

Dimensions

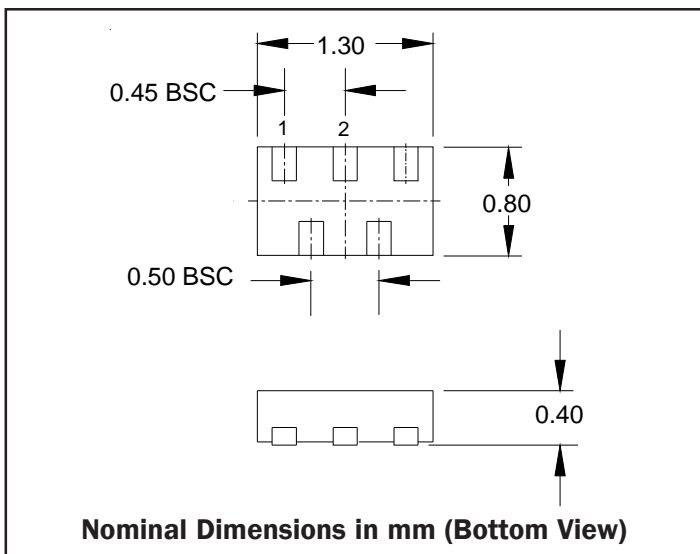

Circuit Diagram

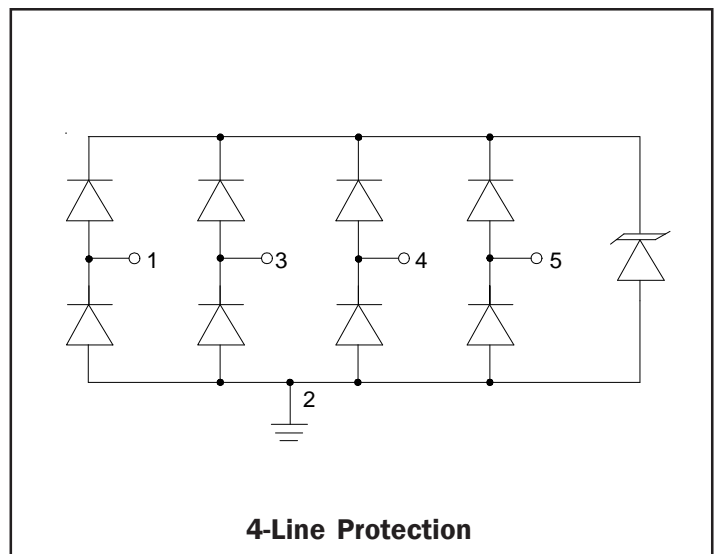

PROTECTION PRODUCTS
Absolute Maximum Rating

Rating	Symbol	Value	Units
Peak Pulse Power (tp = 8/20μs)	P_{pk}	75	Watts
Peak Pulse Current (tp = 8/20μs)	I_{pp}	5	A
ESD per IEC 61000-4-2 (Air) ¹ ESD per IEC 61000-4-2 (Contact) ¹	V_{ESD}	+/- 30 +/- 25	kV
Operating Temperature	T_J	-55 to +125	°C
Storage Temperature	T_{STG}	-55 to +150	°C

Electrical Characteristics (T=25°C)

Parameter	Symbol	Conditions	Minimum	Typical	Maximum	Units
Reverse Stand-Off Voltage	V_{RWM}	Any I/O to GND			5	V
Reverse Breakdown Voltage	V_{BR}	$I_L = 1mA$, Any I/O to GND	6.5	9	11	V
Reverse Leakage Current	I_R	$V_{RWM} = 5.0V$, Any I/O to GND		0.005	0.100	μA
Clamping Voltage	V_C	$I_{pp} = 1A$, tp = 8/20μs Any I/O to GND			12	V
Clamping Voltage	V_C	$I_{pp} = 5A$, tp = 8/20μs Any I/O to GND			15	V
ESD Clamping Voltage ²	V_C	IPP = 4A, t1p = 0.2/100ns		11		V
ESD Clamping Voltage ²	V_C	IPP = 16A, t1p = 0.2/100ns		17		V
Dynamic Resistance ³	R_D	tp = 100ns		0.50		Ohms
Junction Capacitance	C_j	$V_R = 0V$, f = 1MHz, Any I/O to GND		0.50	0.60	pF
		$V_R = 0V$, f = 1MHz, Between I/O pins		0.25	0.4	pF

Notes

- 1) Measured with a 20dB attenuator, 50 Ohm scope input impedance, 2GHz bandwidth. ESD gun return path connected to ESD ground plane.
- 2) Transmission Line Pulse Test (TLP) Settings: $t_p = 100ns$, $t_r = 0.2ns$, I_{TLP} and V_{TLP} averaging window: $t_1 = 70ns$ to $t_2 = 90ns$.
- 3) Dynamic resistance calculated from $I_{TLP} = 4A$ to $I_{TLP} = 16A$

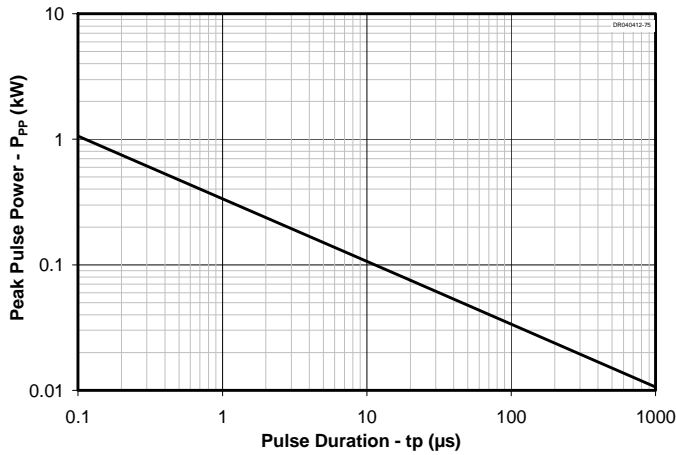
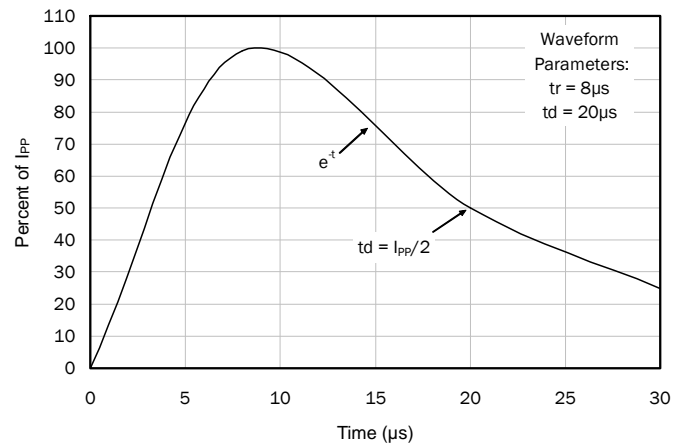
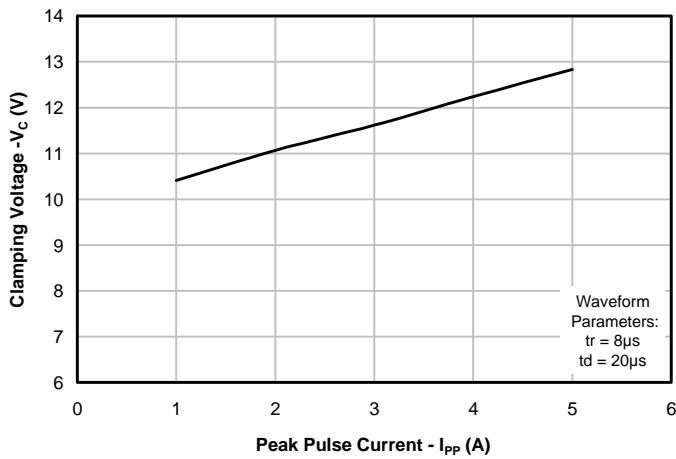
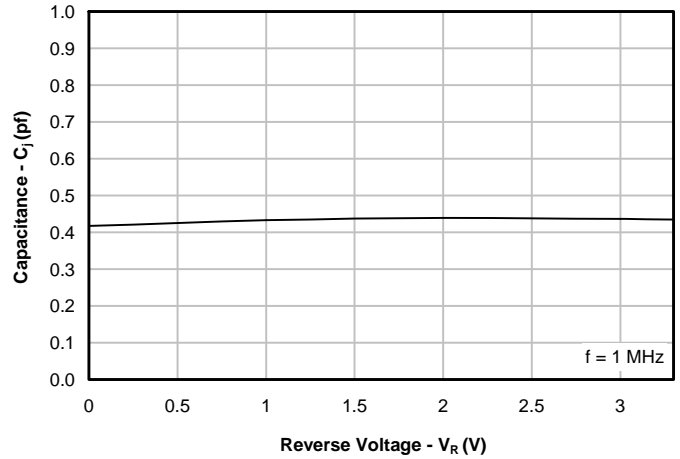
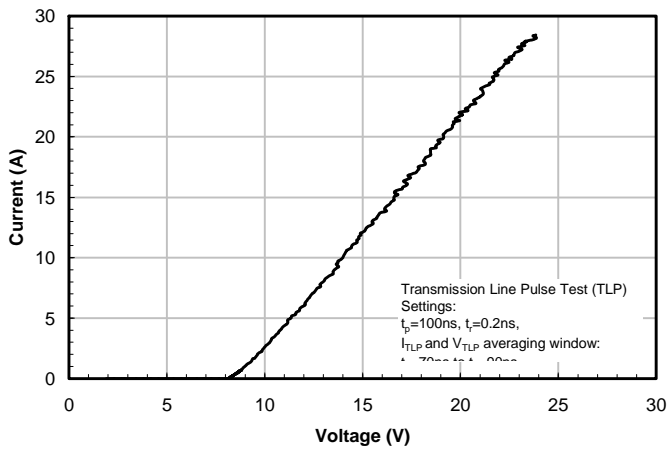
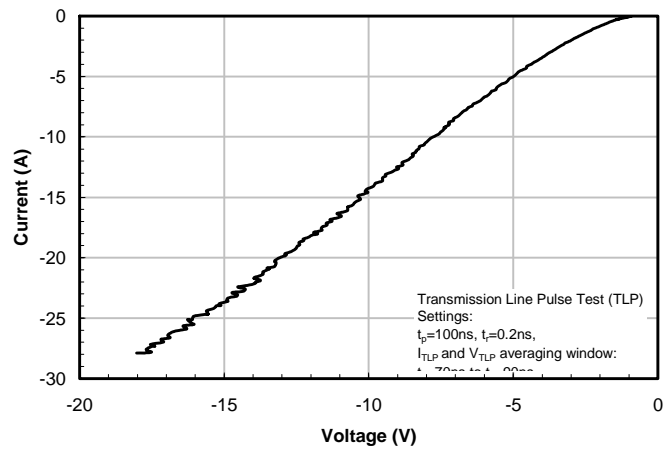
PROTECTION PRODUCTS
Typical Characteristics
Non-Repetitive Peak Pulse Power vs. Pulse Time

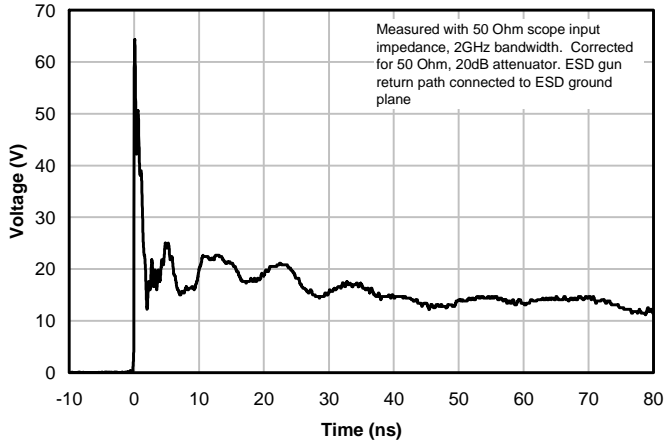
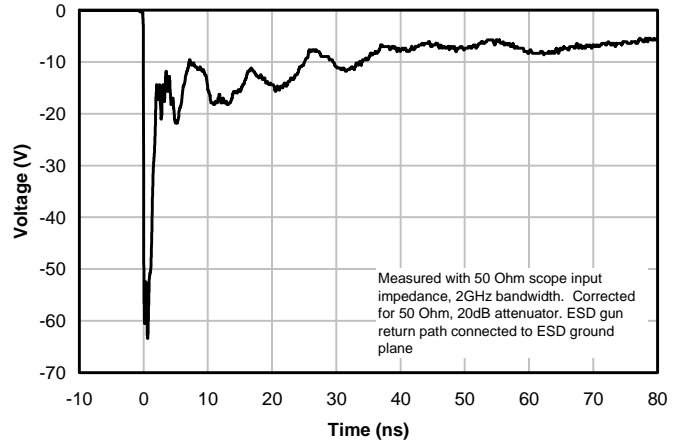
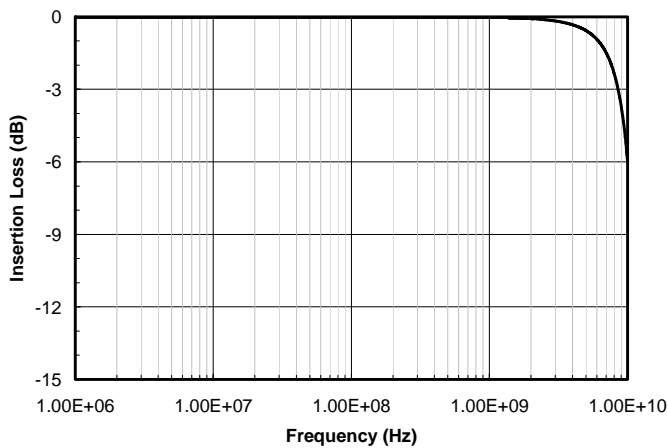
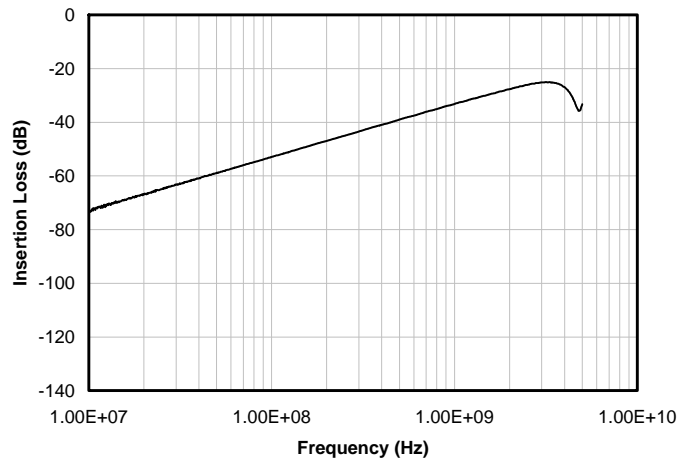
8/20us Pulse Waveform

**Clamping Voltage vs. Peak Pulse Current
(Between any I/O and Ground)**

**Junction Capacitance vs. Reverse Voltage
(Between any I/O and Ground)**

TLP Characteristic (Positive)

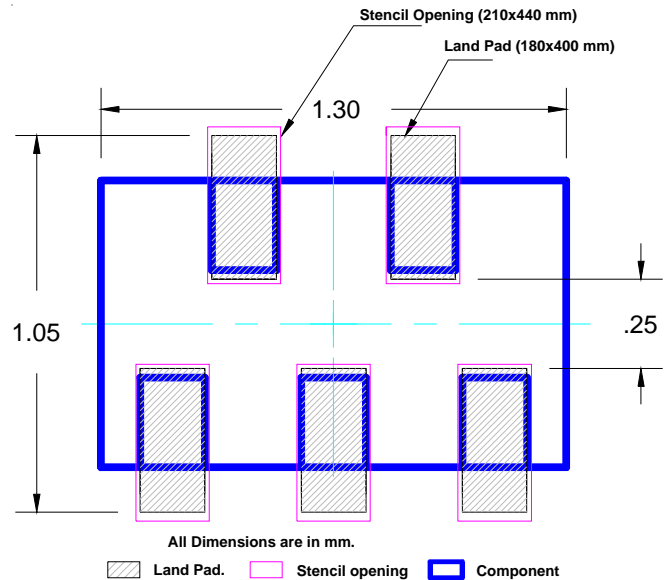
TLP Characteristic (Negative)

PROTECTION PRODUCTS
Typical Characteristics (Con't)
**ESD Clamping (+8kV Contact per IEC 61000-4-2)
(Between any I/O and Ground)**

**ESD Clamping (-8kV Contact per IEC 61000-4-2)
(Between any I/O and Ground)**

Typical Insertion Loss S21

Analog Crosstalk

PROTECTION PRODUCTS
Applications Information
Assembly Guidelines

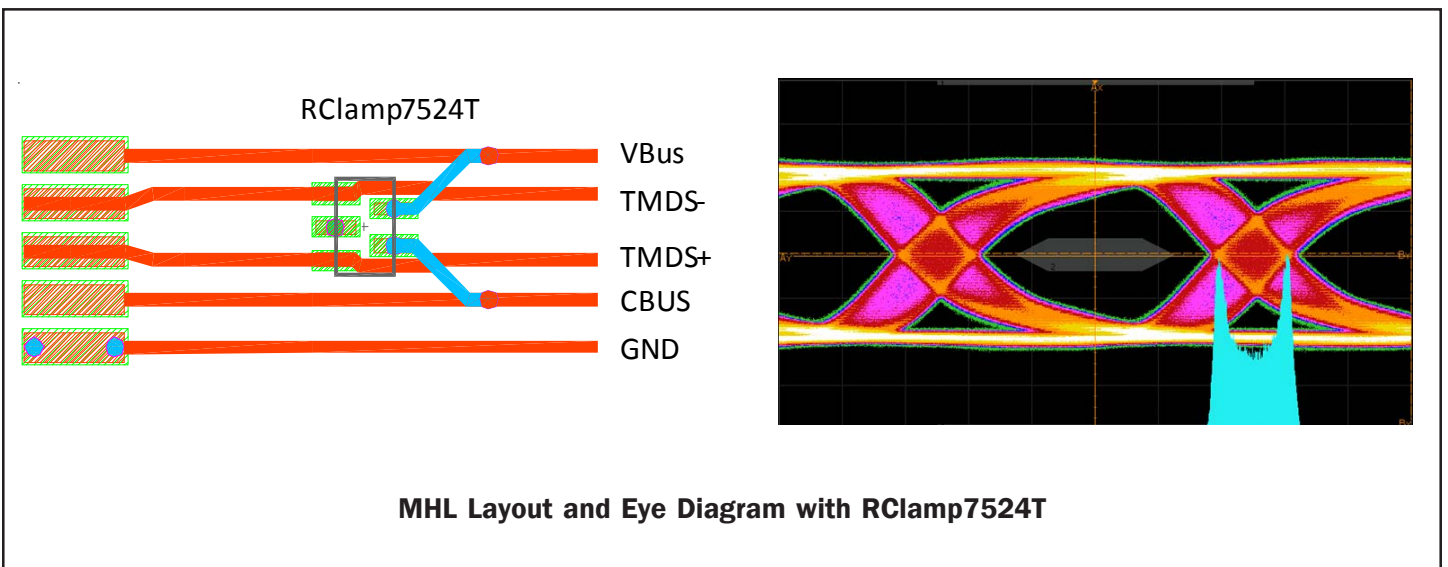
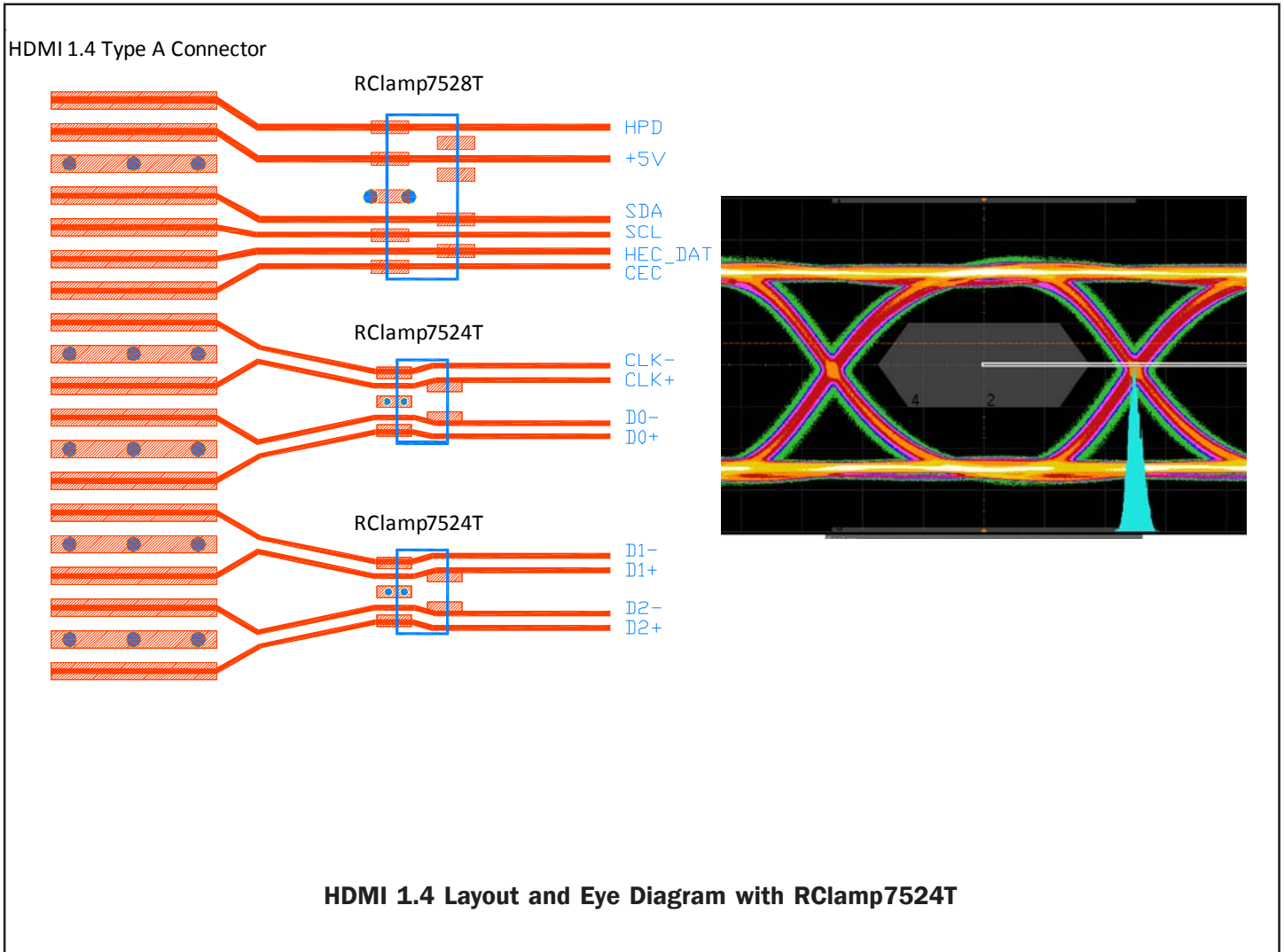
The small size of this device means that some care must be taken during the mounting process to insure reliable solder joint. The table below provides Semtech's recommended assembly guidelines for mounting this device. The figure at the right details Semtech's recommended aperture based on the below recommendations. Note that these are only recommendations and should serve only as a starting point for design since there are many factors that affect the assembly process. The exact manufacturing parameters will require some experimentation to get the desired solder application.

Assembly Parameter	Recommendation
Solder Stencil Design	Laser cut, Electro-polished
Aperture shape	Rectangular
Solder Stencil Thickness	0.100 mm (0.004")
Solder Paste Type	Type 4 size sphere or smaller
Solder Reflow Profile	Per JEDEC J-STD-020
PCB Solder Pad Design	Non-Solder mask defined
PCB Pad Finish	OSP OR NiAu

Recommended Mounting Pattern

PROTECTION PRODUCTS
Applications Information

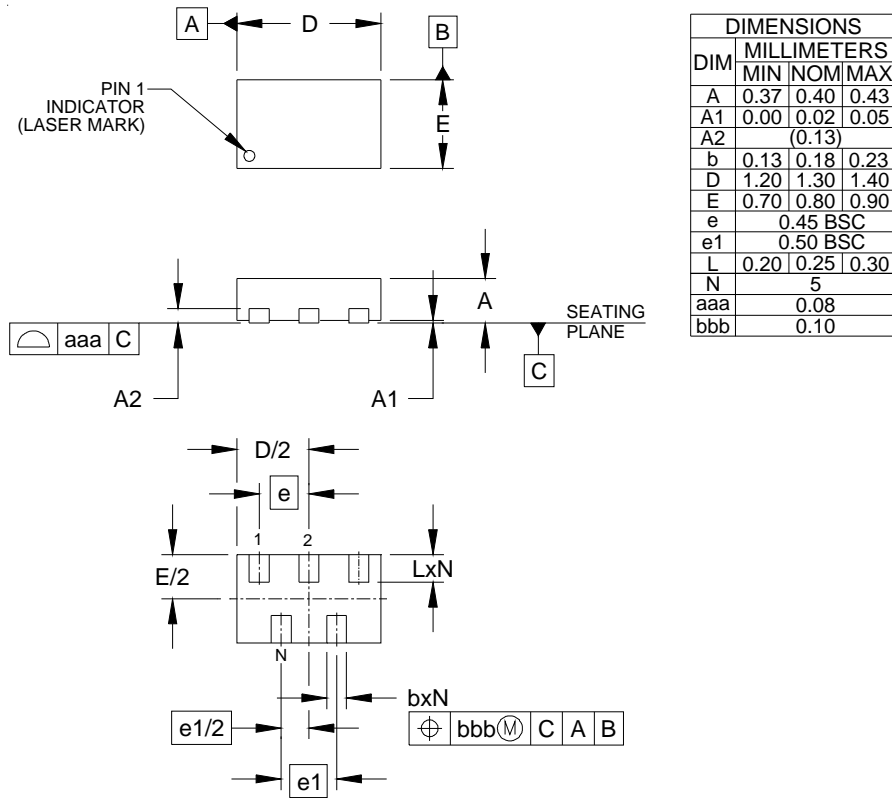
PROTECTION PRODUCTS
Outline Drawing - SLP1308N5T

NOTES:

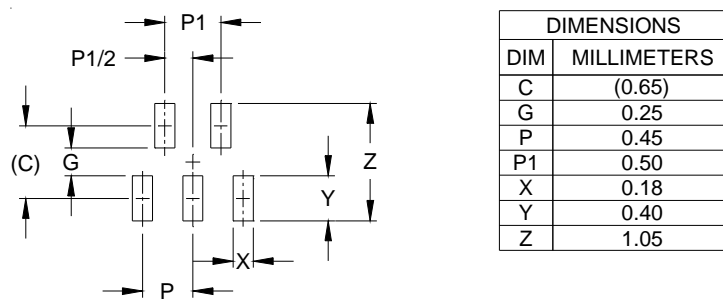
1. CONTROLLING DIMENSIONS ARE IN MILLIMETERS (ANGLES IN DEGREES).

Land Pattern - SLP1308N5T

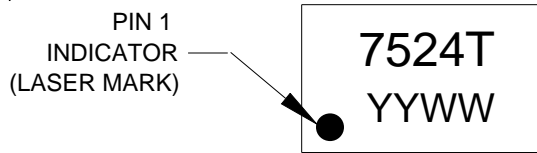
NOTES:

1. CONTROLLING DIMENSIONS ARE IN MILLIMETERS (ANGLES IN DEGREES).
2. THIS LAND PATTERN IS FOR REFERENCE PURPOSES ONLY.
CONSULT YOUR MANUFACTURING GROUP TO ENSURE YOUR COMPANY'S MANUFACTURING GUIDELINES ARE MET.

PROTECTION PRODUCTS
Marking Code

Ordering Information

Part Number	Qty per Reel	Reel Size
RClamp7524T.TNT	10,000	7 Inch

YYWW = Date Code

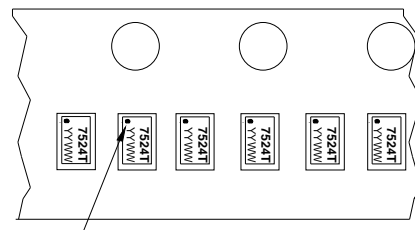
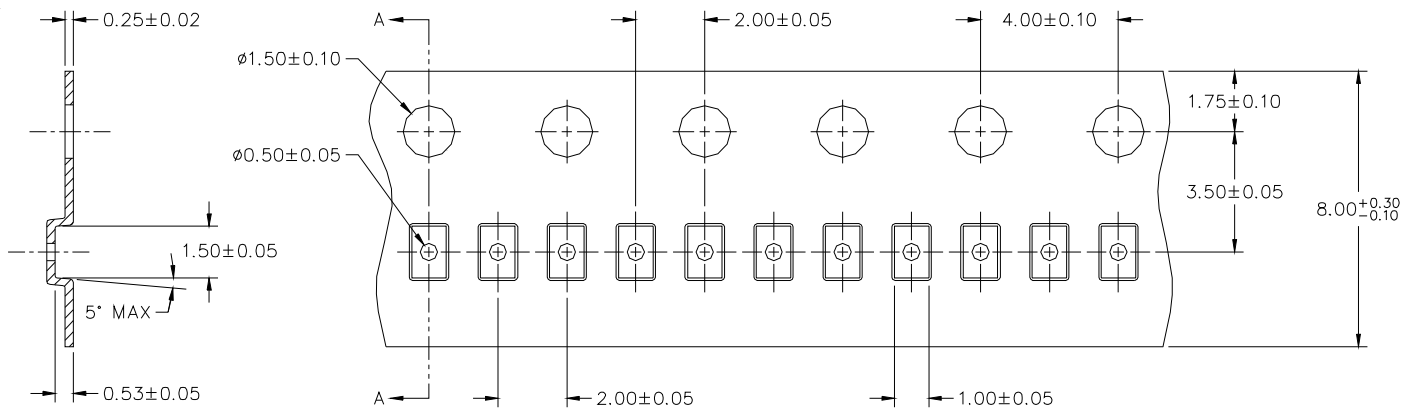
RailClamp and RClamp are trademarks of Semtech Corporation.

Carrier Tape Specification

Pin 1 Location (Towards Sprocket Holes)

→
User Direction of feed

Device Orientation in Tape

Contact Information

Semtech Corporation
Protection Products Division
200 Flynn Road, Camarillo, CA 93012
Phone: (805)498-2111 FAX (805)498-3804