

< Silicon RF Power MOS FET (Discrete) >

RD02LUS2

RoHS Compliance, Silicon MOSFET Power Transistor 470MHz, 2W, 3.6V

DESCRIPTION

RD02LUS2 is a MOS FET type transistor designed for VHF/UHF RF driver device.

FEATURES

- High Power Gain and High Efficiency
 $P_{out} > 2.0W$, $G_p = 10dB$, Drain Eff. = 60%typ
@ $f = 470MHz$, $V_{DS} = 3.6V$, $I_{dq} = 140mA$, $P_{in} = 0.2W$
- Integrated gate protection diode

APPLICATION

For driver stage of high power amplifiers in VHF/UHF Band mobile radio sets.

RoHS COMPLIANT

RD02LUS2-501, T513 is EU RoHS compliant. This product includes the lead in high melting temperature type solders.

However, it is applicable to the following exceptions of RoHS Directions.

- Lead in high melting temperature type solders (i.e. tin-lead solder alloys containing more than 85% lead.)

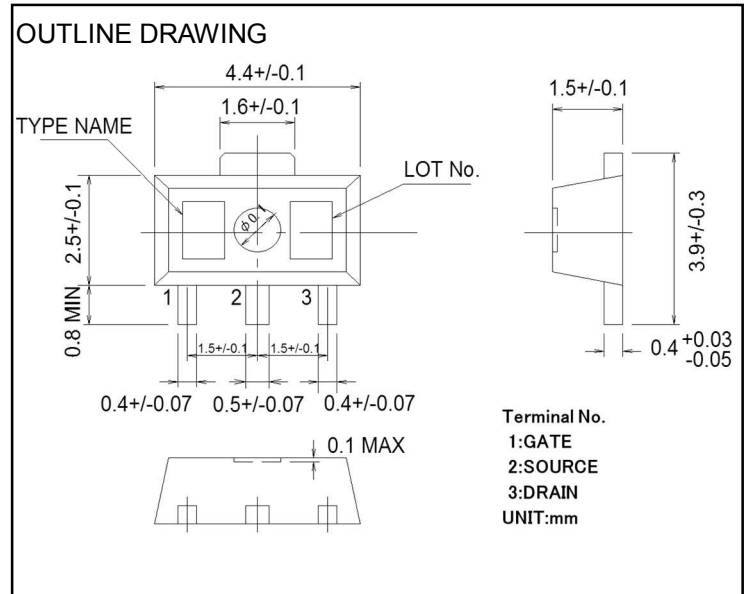

ABSOLUTE MAXIMUM RATINGS

($T_c = 25^\circ C$ UNLESS OTHERWISE NOTED)

SYMBOL	PARAMETER	CONDITIONS	RATINGS	UNIT
VDSS	Drain to source voltage	$V_{GS} = 0V$	25	V
VGSS	Gate to source voltage	$V_{DS} = 0V$	-5/+10	V
Pch*	Channel dissipation	$T_c = 25^\circ C$	15.6	W
Pin	Input Power	$Z_g = Z_l = 50\Omega$	400	mW
ID	Drain Current	-	2.2	A
Tch	Channel Temperature	-	150	$^\circ C$
Tstg	Storage temperature	-	-40 to +125	$^\circ C$

Note: Above parameters are guaranteed independently.

* Theoretical value in case of mounted on infinite heat sink.

ELECTRICAL CHARACTERISTICS

($T_c = 25^\circ C$, UNLESS OTHERWISE NOTED)

SYMBOL	PARAMETER	CONDITIONS	LIMITS			UNIT
			MIN	TYP	MAX	
I_{DSS}	Zero gate voltage drain current	$V_{DS} = 17V$, $V_{GS} = 0V$	-	-	50	μA
I_{GSS}	Gate to source leak current	$V_{GS} = 10V$, $V_{DS} = 0V$	-	-	1	μA
V_{th}	Gate threshold Voltage	$V_{DS} = 3.6V$, $I_{DS} = 1mA$	0.5	1.0	1.5	V
P_{out}	Output power	$V_{DD} = 3.6V$, $P_{in} = 0.2W$	-	2.3	-	W
η_D	Drain efficiency	$f = 470MHz$, $I_{dq} = 140mA$	-	70	-	%

Note: Above parameters, ratings, limits and conditions are subject to change.

TEMPERATURE CHARACTERISTICS

($T_c = 25^\circ C$ UNLESS OTHERWISE NOTED)

SYMBOL	PARAMETER	CONDITIONS	LIMITS			UNIT
			MIN	TYP	MAX	
$R_{th(j-c)}$	Thermal Resistance	Junction to Case	-	2.4	8.0	$^\circ C / W$

RD02LUS2

RoHS Compliance, Silicon MOSFET Power Transistor 470MHz, 2W, 3.6V

TYPICAL CHARACTERISTICS

(These are only typical curves and devices are not necessarily guaranteed at these curves.)

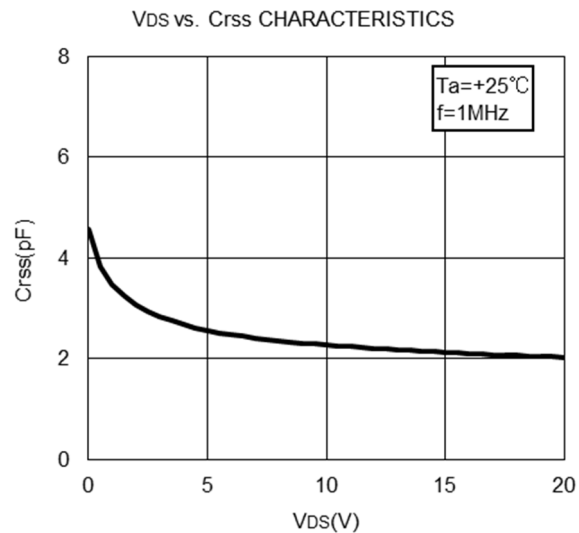
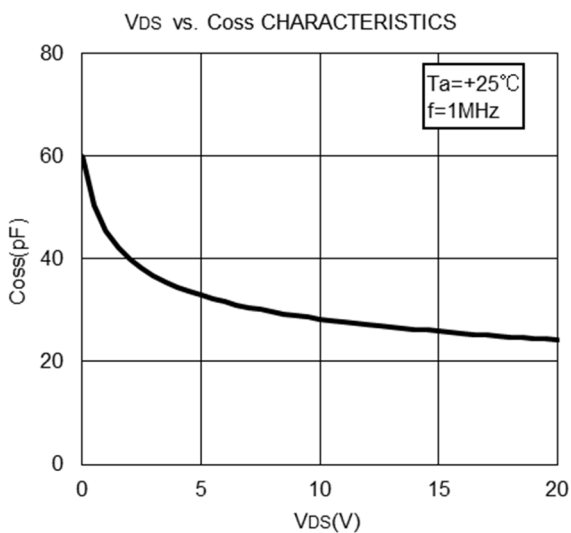
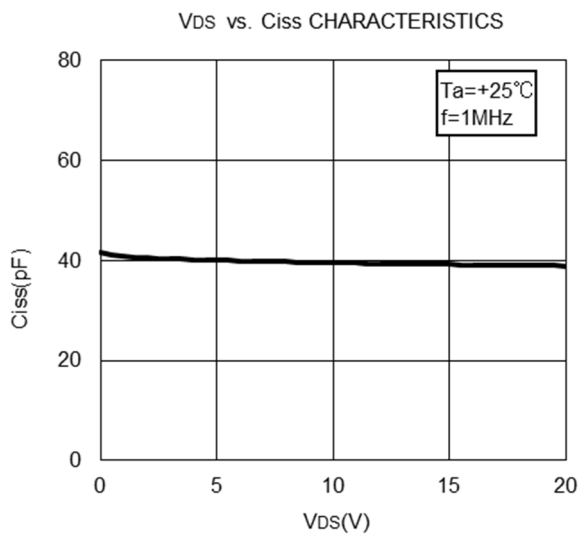
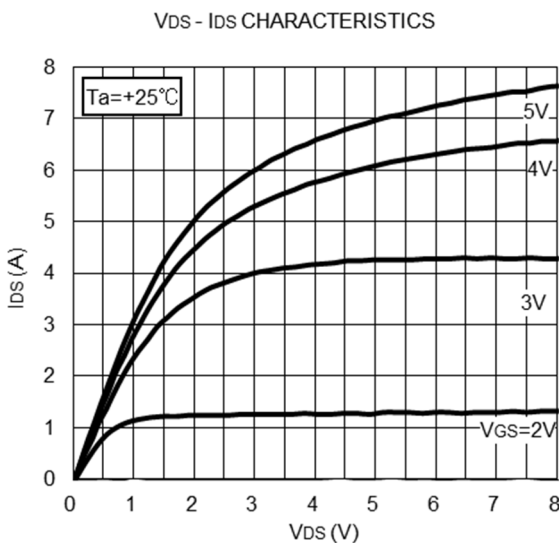
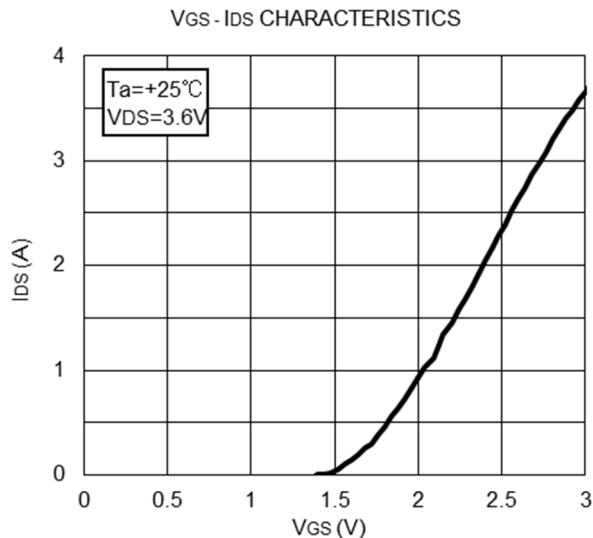
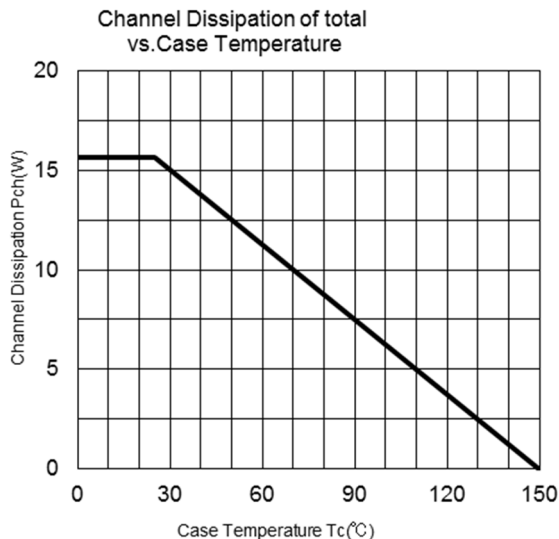

RD02LUS2

RoHS Compliance, Silicon MOSFET Power Transistor 470MHz, 2W, 3.6V

TYPICAL CHARACTERISTICS

(These are only typical curves and devices are not necessarily guaranteed at these curves.)

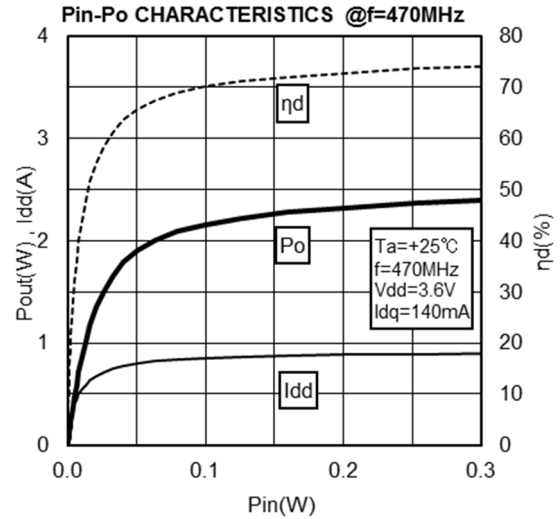
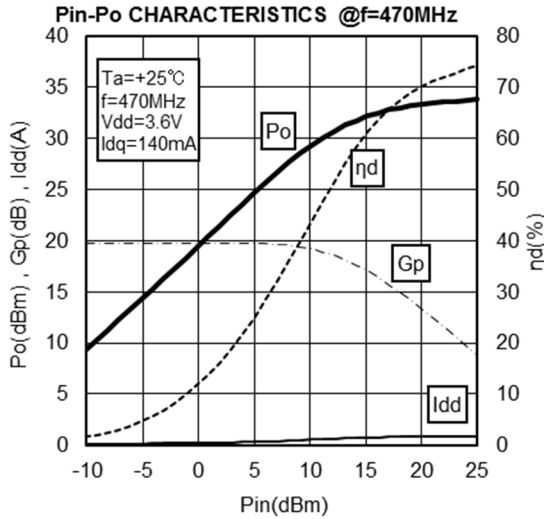

EQUIVALENT CIRCUITRY for UHF CIRCUIT (f=470MHz)

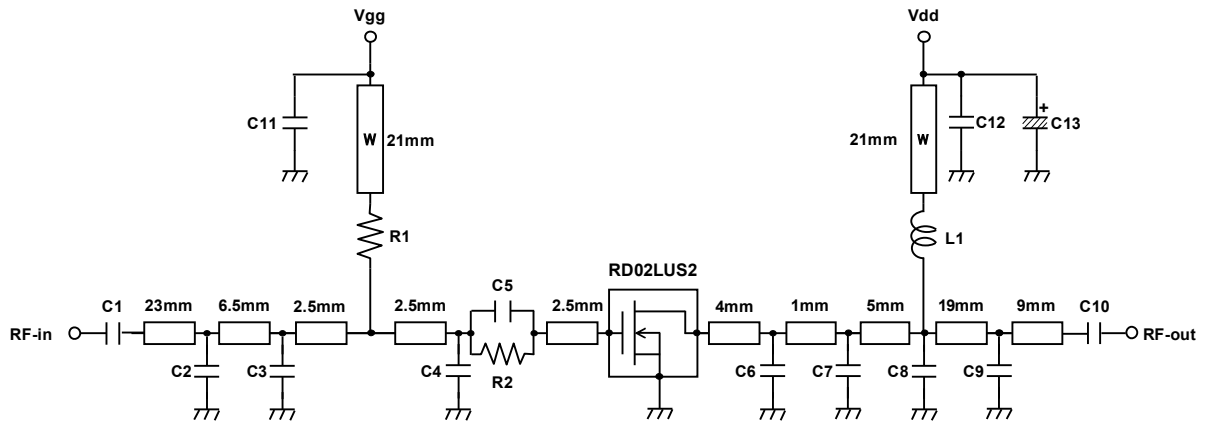

<Note>
 Board material: Glass-Epoxy Substrate(εr=4.8, t=0.8mm)
 Micro strip line width=1.3mm / 50 Ω
 W line width=1.0mm

Part	Description	Part number	Manufacturer
C1, C10	200 pF	GRM2162C1H201JA01	MURATA MANUFACTURING CO.
C2	36 pF	GRM2162C1H360JZ01	MURATA MANUFACTURING CO.
C3	3 pF	GRM2162C1H3R0JA01	MURATA MANUFACTURING CO.
C4	43 pF	GRM2162C1H430JZ01	MURATA MANUFACTURING CO.
C5	100 pF	GRM1882C1H101JA01	MURATA MANUFACTURING CO.
C6, C7	24 pF	GQM2195C2E240JB12	MURATA MANUFACTURING CO.
C8	3 pF	GQM2195C2E3R0CB12	MURATA MANUFACTURING CO.
C9	10 pF	GQM2195C2E100JB12	MURATA MANUFACTURING CO.
C11, C12	910 pF	GRM2162C1H911JA01	MURATA MANUFACTURING CO.
C13	22 μF	UVZ1H220MDD	NICHICON CORPORATION
L1	37nH Enameled wire 7Turns, Diameter:0.4mm,φ2.46mm (the out side diameter)	4007C	Yoneda Processing Place Co.,Ltd.
R1	5.1 kΩ	RPC10 512-J	TAIYOSHA ELECTRIC CO.
R2	68 Ω	RPC05 680-J	TAIYOSHA ELECTRIC CO.

RD02LUS2

RoHS Compliance, Silicon MOSFET Power Transistor 470MHz, 2W, 3.6V

TYPICAL CHARACTERISTICS

(These are only typical curves and devices are not necessarily guaranteed at these curves.)

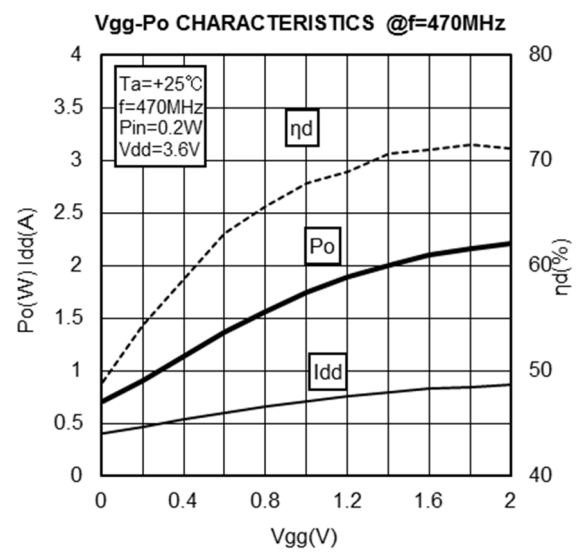
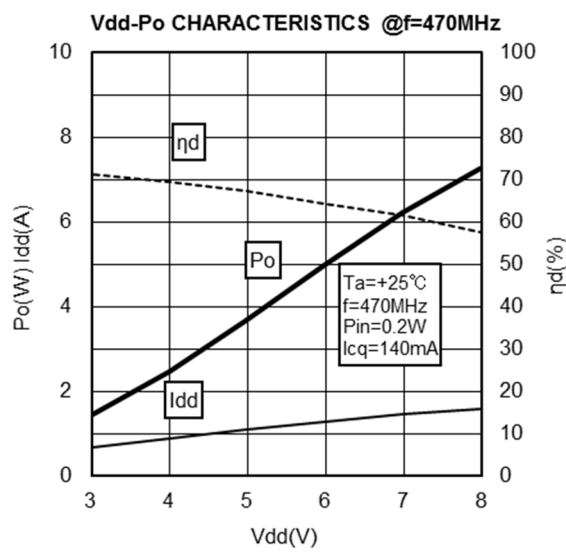
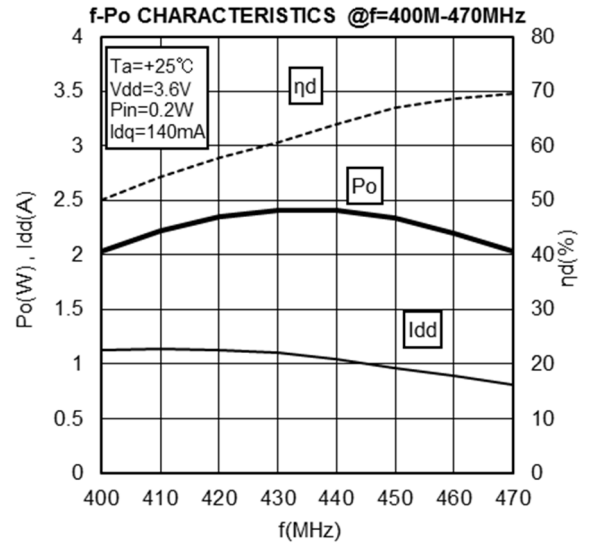
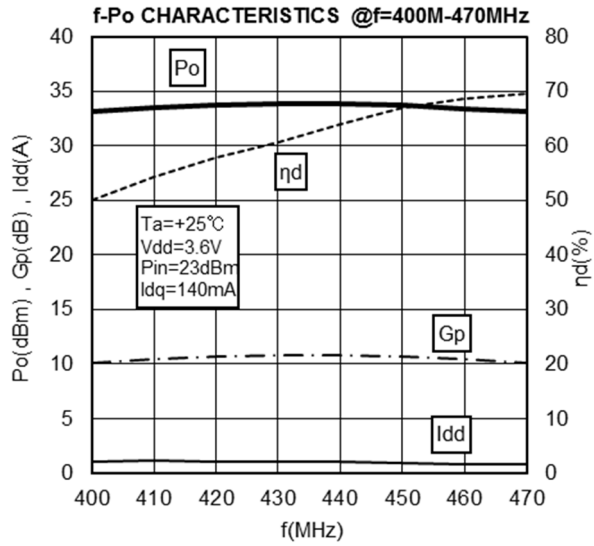

RD02LUS2

RoHS Compliance, Silicon MOSFET Power Transistor 470MHz, 2W, 3.6V

TYPICAL CHARACTERISTICS

(These are only typical curves and devices are not necessarily guaranteed at these curves.)

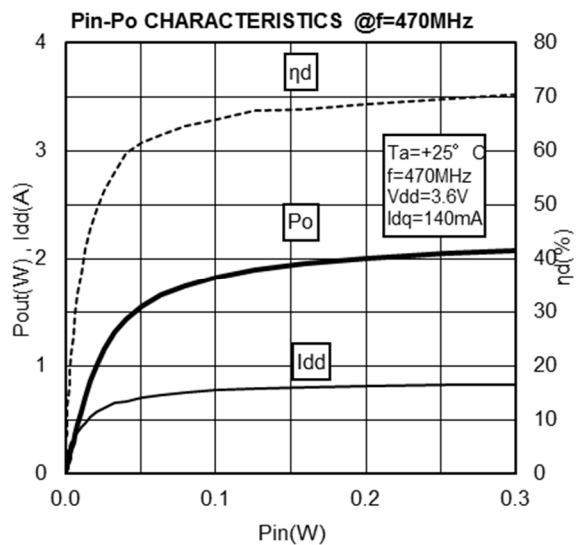
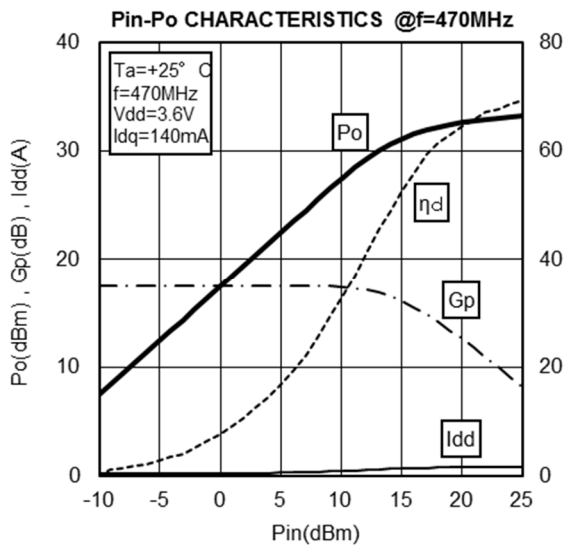
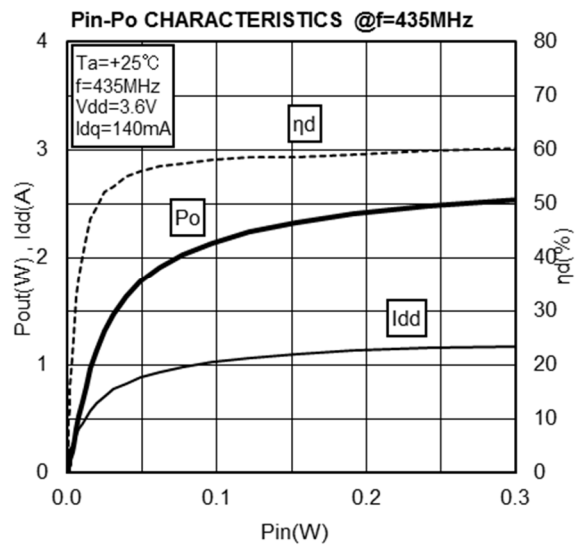
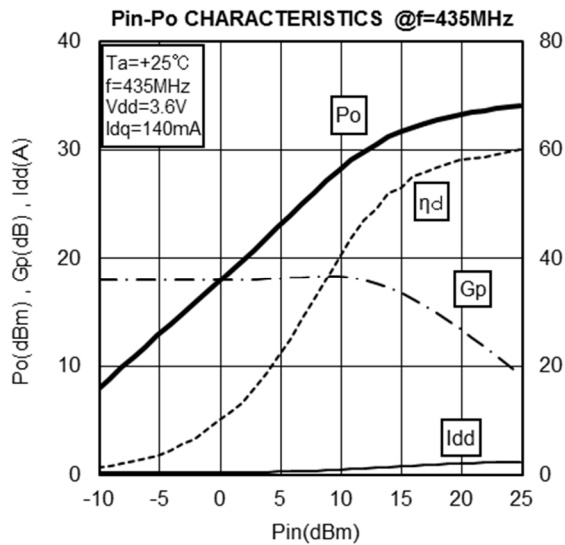
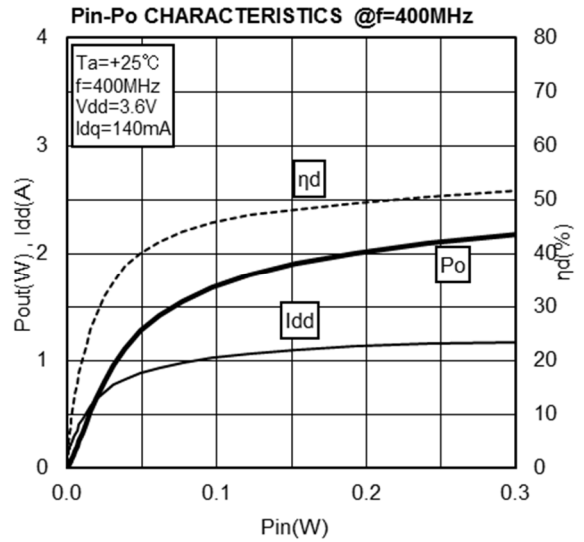
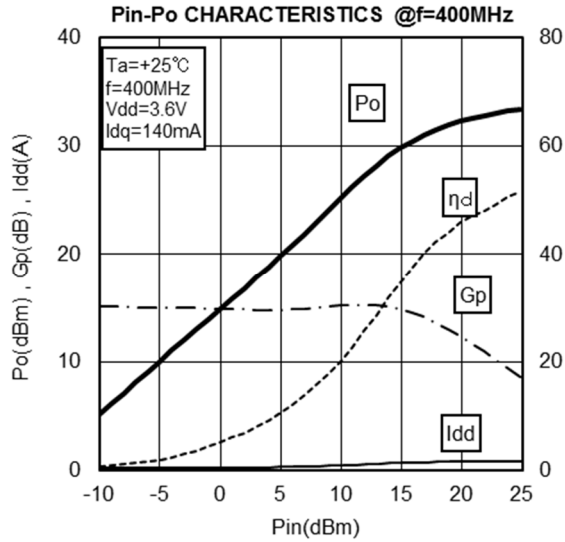

RD02LUS2

RoHS Compliance, Silicon MOSFET Power Transistor 470MHz, 2W, 3.6V

EQUIVALENT CIRCUITRY for UHF CIRCUIT (f=400-470MHz)

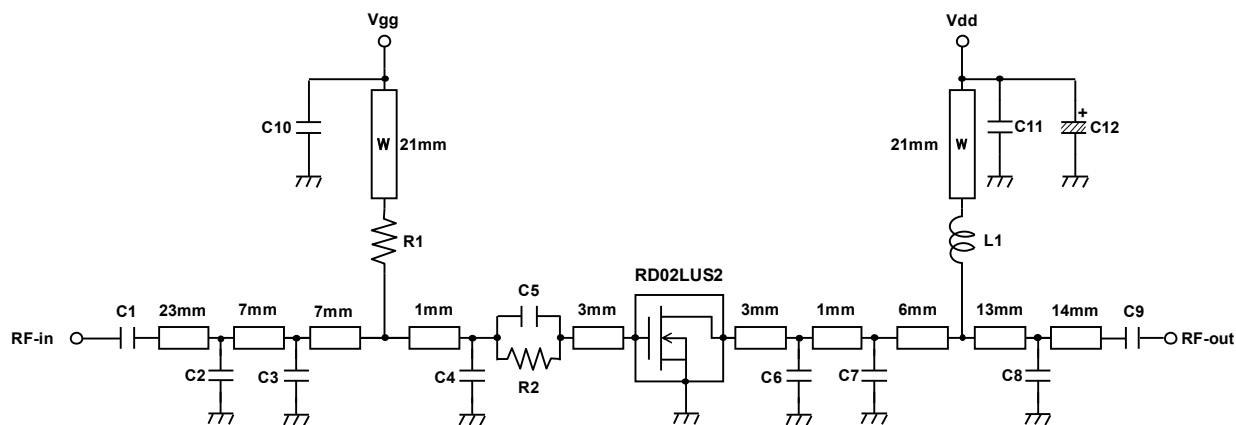

<Note>
 Board material: Glass-Epoxy Substrate($\epsilon_r=4.8$, $t=0.8\text{mm}$)
 Micro strip line width=1.3mm / 50 Ω
 W line width=1.0mm

Part	Description	Part number	Manufacturer
C1, C9	200 pF	GRM2162C1H201JA01	MURATA MANUFACTURING CO.
C2	15 pF	GRM2162C1H150JZ01	MURATA MANUFACTURING CO.
C3	20 pF	GRM2162C1H200JZ01	MURATA MANUFACTURING CO.
C4	43 pF	GRM2162C1H430JZ01	MURATA MANUFACTURING CO.
C5	100 pF	GRM1882C1H101JA01	MURATA MANUFACTURING CO.
C6, C7	24 pF	GQM2195C2E240JB12	MURATA MANUFACTURING CO.
C8	12 pF	GRM2162C1H120JZ01	MURATA MANUFACTURING CO.
C10, C11	910 pF	GRM2162C1H911JA01	MURATA MANUFACTURING CO.
C12	22 μF	UVZ1H220MDD	NICHICON CORPORATION
L1	37nH Enameled wire 7Turns, Diameter:0.4mm, ϕ 2.46mm (the out side diameter)	4007C	Yoneda Processing Place Co.,Ltd.
R1	5.1 k Ω	RPC10 512-J	TAIYOSHA ELECTRIC CO.
R2	68 Ω	RPC05 680-J	TAIYOSHA ELECTRIC CO.

RD02LUS2

RoHS Compliance, Silicon MOSFET Power Transistor 470MHz, 2W, 3.6V

INPUT / OUTPUT IMPEDANCE VS. FREQUENCY CHARACTERISTICS

Zin* (f=400, 435, 470MHz)

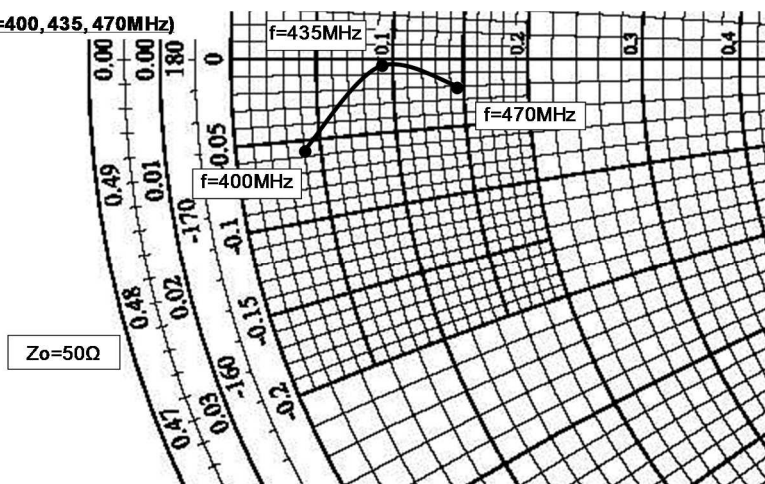

f (MHz)	Zin* (Ω)
400	3.44 - j 1.97
435	4.88 - j 0.49
470	6.80 - j 1.16

Zin*: Complex conjugate of input impedance

from drain to RF-out(50Ω port)

Zout* (f=400, 435, 470MHz)

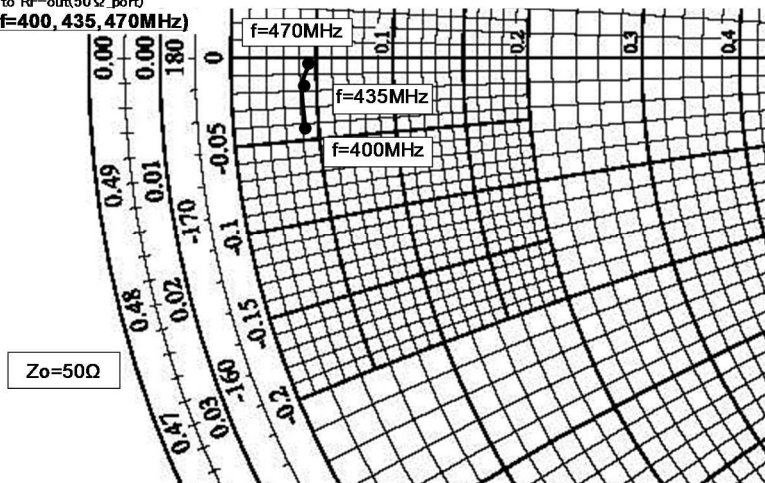

f (MHz)	Zout* (Ω)
400	2.06 - j 2.07
435	2.20 - j 0.99
470	2.33 - j 0.33

Zout*: Complex conjugate of output impedance

RD02LUS2

RoHS Compliance, Silicon MOSFET Power Transistor 470MHz, 2W, 3.6V

S-PARAMETER DATA($V_{DS}=3.6V$, $I_{dq}=140mA$)

Freq. (MHz)	S11		S21		S12		S22	
	(mag)	(ang)	(mag)	(ang)	(mag)	(ang)	(mag)	(ang)
100	0.76	-155	14.59	87	0.03	-2	0.70	-155
135	0.77	-160	10.70	80	0.02	-9	0.71	-159
155	0.77	-161	9.23	76	0.02	-12	0.72	-161
175	0.78	-163	8.09	73	0.02	-15	0.73	-162
200	0.79	-164	6.95	69	0.02	-18	0.74	-163
250	0.81	-166	5.34	62	0.02	-24	0.76	-164
300	0.82	-168	4.25	56	0.02	-29	0.79	-166
350	0.84	-169	3.47	51	0.02	-34	0.81	-167
400	0.86	-171	2.88	46	0.02	-38	0.83	-168
450	0.87	-172	2.43	42	0.02	-41	0.85	-169
500	0.88	-173	2.07	38	0.02	-44	0.86	-170
520	0.89	-174	1.95	36	0.01	-45	0.87	-171
530	0.89	-174	1.89	36	0.01	-45	0.87	-171
550	0.90	-174	1.78	34	0.01	-46	0.88	-172
600	0.91	-176	1.55	31	0.01	-49	0.89	-173
650	0.91	-177	1.36	28	0.01	-50	0.90	-174
700	0.92	-178	1.20	25	0.01	-52	0.91	-175
750	0.93	-179	1.07	23	0.01	-52	0.92	-176
800	0.93	-180	0.95	21	0.01	-52	0.93	-176
850	0.94	-179	0.86	18	0.01	-52	0.93	-177
900	0.94	-178	0.77	16	0.01	-52	0.94	-178
950	0.95	-177	0.70	14	0.01	-50	0.94	-179
1000	0.95	-177	0.64	13	0.00	-47	0.95	-180
1050	0.95	-176	0.59	11	0.00	-43	0.95	-179
1100	0.95	-175	0.54	9	0.00	-37	0.95	-179
1150	0.96	-174	0.49	8	0.00	-26	0.95	-178
1200	0.96	-173	0.46	6	0.00	-13	0.96	-177
1250	0.96	-172	0.42	5	0.00	3	0.96	-177
1300	0.96	-172	0.39	4	0.00	22	0.96	-176
1350	0.96	-171	0.36	3	0.00	36	0.96	-176
1400	0.96	-170	0.34	1	0.00	46	0.96	-175
1450	0.96	-169	0.32	0	0.00	54	0.96	-175
1500	0.96	-169	0.30	-1	0.00	61	0.96	-174

RD02LUS2

RoHS Compliance, Silicon MOSFET Power Transistor 470MHz, 2W, 3.6V

ATTENTION:

- 1.High Temperature ; This product might have a heat generation while operation,Please take notice that have a possibility to receive a burn to touch the operating product directly or touch the product until cold after switch off. At the near the product,do not place the combustible material that have possibilities to arise the fire.
- 2.Generation of High Frequency Power ; This product generate a high frequency power. Please take notice that do not leakage the unnecessary electric wave and use this products without cause damage for human and property per normal operation.
- 3.Before use; Before use the product,Please design the equipment in consideration of the risk for human and electric wave obstacle for equipment.

PRECAUTIONS FOR THE USE OF MITSUBISHI SILICON RF POWER DEVICES:

1. The specifications of mention are not guarantee values in this data sheet. Please confirm additional details regarding operation of these products from the formal specification sheet. For copies of the formal specification sheets, please contact one of our sales offices.
- 2.RA series products (RF power amplifier modules) and RD series products (RF power transistors) are designed for consumer mobile communication terminals and were not specifically designed for use in other applications. In particular, while these products are highly reliable for their designed purpose, they are not manufactured under a quality assurance testing protocol that is sufficient to guarantee the level of reliability typically deemed necessary for critical communications elements and In the application, which is base station applications and fixed station applications that operate with long term continuous transmission and a higher on-off frequency during transmitting, please consider the derating, the redundancy system, appropriate setting of the maintain period and others as needed. For the reliability report which is described about predicted operating life time of Mitsubishi Silicon RF Products , please contact Mitsubishi Electric Corporation or an authorized Mitsubishi Semiconductor product distributor.
3. RD series products use MOSFET semiconductor technology. They are sensitive to ESD voltage therefore appropriate ESD precautions are required.
4. In the case of use in below than recommended frequency, there is possibility to occur that the device is deteriorated or destroyed due to the RF-swing exceed the breakdown voltage.
5. In order to maximize reliability of the equipment, it is better to keep the devices temperature low. It is recommended to utilize a sufficient sized heat-sink in conjunction with other cooling methods as needed (fan, etc.) to keep the channel temperature for RD series products lower than 120deg/C(in case of Tchmax=150deg/C) ,140deg/C(in case of Tchmax=175deg/C) under standard conditions.
6. Do not use the device at the exceeded the maximum rating condition. In case of plastic molded devices, the exceeded maximum rating condition may cause blowout, smoldering or catch fire of the molding resin due to extreme short current flow between the drain and the source of the device. These results causes in fire or injury.
7. For specific precautions regarding assembly of these products into the equipment, please refer to the supplementary items in the specification sheet.
8. Warranty for the product is void if the products protective cap (lid) is removed or if the product is modified in any way from it's original form.
9. For additional "Safety first" in your circuit design and notes regarding the materials, please refer the last page of this data sheet.

RD02LUS2

RoHS Compliance, Silicon MOSFET Power Transistor 470MHz, 2W, 3.6V

10. Please avoid use in the place where water or organic solvents can adhere directly to the product and the environments with the possibility of caustic gas, dust, salinity, etc. Reliability could be markedly decreased and also there is a possibility failures could result causing a serious accident. Likewise, there is a possibility of causing a serious accident if used in an explosive gas environment. Please allow for adequate safety margin in your designs.

11. Please refer to the additional precautions in the formal specification sheet.

Keep safety first in your circuit designs!

Mitsubishi Electric Corporation puts the maximum effort into making semiconductor products better and more reliable, but there is always the possibility that trouble may occur with them. Trouble with semiconductors may lead to personal injury, fire or property damage. Remember to give due consideration to safety when making your circuit designs, with appropriate measures such as (i) placement of substitutive, auxiliary circuits, (ii) use of non-flammable material or (iii) prevention against any malfunction or mishap.

Notes regarding these materials

- These materials are intended as a reference to assist our customers in the selection of the Mitsubishi semiconductor product best suited to the customer's application; they do not convey any license under any intellectual property rights, or any other rights, belonging to Mitsubishi Electric Corporation or a third party.
- Mitsubishi Electric Corporation assumes no responsibility for any damage, or infringement of any third-party's rights, originating in the use of any product data, diagrams, charts, programs, algorithms, or circuit application examples contained in these materials.
- All information contained in these materials, including product data, diagrams, charts, programs and algorithms represents information on products at the time of publication of these materials, and are subject to change by Mitsubishi Electric Corporation without notice due to product improvements or other reasons. It is therefore recommended that customers contact Mitsubishi Electric Corporation or an authorized Mitsubishi Semiconductor product distributor for the latest product information before purchasing a product listed herein. The information described here may contain technical inaccuracies or typographical errors. Mitsubishi Electric Corporation assumes no responsibility for any damage, liability, or other loss rising from these inaccuracies or errors. Please also pay attention to information published by Mitsubishi Electric Corporation by various means, including the Mitsubishi Semiconductor home page (<http://www.MitsubishiElectric.com/>).
- When using any or all of the information contained in these materials, including product data, diagrams, charts, programs, and algorithms, please be sure to evaluate all information as a total system before making a final decision on the applicability of the information and products. Mitsubishi Electric Corporation assumes no responsibility for any damage, liability or other loss resulting from the information contained herein.
- Mitsubishi Electric Corporation semiconductors are not designed or manufactured for use in a device or system that is used under circumstances in which human life is potentially at stake. Please contact Mitsubishi Electric Corporation or an authorized Mitsubishi Semiconductor product distributor when considering the use of a product contained herein for any specific purposes, such as apparatus or systems for transportation, vehicular, medical, aerospace, nuclear, or undersea repeater use.
- The prior written approval of Mitsubishi Electric Corporation is necessary to reprint or reproduce in whole or in part these materials.
- If these products or technologies are subject to the Japanese export control restrictions, they must be exported under a license from the Japanese government and cannot be imported into a country other than the approved destination. Any diversion or re-export contrary to the export control laws and regulations of Japan and/or the country of destination is prohibited.
- Please contact Mitsubishi Electric Corporation or an authorized Mitsubishi Semiconductor product distributor for further details on these materials or the products contained therein.