

**ELECTROSTATIC SENSITIVE DEVICE**  
OBSERVE HANDLING PRECAUTIONS

MITSUBISHI RF POWER MOS FET

# RD02MUS1

RoHS Compliance, Silicon MOSFET Power Transistor 175MHz, 520MHz, 2W

## DESCRIPTION

RD02MUS1 is a MOS FET type transistor specifically designed for VHF/UHF RF power amplifiers applications.

## FEATURES

High power gain:  
 $P_{out} > 2W$ ,  $G_p > 16dB$   
 @  $V_{dd} = 7.2V$ ,  $f = 175MHz, 520MHz$   
 High Efficiency: 65%typ. (175MHz)  
 High Efficiency: 65%typ. (520MHz)

## APPLICATION

For output stage of high power amplifiers  
 In VHF/UHF band mobile radio sets.

## OUTLINE DRAWING

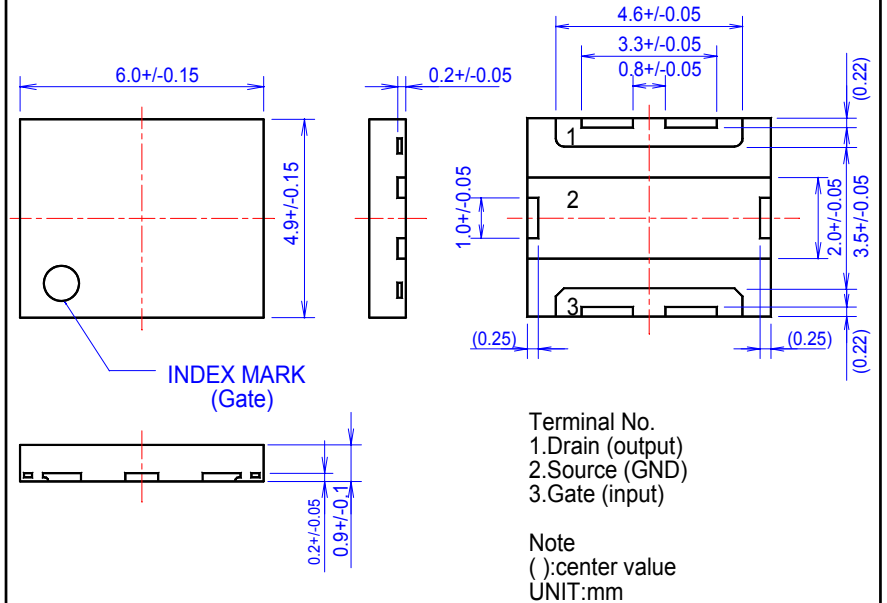

## RoHS COMPLIANT

RD02MUS1-101, T112 is a RoHS compliant products.  
 RoHS compliance is indicate by the letter "G" after the Lot Marking.  
 This product include the lead in high melting temperature type solders.  
 How ever, it applicable to the following exceptions of RoHS Directions.  
 1. Lead in high melting temperature type solders (i.e. tin-lead solder alloys containing more than 85% lead.)

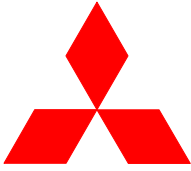

**ELECTROSTATIC SENSITIVE DEVICE**  
OBSERVE HANDLING PRECAUTIONS

MITSUBISHI RF POWER MOS FET

# RD02MUS1

RoHS Compliance, Silicon MOSFET Power Transistor 175MHz, 520MHz, 2W

## ABSOLUTE MAXIMUM RATINGS

(T<sub>c</sub>=25°C UNLESS OTHERWISE NOTED)

SYMBOL	PARAMETER	CONDITIONS	RATINGS	UNIT
VDSS	Drain to source voltage	V <sub>gs</sub> =0V	30	V
VGSS	Gate to source voltage	V <sub>ds</sub> =0V	+/-20	V
P <sub>ch</sub>	Channel dissipation	T <sub>c</sub> =25°C	21.9	W
P <sub>in</sub>	Input Power	Z <sub>g</sub> =Z <sub>l</sub> =50Ω	0.1	W
I <sub>D</sub>	Drain Current	-	1.5	A
T <sub>ch</sub>	Junction temperature	-	150	°C
T <sub>stg</sub>	Storage temperature	-	-40 to +125	°C
R <sub>th j-c</sub>	Thermal resistance	Junction to case	5.7	°C/W

Note 1: Above parameters are guaranteed independently.

## ELECTRICAL CHARACTERISTICS (T<sub>c</sub>=25°C, UNLESS OTHERWISE NOTED)

SYMBOL	PARAMETER	CONDITIONS	LIMITS			UNIT
			MIN	TYP	MAX.	
I <sub>DSS</sub>	Zero gate Voltage drain current	V <sub>DS</sub> =17V, V <sub>GS</sub> =0V	-	-	100	μA
I <sub>GSS</sub>	Gate to source leak current	V <sub>GS</sub> =10V, V <sub>DS</sub> =0V	-	-	1	μA
V <sub>th</sub>	Gate threshold Voltage	V <sub>DS</sub> =12V, I <sub>DS</sub> =1mA	1	1.8	3	V
P <sub>out1</sub>	Output power	V <sub>DD</sub> =7.2V, P <sub>in</sub> =50mW,	2	3	-	W
η <sub>D1</sub>	Drain efficiency	f=175MHz I <sub>dq</sub> =200mA				
P <sub>out2</sub>	Output power	V <sub>DD</sub> =7.2V, P <sub>in</sub> =50mW,	2	3	-	W
η <sub>D2</sub>	Drain efficiency	f=520MHz I <sub>dq</sub> =200mA				
	Load VSWR tolerance	V <sub>DD</sub> =9.2V, P <sub>o</sub> =2W(PinControl) f=175MHz, I <sub>dq</sub> =200mA, Z <sub>g</sub> =50Ω Load VSWR=20:1(All Phase)	No destroy			-
	Load VSWR tolerance	V <sub>DD</sub> =9.2V, P <sub>o</sub> =2W(PinControl) f=520MHz, I <sub>dq</sub> =200mA, Z <sub>g</sub> =50Ω Load VSWR=20:1(All Phase)	No destroy			-

Note : Above parameters , ratings , limits and conditions are subject to change.

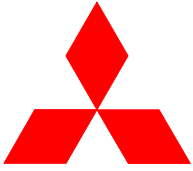

**ELECTROSTATIC SENSITIVE DEVICE**  
OBSERVE HANDLING PRECAUTIONS

MITSUBISHI RF POWER MOS FET

# RD02MUS1

RoHS Compliance, Silicon MOSFET Power Transistor 175MHz, 520MHz, 2W

## TYPICAL CHARACTERISTICS

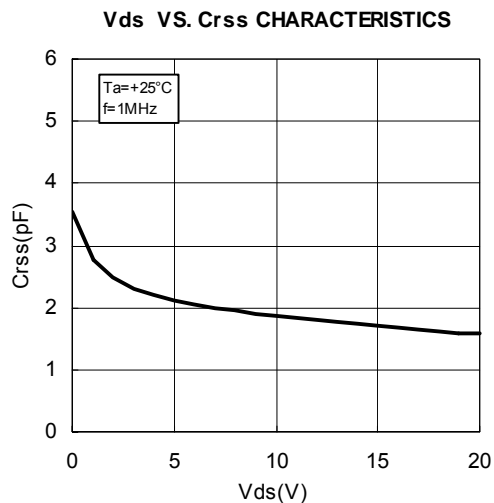
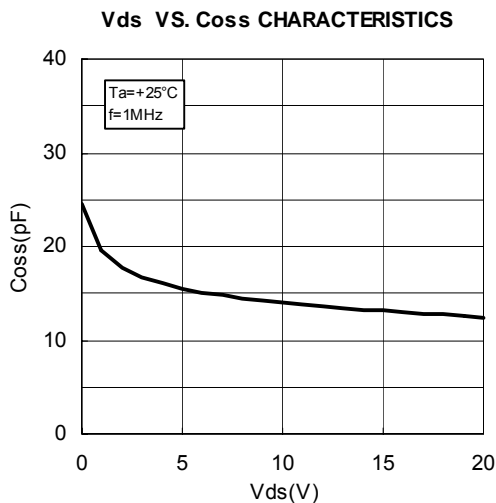
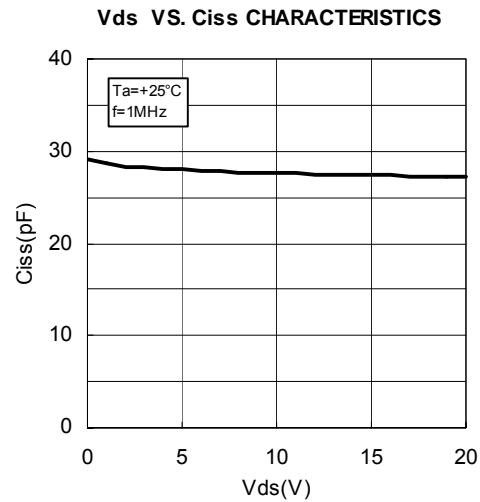
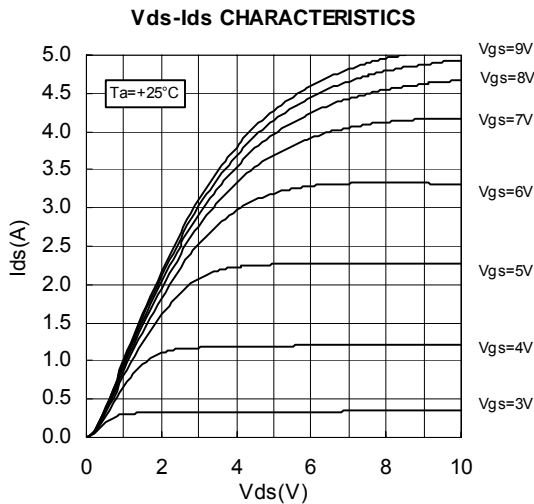
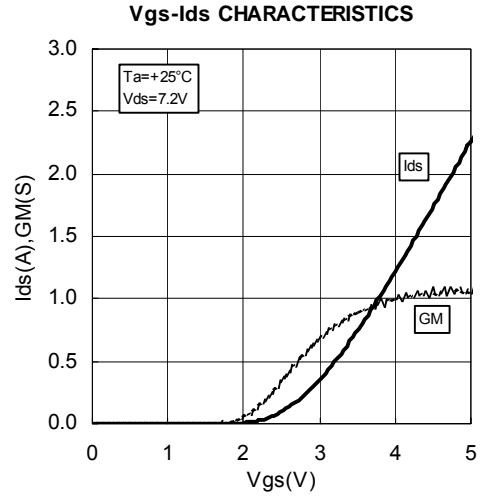
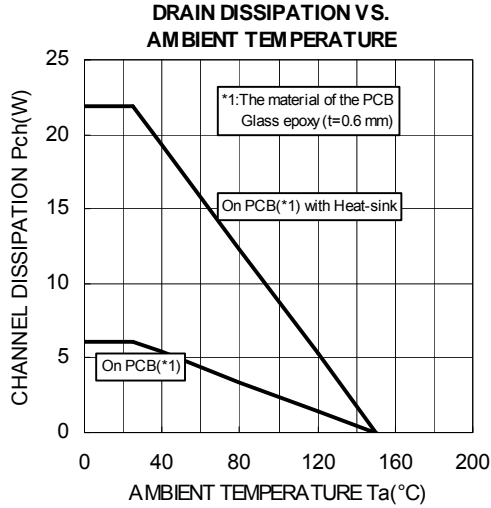



**ELECTROSTATIC SENSITIVE DEVICE**  
OBSERVE HANDLING PRECAUTIONS

MITSUBISHI RF POWER MOS FET

**RD02MUS1**

RoHS Compliance, Silicon MOSFET Power Transistor 175MHz, 520MHz, 2W

**TYPICAL CHARACTERISTICS**

**Pin-Po CHARACTERISTICS**  
@f=175MHz

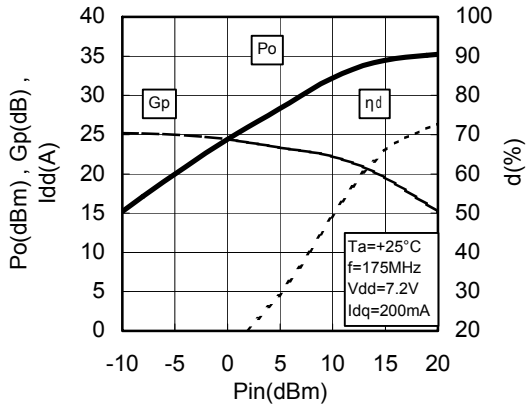

**Pin-Po CHARACTERISTICS**  
@f=175MHz

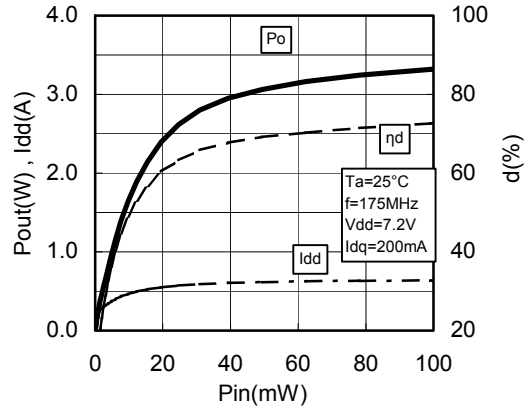

**Pin-Po CHARACTERISTICS**  
@f=520MHz

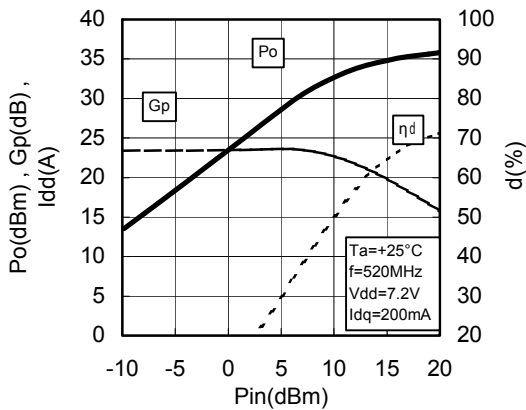

**Pin-Po CHARACTERISTICS**  
@f=520MHz

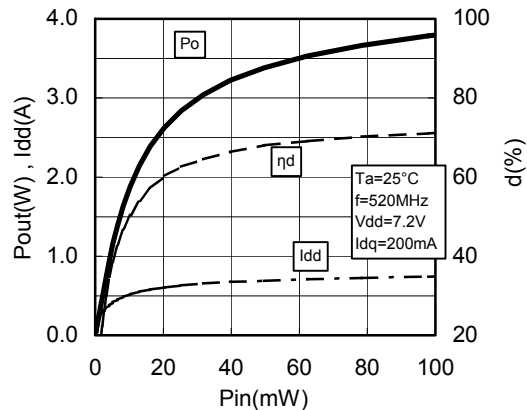

**Vdd-Po CHARACTERISTICS**  
@f=175MHz

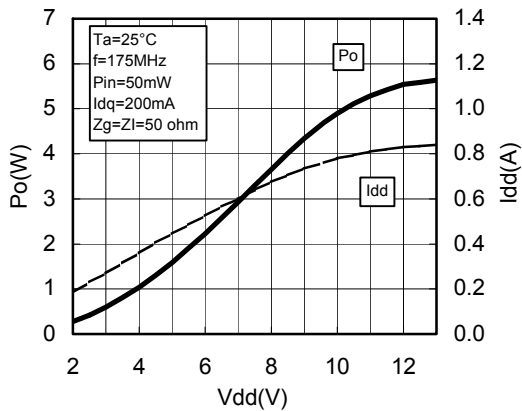

**Vdd-Po CHARACTERISTICS**  
@f=520MHz

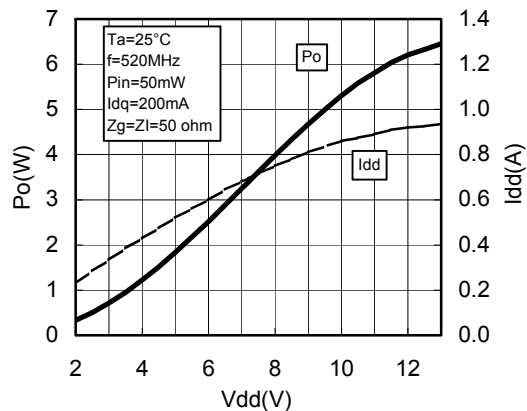

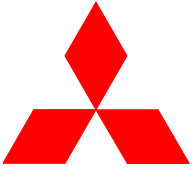

ELECTROSTATIC SENSITIVE DEVICE  
OBSERVE HANDLING PRECAUTIONS

MITSUBISHI RF POWER MOS FET

# RD02MUS1

RoHS Compliance, Silicon MOSFET Power Transistor 175MHz, 520MHz, 2W

## TYPICAL CHARACTERISTICS

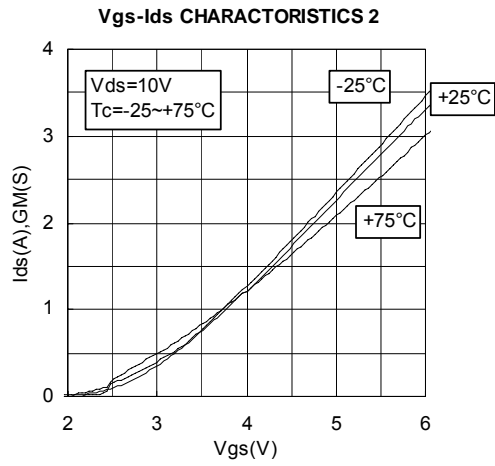



**ELECTROSTATIC SENSITIVE DEVICE**  
OBSERVE HANDLING PRECAUTIONS

**MITSUBISHI RF POWER MOS FET**

**RD02MUS1**

**RoHS Compliance, Silicon MOSFET Power Transistor 175MHz, 520MHz, 2W**

**TEST CIRCUIT(f=175MHz)**

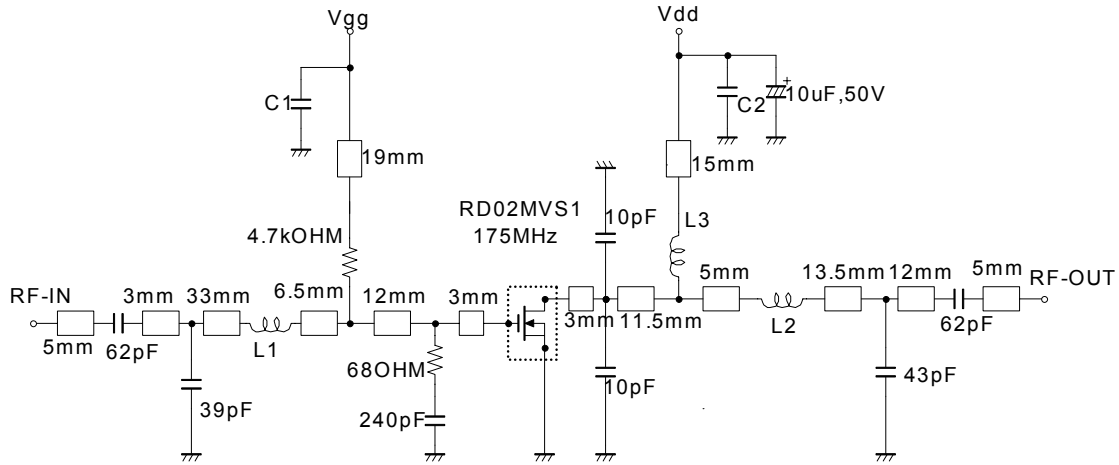

L1: Enameled wire 5Turns,D:0.43mm,2.46mmO.D  
L2: Enameled wire 3Turns,D:0.43mm,2.46mmO.D  
L3: Enameled wire 9Turns,D:0.43mm,2.46mmO.D  
C1,C2:1000pF,0.0022uF in parallel

Note:Board material-Teflon substrate  
Micro strip line width=2.2mm/50OHM,er:2.7,t=0.8mm

**TEST CIRCUIT(f=520MHz)**

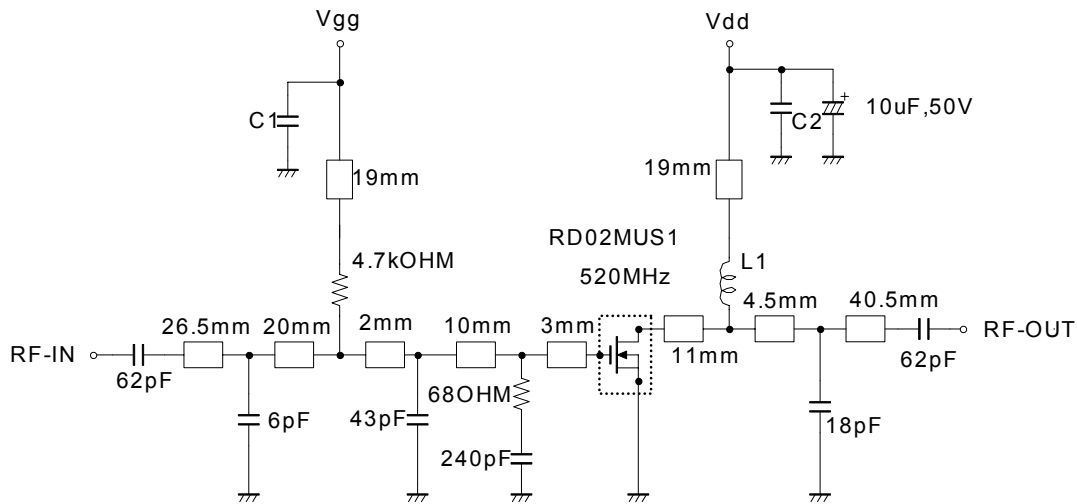

L1: Enameled wire 9Turns,D:0.43mm,2.46mmO.D  
C1,C2:1000pF,0.022uF in parallel

Note:Board material-Teflon substrate  
Micro strip line width=2.2mm/50OHM,er:2.7,t=0.8mm



ELECTROSTATIC SENSITIVE DEVICE  
OBSERVE HANDLING PRECAUTIONS

MITSUBISHI RF POWER MOS FET

# RD02MUS1

RoHS Compliance, Silicon MOSFET Power Transistor 175MHz, 520MHz, 2W

## INPUT/OUTPUT IMPEDANCE VS. FREQUENCY CHARACTERISTICS

175MHz  $Z_{in}^*$   $Z_{out}^*$   
 $Z_o=50\Omega$

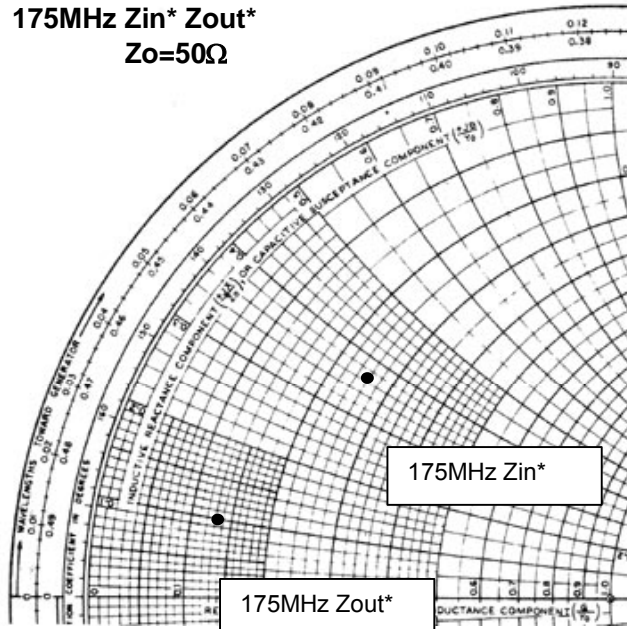

$V_{dd}=7.2V$ ,  $I_{dq}=200mA$ ( $V_{gg}$  adj.),  $P_{in}=0.05W$

$Z_{in}^*=11.61+j17.88$   
 $Z_{out}^*=6.83+j5.21$

$Z_{in}^*$ : Complex conjugate of input impedance  
 $Z_{out}^*$ : Complex conjugate of input impedance

520MHz  $Z_{in}^*$   $Z_{out}^*$   
 $Z_o=50\Omega$

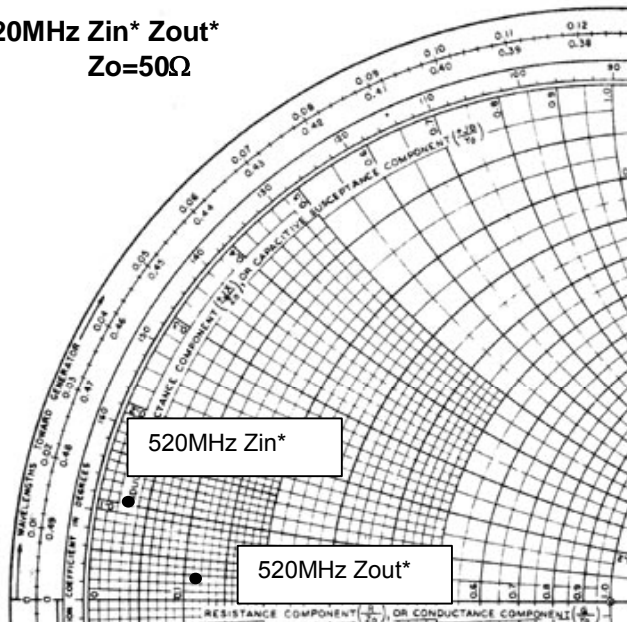

$V_{dd}=7.2V$ ,  $I_{dq}=200mA$ ( $V_{gg}$  adj.),  $P_{in}=0.05W$

$Z_{in}^*=1.20+j5.47$   
 $Z_{out}^*=5.56+j1.31$

$Z_{in}^*$ : Complex conjugate of input impedance  
 $Z_{out}^*$ : Complex conjugate of input impedance



**ELECTROSTATIC SENSITIVE DEVICE**  
OBSERVE HANDLING PRECAUTIONS

MITSUBISHI RF POWER MOS FET

# RD02MUS1

RoHS Compliance, Silicon MOSFET Power Transistor 175MHz, 520MHz, 2W

RD02MSU1 S-PARAMETER DATA (@Vdd=7.5V, Id=200mA)

Freq. [MHz]	S11		S21		S12		S22	
	(mag)	(ang)	(mag)	(ang)	(mag)	(ang)	(mag)	(ang)
100	0.814	-132.9	16.154	102.5	0.039	14.9	0.591	-125.5
150	0.807	-147.2	11.503	92.9	0.040	5.9	0.585	-138.6
175	0.804	-151.6	9.965	89.3	0.040	2.7	0.586	-142.6
200	0.804	-154.8	8.689	86.2	0.040	-0.1	0.590	-145.5
250	0.806	-159.4	6.872	81.1	0.039	-4.3	0.606	-149.3
300	0.812	-162.6	5.687	76.5	0.038	-8.2	0.621	-151.7
350	0.817	-164.9	4.749	72.3	0.036	-11.4	0.639	-153.5
400	0.824	-166.8	4.078	69.3	0.035	-13.2	0.659	-155.2
450	0.830	-168.5	3.560	65.2	0.033	-16.8	0.677	-156.6
500	0.837	-169.7	3.087	62.8	0.031	-17.4	0.697	-157.8
520	0.840	-170.3	2.960	61.9	0.030	-17.9	0.705	-158.4
550	0.844	-171.1	2.767	59.8	0.030	-19.1	0.715	-159.2
600	0.851	-172.3	2.439	57.1	0.028	-20.9	0.731	-160.6
650	0.857	-173.3	2.196	55.2	0.025	-20.9	0.747	-161.8
700	0.862	-174.4	1.987	52.6	0.024	-21.9	0.763	-162.9
750	0.869	-175.5	1.796	51.0	0.022	-23.3	0.773	-164.3
800	0.873	-176.6	1.632	49.1	0.020	-21.9	0.787	-165.5
850	0.879	-177.5	1.520	47.6	0.019	-20.4	0.799	-166.5
900	0.882	-178.5	1.366	45.3	0.017	-21.1	0.806	-167.7
950	0.886	-179.6	1.281	45.6	0.015	-18.4	0.818	-169.0
1000	0.889	179.5	1.197	42.5	0.014	-17.2	0.826	-170.0
1050	0.891	178.4	1.077	42.1	0.012	-11.9	0.832	-171.1
1100	0.896	177.2	1.047	41.3	0.011	-6.6	0.840	-172.6

RD02MSU1 S-PARAMETER DATA (@Vdd=12.5V, Id=200mA)

Freq. [MHz]	S11		S21		S12		S22	
	(mag)	(ang)	(mag)	(ang)	(mag)	(ang)	(mag)	(ang)
100	0.829	-127.5	16.693	104.9	0.037	17.6	0.557	-118.4
150	0.820	-143.3	12.079	94.6	0.039	7.8	0.550	-132.5
175	0.817	-148.2	10.504	90.7	0.039	4.3	0.551	-136.7
200	0.815	-151.8	9.178	87.5	0.038	1.1	0.556	-139.9
250	0.817	-157.0	7.273	82.0	0.037	-2.9	0.574	-144.2
300	0.822	-160.7	6.018	77.3	0.036	-7.1	0.592	-146.8
350	0.827	-163.3	5.033	72.8	0.035	-10.7	0.613	-149.0
400	0.833	-165.5	4.317	69.6	0.033	-12.6	0.636	-150.9
450	0.838	-167.3	3.772	65.5	0.032	-16.2	0.656	-152.5
500	0.846	-168.8	3.269	63.0	0.030	-16.9	0.678	-153.9
520	0.848	-169.3	3.132	62.0	0.029	-17.4	0.686	-154.6
550	0.852	-170.2	2.928	59.8	0.028	-18.7	0.698	-155.5
600	0.858	-171.6	2.582	57.1	0.026	-20.3	0.716	-157.0
650	0.863	-172.6	2.324	55.1	0.024	-21.1	0.733	-158.5
700	0.868	-173.8	2.102	52.5	0.023	-21.8	0.750	-159.7
750	0.874	-175.0	1.899	50.8	0.021	-24.5	0.761	-161.2
800	0.879	-176.1	1.726	48.8	0.019	-21.5	0.777	-162.6
850	0.884	-177.1	1.606	47.3	0.017	-21.5	0.789	-163.7
900	0.888	-178.2	1.445	45.0	0.016	-21.1	0.798	-165.0
950	0.890	-179.3	1.351	45.2	0.014	-18.0	0.810	-166.5
1000	0.894	179.8	1.265	42.1	0.013	-15.9	0.818	-167.5
1050	0.895	178.6	1.138	41.6	0.011	-11.0	0.825	-168.7
1100	0.899	177.5	1.104	40.9	0.010	-4.9	0.833	-170.3



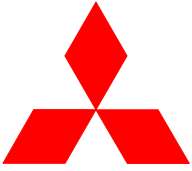

**ELECTROSTATIC SENSITIVE DEVICE**  
OBSERVE HANDLING PRECAUTIONS

MITSUBISHI RF POWER MOS FET

# RD02MUS1

RoHS Compliance, Silicon MOSFET Power Transistor 175MHz, 520MHz, 2W

---

Keep safety first in your circuit designs!

Mitsubishi Electric Corporation puts the maximum effort into making semiconductor products better and more reliable, but there is always the possibility that trouble may occur with them. Trouble with semiconductors may lead to personal injury, fire or property damage. Remember to give due consideration to safety when making your circuit designs, with appropriate measures such as (i) placement of substitutive, auxiliary circuits, (ii) use of non-flammable material or (iii) prevention against any malfunction or mishap.

**warning !**

Do not use the device at the exceeded the maximum rating condition. In case of plastic molded devices, the exceeded maximum rating condition may cause blowout, smoldering or catch fire of the molding resin due to extreme short current flow between the drain and the source of the device. These results causes in fire or injury.