

**Phase-out/Discontinued**

# RD2.0E to RD120E

## 500 mW PLANAR TYPE SILICON ZENER DIODES

### DESCRIPTION

These products are zener diodes with an allowable dissipation of 500 mW and a planar type glass sealed DHD (double heatsink diode) structure.

### FEATURES

- The zener voltage series has a wide voltage range of 2 to 120 V and is ideal for standardization.
- The E24 series is employed for the zener voltage nominal value.

### ORDERING INFORMATION

Any of the B1 to B7 voltage classifications are available for customers who request the B grade product of the RD2.0E to RD39E.

### APPLICATIONS

- Zener voltage and constant-current circuit
- Waveform clipper circuit and limiter circuit
- Surge absorption circuit

### PACKAGE DRAWING (Unit: mm)

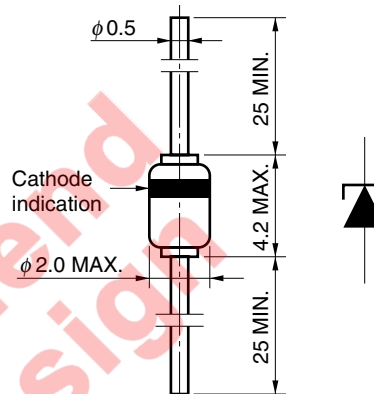

Marking color: Black  
JEDEC: DO-35

### ABSOLUTE MAXIMUM RATINGS (T<sub>A</sub> = 25°C)

Parameter	Symbol	Ratings	Unit	Remarks
Power dissipation	P	500	mW	
Junction temperature	T <sub>i</sub>	175	°C	
Forward current	I <sub>F</sub>	200	mA	
Storage temperature	T <sub>stg</sub>	-65 to +175	°C	
Surge reverse power	P <sub>RSM</sub>	100 (t = 100 μs)	W	Refer to Figure 6.

The information in this document is subject to change without notice. Before using this document, please confirm that this is the latest version.  
Not all products and/or types are available in every country. Please check with an NEC Electronics sales representative for availability and additional information.

**ELECTRICAL CHARACTERISTICS (T<sub>A</sub> = 25°C)**

Type Number	Suffix	Zener Voltage V <sub>Z</sub> (V) <sup>Note 1</sup>			Dynamic Impedance Z <sub>Z</sub> (Ω) <sup>Note 2</sup>		Knee Dynamic Impedance Z <sub>ZK</sub> (Ω) <sup>Note 2</sup>		Reverse Current I <sub>R</sub> (μA)		Zener Voltage Temperature Coefficient γ <sub>Z</sub> (mV/°C)	
		MIN.	MAX.	I <sub>Z</sub> (mA)	MAX.	I <sub>Z</sub> (mA)	MAX.	I <sub>Z</sub> (mA)	MAX.	I <sub>Z</sub> (mA)	TYP.	I <sub>Z</sub> (mA)
RD2.0E	B	1.88	2.20	20	140	20	2000	1	120	0.5	-1.0	20
	B1	1.88	2.10									
	B2	2.02	2.20									
RD2.2E	B	2.12	2.41	20	120	20	2000	1	120	0.7	-1.5	20
	B1	2.12	2.30									
	B2	2.22	2.41									
RD2.4E	B	2.33	2.63	20	100	20	2000	1	120	1.0	-1.5	20
	B1	2.33	2.52									
	B2	2.43	2.63									
RD2.7E	B	2.54	2.91	20	100	20	1000	1	100	1.0	-1.5	20
	B1	2.54	2.75									
	B2	2.69	2.91									
RD3.0E	B	2.85	3.22	20	80	20	1000	1	50	1.0	-2.0	20
	B1	2.85	3.07									
	B2	3.01	3.22									
RD3.3E	B	3.16	3.53	20	70	20	1000	1	20	1.0	-2.0	20
	B1	3.16	3.38									
	B2	3.32	3.53									
RD3.6E	B	3.47	3.83	20	60	20	1000	1	10	1.0	-2.0	20
	B1	3.47	3.68									
	B2	3.62	3.83									
RD3.9E	B	3.77	4.14	20	50	20	1000	1	5	1.0	-2.0	20
	B1	3.77	3.98									
	B2	3.92	4.14									
RD4.3E	B	4.05	4.53	20	40	20	1000	1	5	1.0	-1.5	20
	B1	4.05	4.26									
	B2	4.20	4.40									
	B3	4.34	4.53									
RD4.7E	B	4.47	4.91	20	25	20	900	1	5	1.0	-1.0	20
	B1	4.47	4.65									
	B2	4.59	4.77									
	B3	4.71	4.91									
RD5.1E	B	4.85	5.35	20	20	20	800	1	5	1.5	0.5	20
	B1	4.85	5.03									
	B2	4.97	5.18									
	B3	5.12	5.35									
RD5.6E	B	5.29	5.88	20	13	20	500	1	5	2.5	1.5	20
	B1	5.29	5.52									
	B2	5.46	5.70									
	B3	5.64	5.88									
RD6.2E	B	5.81	6.40	20	10	20	300	1	5	3.0	2.0	20
	B1	5.81	6.06									
	B2	5.99	6.24									
	B3	6.16	6.40									

★

Type Number	Suffix	Zener Voltage Vz (V) <sup>Note 1</sup>			Dynamic Impedance Zz (Ω) <sup>Note 2</sup>		Knee Dynamic Impedance Zzk (Ω) <sup>Note 2</sup>		Reverse Current Ir (μA)		Zener Voltage Temperature Coefficient γz (mV/°C)	
		MIN.	MAX.	Iz (mA)	MAX.	Iz (mA)	MAX.	Iz (mA)	MAX.	Iz (mA)	TYP.	Iz (mA)
RD6.8E	B	6.32	6.97	20	8	20	150	0.5	2	3.5	2.5	20
	B1	6.32	6.59									
	B2	6.52	6.79									
	B3	6.70	6.97									
RD7.5E	B	6.88	7.64	20	8	20	120	0.5	0.5	4.0	3.0	20
	B1	6.88	7.19									
	B2	7.11	7.41									
	B3	7.33	7.64									
RD8.2E	B	7.56	8.41	20	8	20	120	0.5	0.5	5.0	4.0	20
	B1	7.56	7.90									
	B2	7.82	8.15									
	B3	8.07	8.41									
RD9.1E	B	8.33	9.29	20	8	20	120	0.5	0.5	6.0	4.5	20
	B1	8.33	8.70									
	B2	8.61	8.99									
	B3	8.89	9.29									
RD10E	B	9.19	10.30	20	8	20	120	0.5	0.2	7.0	5.5	20
	B1	9.19	9.59									
	B2	9.48	9.90									
	B3	9.82	10.30									
RD11E	B	10.18	11.26	10	10	10	120	0.5	0.2	8.0	6.5	10
	B1	10.18	10.63									
	B2	10.50	10.95									
	B3	10.82	11.26									
RD12E	B	11.13	12.30	10	12	10	110	0.5	0.2	9.0	7.5	10
	B1	11.13	11.63									
	B2	11.50	11.92									
	B3	11.80	12.30									
RD13E	B	12.18	13.62	10	14	10	110	0.5	0.2	10	8.5	10
	B1	12.18	12.71									
	B2	12.59	13.16									
	B3	13.03	13.62									
RD15E	B	13.48	15.02	10	16	10	110	0.5	0.2	11	10	10
	B1	13.48	14.09									
	B2	13.95	14.56									
	B3	14.42	15.02									
RD16E	B	14.87	16.50	10	18	10	150	0.5	0.2	12	11	10
	B1	14.87	15.50									
	B2	15.33	15.93									
	B3	15.79	16.50									
RD18E	B	16.34	18.30	10	23	10	150	0.5	0.2	13	13	10
	B1	16.34	17.06									
	B2	16.90	17.67									
	B3	17.51	18.30									

★

Type Number	Suffix	Zener Voltage Vz (V) <sup>Note 1</sup>			Dynamic Impedance Zz (Ω) <sup>Note 2</sup>		Knee dynamic Impedance Zzk (Ω) <sup>Note 2</sup>		Reverse Current IR (μA)		Zener Voltage Temperature Coefficient γz (mV/°C)		★
		MIN.	MAX.	Iz (mA)	MAX.	Iz (mA)	MAX.	Iz (mA)	MAX.	Iz (mA)	TYP.	Iz (mA)	
RD20E	B	18.11	20.72	10	28	10	200	0.5	0.2	15	15	10	
	B1	18.11	18.92										
	B2	18.73	19.57										
	B3	19.38	20.22										
	B4	19.88	20.72										
RD22E	B	20.23	22.61	5	30	5	200	0.5	0.2	17	17	5	
	B1	20.23	21.08										
	B2	20.76	21.65										
	B3	21.22	22.09										
	B4	21.68	22.61										
RD24E	B	22.26	24.81	5	35	5	200	0.5	0.2	19	19	5	
	B1	22.26	23.12										
	B2	22.75	23.73										
	B3	23.29	24.27										
	B4	23.81	24.81										
RD27E	B	24.26	27.64	5	45	5	250	0.5	0.2	21	21	5	
	B1	24.26	25.52										
	B2	24.97	26.26										
	B3	25.63	26.95										
	B4	26.29	27.64										
RD30E	B	26.99	30.51	5	55	5	250	0.5	0.2	23	24	5	
	B1	26.99	28.39										
	B2	27.70	29.13										
	B3	28.36	29.82										
	B4	29.02	30.51										
RD33E	B	29.68	33.11	5	65	5	250	0.5	0.2	25	26	5	
	B1	29.68	31.22										
	B2	30.32	31.88										
	B3	30.90	32.50										
	B4	31.49	33.11										
RD36E	B	32.14	35.77	5	75	5	250	0.5	0.2	27	29	5	
	B1	32.14	33.79										
	B2	32.79	34.49										
	B3	33.40	35.13										
	B4	34.01	35.77										
R39E	B	34.68	40.80	5	85	5	250	0.5	0.2	30	32	5	
	B1	34.68	36.47										
	B2	35.36	37.19										
	B3	36.00	37.85										
	B4	36.63	38.52										
	B5	37.36	39.29										
	B6	38.14	40.11										
	B7	38.94	40.80										

- Notes**
1. The zener voltage (Vz) of the B and B1 to B7 grades is tested for 40 ms after power ON.
  2. The operation resistance (Zz, Zzk) is tested by superimposing a micro AC on the standard current (Iz).

**Remark** The B grade is a composition of the B1 to B7 grades. Any of the B1 to B7 voltage classifications are available for customers who request the B grade product.

Type Number	Suffix	Zener Voltage V <sub>z</sub> (V) <sup>Note 1</sup>			Dynamic Impedance Z <sub>z</sub> (Ω) <sup>Note 2</sup>		Reverse Current I <sub>R</sub> (μA)		Zener Voltage Temperature Coefficient γ <sub>z</sub> (mV/°C)	
		MIN.	MAX.	I <sub>z</sub> (mA)	MAX.	I <sub>z</sub> (mA)	MAX.	I <sub>z</sub> (mA)	TYP.	I <sub>z</sub> (mA)
RD43E	B	40	45	5	90	5	0.2	33	37	5
RD47E	B	44	49	5	90	5	0.2	36	41	5
RD51E	B	48	54	5	110	5	0.2	39	45	5
RD56E	B	53	60	5	110	5	0.2	43	51	5
RD62E	B	58	66	2	200	2	0.2	47	56	2
RD68E	B	64	72	2	200	2	0.2	52	62	2
RD75E	B	70	79	2	300	2	0.2	57	69	2
RD82E	B	77	87	2	300	2	0.2	63	76	2
RD91E	B	85	96	2	400	2	0.2	69	85	2
RD100E	B	94	106	2	400	2	0.2	76	95	2
RD110E	B	104	116	1	750	1	0.2	84	105	1
RD120E	B	114	126	1	900	1	0.2	91	115	1

★

- Notes**
1. The zener voltage (V<sub>z</sub>) is tested for 40 ms after power ON.
  2. The operation resistance (Z<sub>z</sub>) is tested by superimposing a micro AC on the standard current (I<sub>z</sub>).

Not recommended for new design

TYPICAL CHARACTERISTICS (TA = 25°C)

Figure 1. P vs. TA Rating

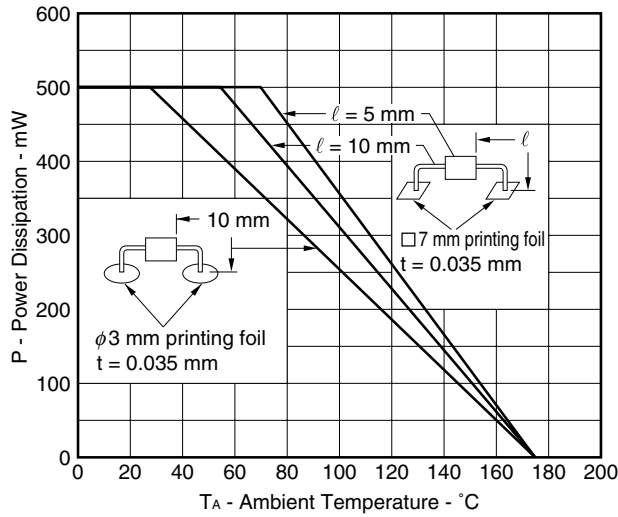

Figure 2. Rth vs. S Example of Characteristics

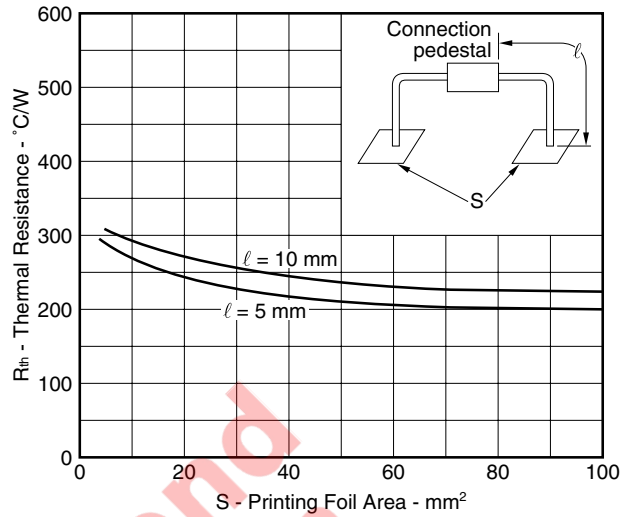
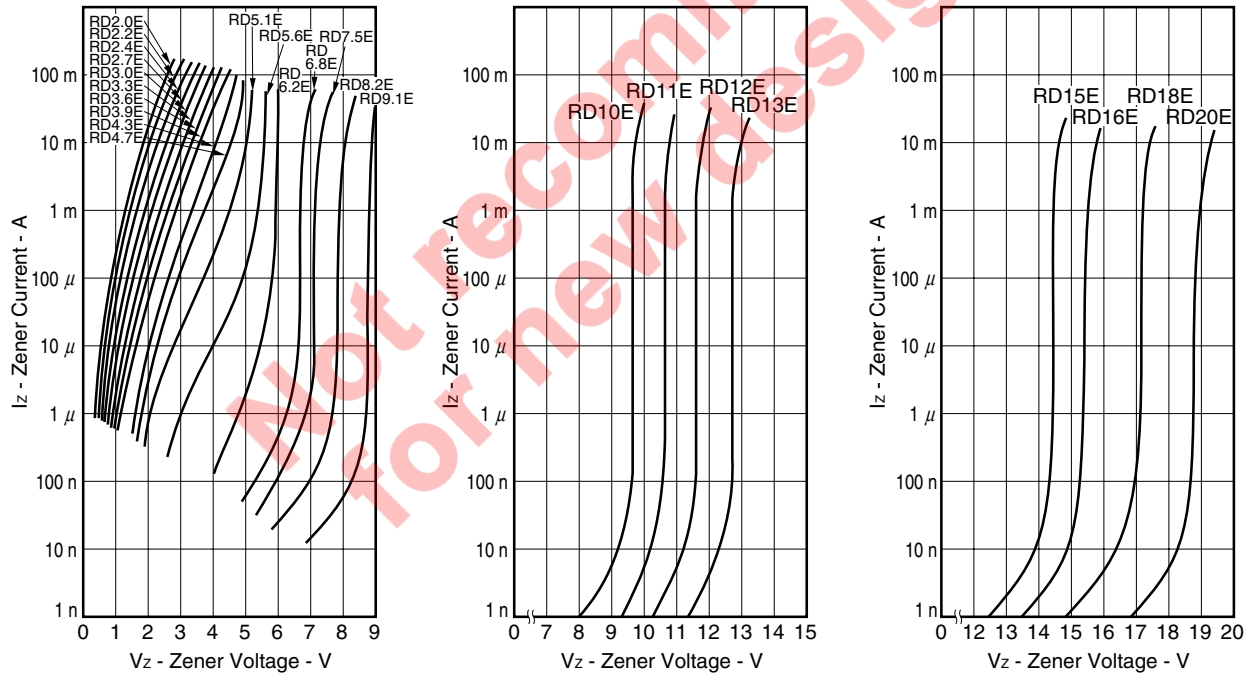

Figure 3. Iz vs. Vz Rating



(a)

(b)

(c)

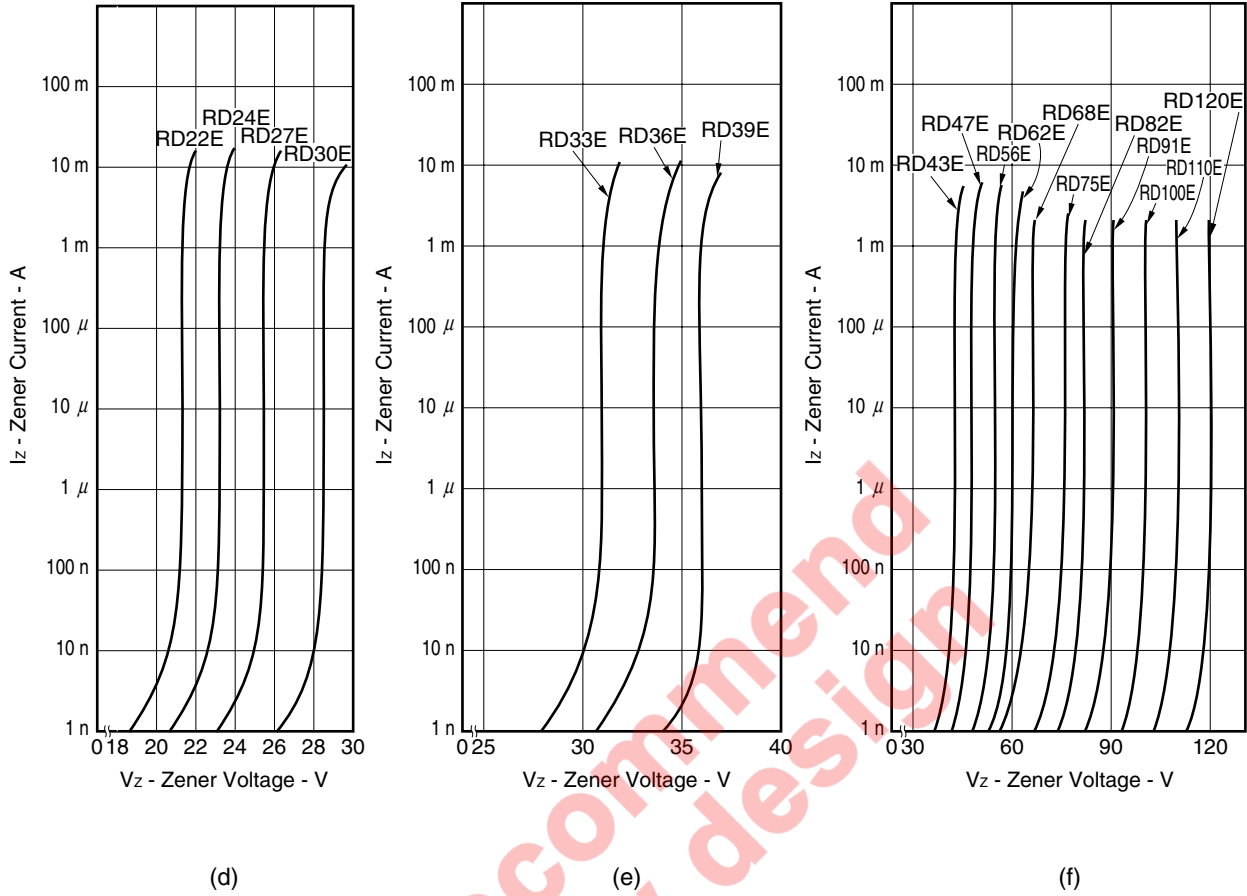

Figure 4. Zz vs. Iz Example of Characteristics

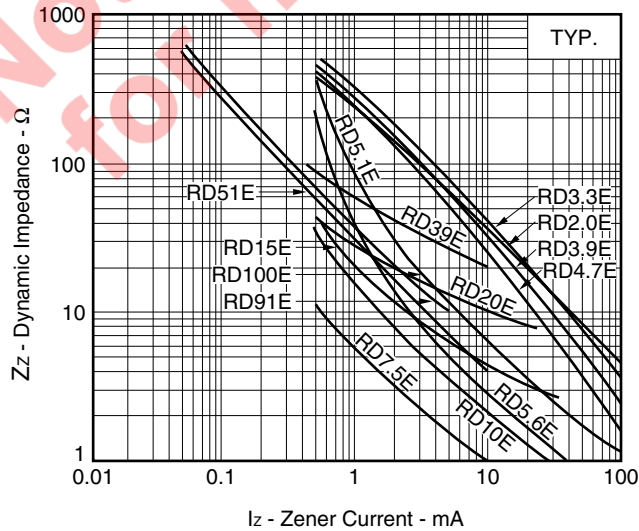

Figure 5.  $\gamma_z$  vs.  $V_z$  Example of Characteristics

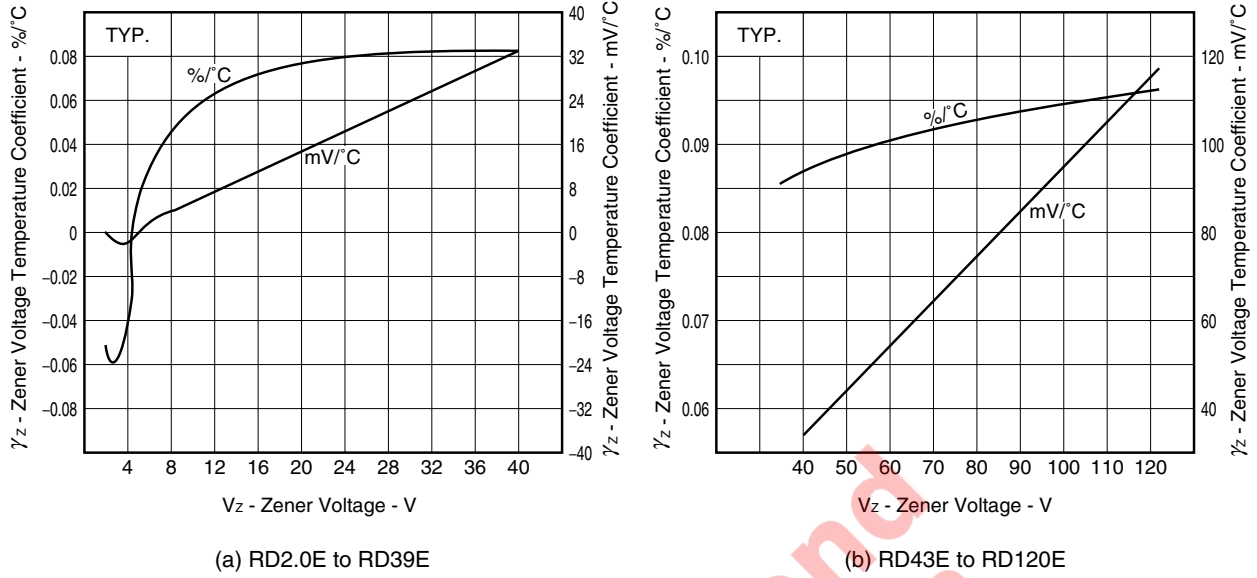

Figure 6. Surge Reverse Power Rating

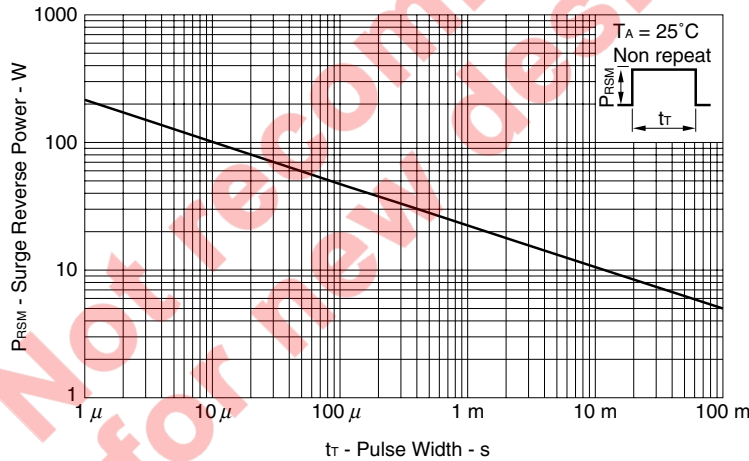
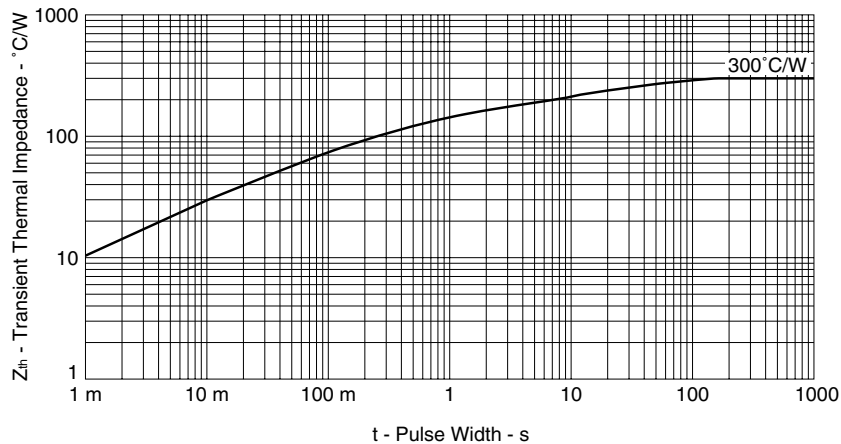

Figure 7. Transient Heat Thermal Impedance





- **The information in this document is current as of December, 2004. The information is subject to change without notice. For actual design-in, refer to the latest publications of NEC Electronics data sheets or data books, etc., for the most up-to-date specifications of NEC Electronics products. Not all products and/or types are available in every country. Please check with an NEC Electronics sales representative for availability and additional information.**
- No part of this document may be copied or reproduced in any form or by any means without the prior written consent of NEC Electronics. NEC Electronics assumes no responsibility for any errors that may appear in this document.
- NEC Electronics does not assume any liability for infringement of patents, copyrights or other intellectual property rights of third parties by or arising from the use of NEC Electronics products listed in this document or any other liability arising from the use of such products. No license, express, implied or otherwise, is granted under any patents, copyrights or other intellectual property rights of NEC Electronics or others.
- Descriptions of circuits, software and other related information in this document are provided for illustrative purposes in semiconductor product operation and application examples. The incorporation of these circuits, software and information in the design of a customer's equipment shall be done under the full responsibility of the customer. NEC Electronics assumes no responsibility for any losses incurred by customers or third parties arising from the use of these circuits, software and information.
- While NEC Electronics endeavors to enhance the quality, reliability and safety of NEC Electronics products, customers agree and acknowledge that the possibility of defects thereof cannot be eliminated entirely. To minimize risks of damage to property or injury (including death) to persons arising from defects in NEC Electronics products, customers must incorporate sufficient safety measures in their design, such as redundancy, fire-containment and anti-failure features.
- NEC Electronics products are classified into the following three quality grades: "Standard", "Special" and "Specific".

The "Specific" quality grade applies only to NEC Electronics products developed based on a customer-designated "quality assurance program" for a specific application. The recommended applications of an NEC Electronics product depend on its quality grade, as indicated below. Customers must check the quality grade of each NEC Electronics product before using it in a particular application.

"Standard": Computers, office equipment, communications equipment, test and measurement equipment, audio and visual equipment, home electronic appliances, machine tools, personal electronic equipment and industrial robots.

"Special": Transportation equipment (automobiles, trains, ships, etc.), traffic control systems, anti-disaster systems, anti-crime systems, safety equipment and medical equipment (not specifically designed for life support).

"Specific": Aircraft, aerospace equipment, submersible repeaters, nuclear reactor control systems, life support systems and medical equipment for life support, etc.

The quality grade of NEC Electronics products is "Standard" unless otherwise expressly specified in NEC Electronics data sheets or data books, etc. If customers wish to use NEC Electronics products in applications not intended by NEC Electronics, they must contact an NEC Electronics sales representative in advance to determine NEC Electronics' willingness to support a given application.

(Note)

- (1) "NEC Electronics" as used in this statement means NEC Electronics Corporation and also includes its majority-owned subsidiaries.
- (2) "NEC Electronics products" means any product developed or manufactured by or for NEC Electronics (as defined above).